



RADIO'S LIVEST MAGAZINE

Special  
Television  
Number

# Radio-Craft

HUGO GERNSBACK Editor

August  
25 Cents  
In United States  
and Canada

TELEVISION NEWS SERVICE

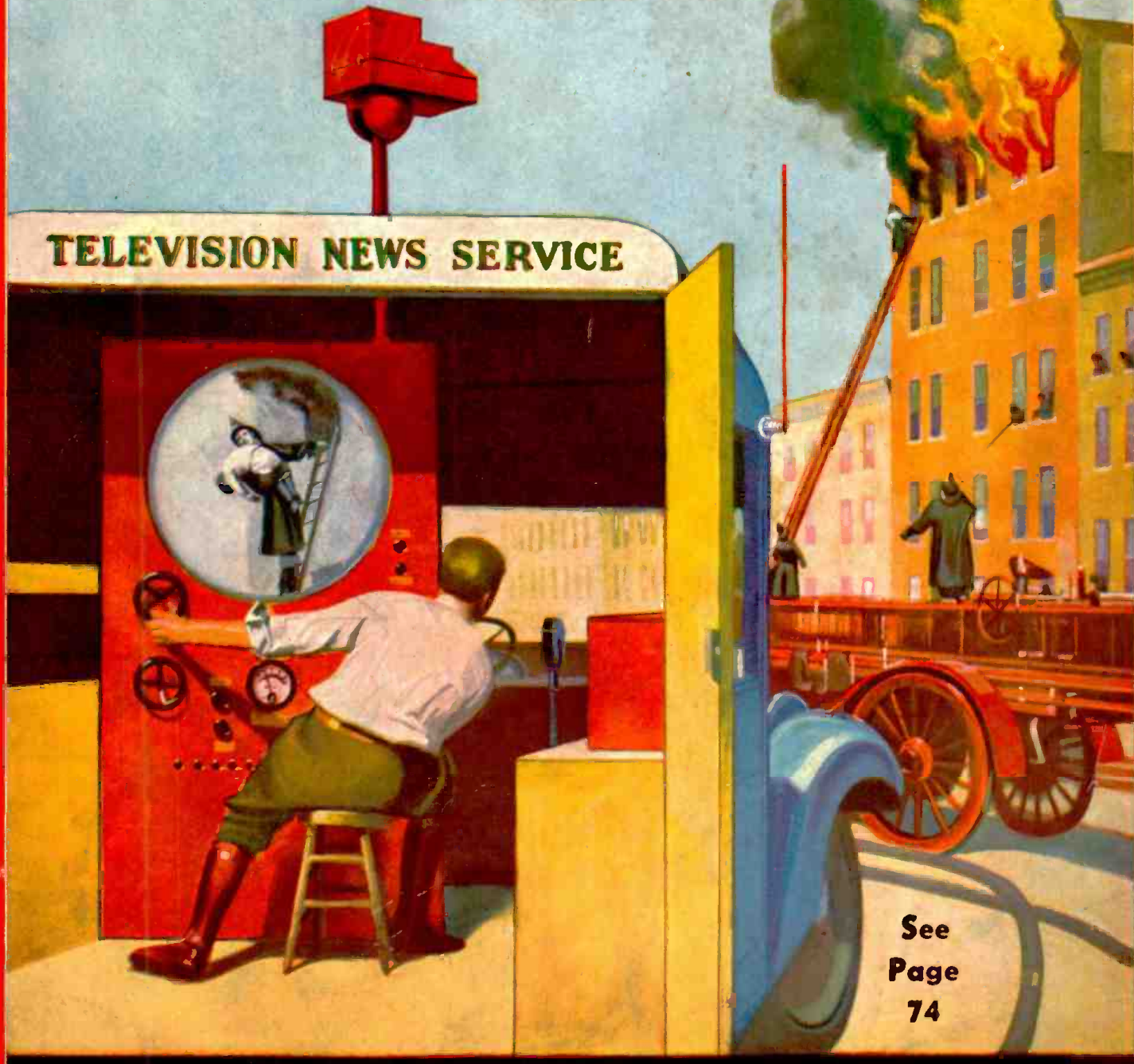

See  
Page  
74

New Television Developments — "Pee-Wee" Multi-Range Meter — Beginner's "2"  
Lee DeForest — Sanabria — Priess — Goldsmith — Don Lee — Peck — Farnsworth

OVER 200 ILLUSTRATIONS



339 De Luxe  
Analyzer

89 De Luxe  
Tube Tester

**I WILL GIVE YOU BOTH  
THESE SUPREME  
INSTRUMENTS FOR ONLY  
\$9<sup>50</sup> DOWN + \$8<sup>49</sup> PER MONTH**

*Your Parts  
Jobber*

**189 SIGNAL GENERATOR**

Supreme 189 Signal Generator — both modulated and unmodulated — self-contained 400 cycle audio oscillator — unusual frequency stability through special electron-coupled circuit — carrier frequencies directly calibrated. Only \$4.00 DOWN and \$3.66 PER MONTH.



It is no longer necessary to save money to buy a SUPREME. Get the instrument now and pay for it on the easiest possible terms while you use it. Ask your Parts Jobber or write the factory about the S. I. C. Easy Payment Plan. Everybody's doing it!

**SUPREME INSTRUMENTS CORP. GREENWOOD MISS., U. S. A.**  
EXPORT DEPT., ASSOCIATED EXPORTERS CO., 145 W. 45th STREET, NEW YORK, N. Y., CABLE ADDRESS: LOPREH, N. Y.

# OPPORTUNITIES *are many* for the Radio Trained Man



Don't be an untrained man. Let me show you how to get your start in Radio—the fastest growing, livest money-making game on earth.

## Jobs Leading to Salaries of \$35 a Week and Up

Prepare for jobs as Designer, Inspector and Tester—as Radio Salesman and in Service and Installation Work—or for work in a Broadcasting Station—as Wireless Operator on a Ship or Airplane, or in Talking Picture or Sound Work—HUNDREDS OF OPPORTUNITIES for a real future in Radio!

## Ten Weeks of Shop Training Pay Your Tuition After Graduation

We don't teach by book study. We train you on a great outlay of Radio, Television and Sound equipment—on scores of modern Radio Receivers, huge Broadcasting equipment, Television apparatus, Talking Picture and Sound Reproduction equipment, Code Practice equipment, etc. You don't need advanced education or previous experience. We give you—RIGHT HERE IN THE COYNE SHOPS—the actual practice and experience you'll need for your start in this great field. And because we cut out all useless theory and only give that which is necessary you get a practical training in 10 weeks.

# TELEVISION *and* TALKING PICTURES

And Television is already here! Soon there'll be a demand for THOUSANDS of TELEVISION EXPERTS! The man who learns Television now can have a great future in this great new field. Get in on the ground-floor of this amazing new Radio development! Come to COYNE and learn Television as it should be learned on Television equipment. Talking Picture and Public Address Systems offer opportunities to the Trained Radio Man. Here is a great new Radio field just beginning to grow! Prepare NOW for these wonderful opportunities! Learn Radio Sound Work at COYNE on actual Talking Picture and Sound Reproduction equipment.

## PAY FOR YOUR TRAINING After You Graduate

I am making an offer that no other school has dared to do. I mean exactly what I say. You can get a complete training by the world's oldest and largest Practical Radio School and I'll finance your Tuition. You won't have to start paying me back in small, monthly payments until 2 months after your required training period is over. I consider the fellow who is ambitious enough to want to get ahead by taking my Training, worthy of my help. MAIL THE COUPON BELOW, and you can prove to me that you are willing to spend just TEN WEEKS in the Coyne Training Shops Learning RADIO. Then, I'll tell you how I finance your Tuition—give you your complete Training and let you pay me back later.

I've got enough confidence in ambitious fellows and in my methods to give them the training they need and let them pay me back after they have completed their training.

### ELECTRIC REFRIGERATION AIR CONDITIONING

To assure your thorough preparation for a prosperous future, I include—at no extra cost—a course in Electric Refrigeration and Air Conditioning, taught you by personal instruction and actual work on latest-type equipment.

### ALL PRACTICAL WORK At COYNE in Chicago

ALL ACTUAL, PRACTICAL WORK. You build radio sets, install and service them. You actually operate great Broadcasting equipment. You construct Television Receiving Sets and actually transmit your own Television programs over our Television equip-

ment. You work on real Talking Picture machines and Sound equipment. You learn Wireless Operating on Actual Code Practice apparatus. We don't waste time on useless theory. We give you the practical training you'll need—in 10 short, pleasant weeks.

### MANY EARN WHILE LEARNING

You get Free Employment Service for Life. And don't let lack of money stop you—my plan makes it possible to get Coyne training with very little money. Many of our students make all or a good part of their living expenses while going to school and if you should need this help just write to me. Coyne is 36 years old. Coyne Training is tested—proved beyond all doubt. You can find out everything absolutely free. Just mail coupon for my big free book!

H. C. Lewis, Pres. RADIO DIVISION Founded 1899

## Coyne Electrical School

500 S. Paulina St., Dept. C6-8H, Chicago, Ill.

Mail Coupon Today for All the Facts

H. C. LEWIS, President

Radio Division, Coyne Electrical School

500 S. Paulina St., Dept. C6-8H, Chicago, Ill.

Dear Mr. Lewis:—Send me your Big Free Radio Book, and all details of your Special Offer, including Electric Refrigeration, Air Conditioning courses and your "Pay After Graduation" offer.

Name \_\_\_\_\_

Address \_\_\_\_\_

City \_\_\_\_\_ State \_\_\_\_\_

Please Say That You Saw It in RADIO-CRAFT



HUGO GERNSBACK, Editor-in-Chief  
 C. W. PALMER Associate Editor  
 H. G. McENTEE Associate Editor  
 R. D. WASHBURNE, Technical Editor

## CONTENTS-AUG., 1936, ISSUE

Volume VIII Number 2

Editorial: Television Problems.....	Hugo Gernsback	69
The Radio Month in Review.....		70
What About Television?.....	W. E. Schrage	72
New Developments in Television.....	R. D. Washburne	74
High-Intensity Illuminants in Television .....	Dr. Lee deForest	76
Television on the West Coast.....	Don Lee	76
Radio Pictorial .....		77
International Radio Review.....		78
The Importance of Interlaced Scanning..	U. A. Sanabria	79
Mechanical vs. Cathode-Ray Systems of Television .....	William H. Priess	79
Television as Home Entertainment .....	Dr. Alfred N. Goldsmith	80
A New Variable-Attenuation Equalizer .....	S. Floyd Stewart	80
High-Fidelity Wired Sound.....	N. H. Lessem	81
The "Elf"—A 2-Tube Set for the Beginner .....	C. W. Palmer	82
The "Transceptor"—A New Idea in 5-Meter Trans- ceivers .....	Frank Lester	83
Television in Germany.....	Karl Tetzner	83
The Latest Radio Tubes.....		84
How to Install a Wired Audio P.A. System—Part I .....	E. A. Dennis	84
Reflections of a Radio Service Man's Wife .....	Aileen Iodice	85
Television Progress in Italy.....		86

Short-Cuts in Radio.....		87
Making a Midget Multi-Purpose Meter..	H. G. McEntee	88
The Opto-Mechanical System of Television .....	Wm. Hoyt Peck	88
Operating Notes .....		89
Electronic Music Fundamentals—Part IV..	Edward Kassel	90
A French Television System.....	Marc Chauvierre	91
A Dual-Modulated Beat Signal Generator..	E. L. Garrett	91
An Improved Television Camera.....	Philo T. Farnsworth	92
The Design of Modern Test Equipment—Part V .....	Samuel C. Milbourne	92
How to Make an Oscilloscope—Part II .....	Charles Sicuranza	93
A Cathode-Ray Film Scanner.....	A. Stager	94
Making a Precision Aligning Unit—Part III .....	Canio Maggio	94
Readers' Dept. ....		95
The Latest Radio Equipment.....		96

### RADIO-SERVICE DATA SHEETS:

No. 172—Zenith Model 7M91 7-Tube "Safety" Auto Superheterodyne; Howard 6-Tube Series I Auto Superhet.....	98
No. 173—RCA Victor Model 236-B 7-Tube Battery Superhet. Receiver; Midwest Model 14-37 14-Tube All-Wave Superhet. No. 174—Belmont Model 522 5-Tube 2 V. Battery Superheterodyne; Belmont 666 6-Tube Superhet. Auto-Radio Receiver	101
ORSMMA Members' Forum.....	100
Book Reviews .....	121

## ANNUAL SET BUILDER'S NUMBER

New tube developments and new circuit tricks have intrigued the set builders who have written articles for the forthcoming issue of RADIO-CRAFT. Small sets, medium sets and large sets will be described for the man who wants to do his own construction work. Sets will be included for both beginners and old timers.

Also, the usual departments will be carried, plus interesting construction and technical articles for the Service Man. Public address specialists will also find that their interests have been taken care of. Ask your newsdealer today to reserve for you a copy of this Sept. (newsstands—Aug. 1) 1936 issue of RADIO-CRAFT.

HUGO GERNSBACK, President I. S. MANHEIMER, Secretary  
 Published by Continental Publications, Inc. Publication office: 29  
 Worthington Street, Springfield, Mass. Editorial and Advertising  
 Office: 99 Hudson Street, New York City. Chicago Advertising  
 Office: L. F. McClure, 919 North Michigan Avenue, Chicago, Ill.  
 Western Advertising Office: Loyd B. Chappell, 511 So. Alexandria St.,  
 Los Angeles, Calif.

#### European Agents:

London—Gorrings American News Agency, 9A Green St., Leices-  
 ter Square, London, W. C. 2.  
 Paris—Messageries Dawson, 4 Rue Faubourg, Poissonnière, Paris,  
 France.  
 Australian Agent: McGill's Agency, 179 Elizabeth St., Melbourne.

RADIO-CRAFT is published monthly, on the first of the month preced-  
 ing that of date; subscription price is \$2.50 per year in U. S. and Can-  
 ada. (In foreign countries, \$3.00 a year to cover additional postage.)  
 Entered at the post office at Springfield as second-class matter  
 under the act of March 3, 1879.

Text and illustrations of this magazine are copyright and must not be  
 reproduced without permission of the copyright owners. We are also  
 agents for EVERYDAY SCIENCE AND MECHANICS. Subscription  
 to this magazine may be taken in combination with RADIO-CRAFT  
 at reduced Club rates. Write for information.

Copyright 1936. Continental Publications, Inc.



**YES-** I'M CONVINCED THAT I CAN MAKE GOOD MONEY IN RADIO. I'M GOING TO START TRAINING FOR RADIO RIGHT NOW.

**NO-** NOT ME. I'M NOT GOING TO WASTE MY TIME. SUCCESS IS JUST A MATTER OF LUCK AND I WASN'T BORN LUCKY.

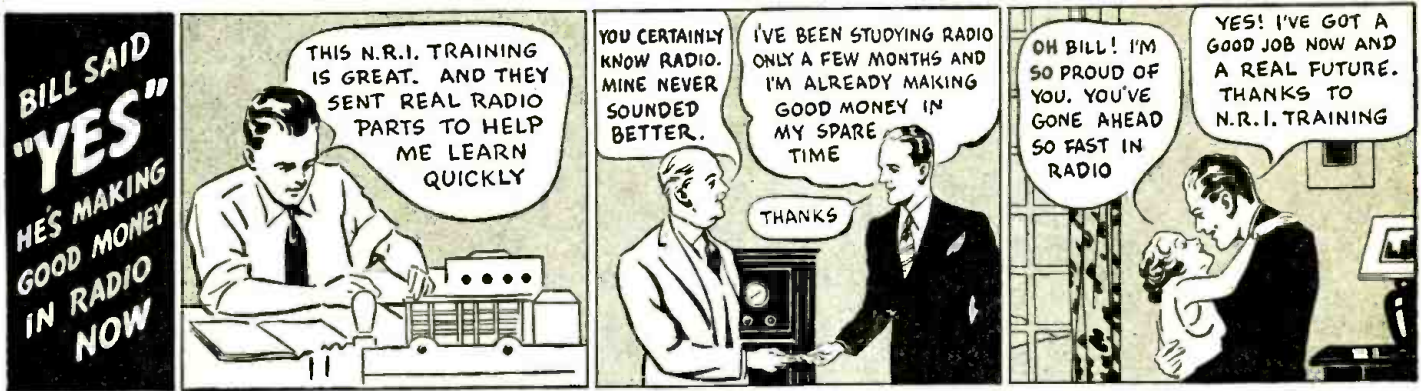

**BILL SAID "YES"** HE'S MAKING GOOD MONEY IN RADIO NOW

THIS N.R.I. TRAINING IS GREAT. AND THEY SENT REAL RADIO PARTS TO HELP ME LEARN QUICKLY

YOU CERTAINLY KNOW RADIO. MINE NEVER SOUNDED BETTER. I'VE BEEN STUDYING RADIO ONLY A FEW MONTHS AND I'M ALREADY MAKING GOOD MONEY IN MY SPARE TIME  
THANKS

OH BILL! I'M SO PROUD OF YOU. YOU'VE GONE AHEAD SO FAST IN RADIO  
YES! I'VE GOT A GOOD JOB NOW AND A REAL FUTURE. THANKS TO N.R.I. TRAINING



**TOM SAID "NO"** HE'S STILL WAITING FOR "LUCK"

BILL'S A SAP TO WASTE HIS TIME STUDYING RADIO AT HOME

SAME OLD GRIND -- SAME SKINNY PAY ENVELOPE -- I'M JUST WHERE I WAS FIVE YEARS AGO

GUESS I'M A FAILURE. LOOKS LIKE I'LL NEVER GET ANYWHERE  
YOU'LL ALWAYS BE A FAILURE, TOM, UNLESS YOU DO SOMETHING ABOUT IT. WISHING AND WAITING WON'T GET YOU ANYWHERE

# I WILL TRAIN YOU AT HOME *in Spare Time* FOR A GOOD RADIO JOB



J. E. SMITH, President National Radio Institute

**Many Radio Experts Make \$30, \$50, \$75 a Week**

Do you want to make more money? Broadcasting stations employ engineers, operators, station managers and pay up to \$5,000 a year. Spare time Radio set servicing pays as much as \$200 to \$500 a year—full time servicing jobs pay as much as \$30, \$50, \$75 a week. Many Radio Experts own their own full time or part time Radio businesses. Radio manufacturers and jobbers employ testers, inspectors, foremen, engineers, servicemen, paying up to \$6,000 a year. Radio operators on ships get good pay and see the world besides. Automobile, police, aviation, commercial Radio, and loud speaker systems offer good opportunities now and for the future. Television promises many good jobs soon. Men I trained at home are holding good jobs in all these branches of Radio.

**Many Make \$5, \$10, \$15 a Week Extra in Spare Time While Learning**

Practically every neighborhood needs a good spare time serviceman. The day you enroll I start sending you Extra Money Job Sheets. They show you how to do Radio repair jobs that

you can cash in on quickly. Throughout your training I send you plans and ideas that have made good spare time money for hundreds of fellows. I send you special equipment which gives you practical Radio experience—shows you how to conduct experiments and build circuits which illustrate important principles used in modern Radio sets.

**Find Out What Radio Offers You**

Mail the coupon now for "Rich Rewards in Radio." It's free to any fellow over 16 years old. It describes Radio's spare time and full time opportunities, also those coming in Television; tells about my training in Radio and Television; shows you actual letters from men I have

trained, telling what they are doing and earning; tells about my Money Back Agreement. MAIL THE COUPON in an envelope, or paste it on a penny postcard—NOW!

J. E. SMITH, President National Radio Institute, Dept. 6HX Washington, D. C.



IT'S NOT TOO LATE. TAKE MY TIP AND MAIL THAT COUPON TO N.R.I. TONIGHT

J. E. SMITH, President Nat. Radio Inst., Dept. 6HX Washington, D. C.

Dear Mr. Smith: Without obligating me, send "Rich Rewards in Radio," which points out the spare time and full time opportunities in Radio and explains your 50-50 method of training men at home in spare time to become Radio Experts. (Please Write Plainly.)

NAME ..... AGE.....  
ADDRESS .....  
CITY ..... STATE..... 14X-1

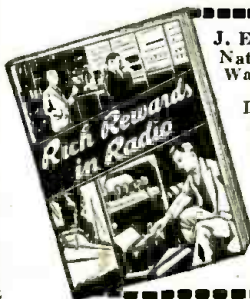

**Get My FREE LESSON on Radio Servicing Tips**

My sample lesson text, "Radio Receiver Troubles—their Cause and Remedy" covers a long list of troubles in A.C., D.C., battery, universal, auto, T.R.F., super-heterodyne, all-wave, and other types of sets, gives you the probable cause and a quick way to locate and remedy these set troubles. A special section is devoted to receiver check-up, alignment, balancing, neutralizing and testing. Get this lesson Free.

**MAIL COUPON NOW**

Please Say That You Saw It in RADIO-CRAFT

# Meet All Radio Servicing Emergencies with GERNSBACK RADIO MANUALS AND SERVICE HANDBOOK

**J**UST as we say—"Be prepared to meet all radio servicing emergencies with the Gernsback Official Radio Service Manuals and Official Radio Service Handibook. You never know when a service job requires that "extra" special attention. It might mean

**Announcing a New Book for Radio Men!**

## Official Radio Service Handibook by J. T. Bernsley



**H**ERE'S the new book on radio servicing that contains everything Service Men must know. The book, **OFFICIAL RADIO SERVICE HANDBOOK**, is edited by J. T. Bernsley, foremost radio service authority. This 1936 service guide is the only book of its kind—its editorial material is so well prepared that the technical information can be understood by even beginners in radio servicing. Every page contains new material, new illustrations—no reprinted literature or rehashed articles.

The **OFFICIAL RADIO SERVICE HANDBOOK** covers thoroughly over 500 radio topics. It tells you how to analyze the latest commercial receiver circuits; how to really make money servicing midget sets; and, how aligning supers can be made easy. It stresses the many uses of different types of test equipment; it gives you short cuts in trouble-shooting and repairing; and, contains over 250 pages of operating notes on 1,000 manufactured receivers. So up-to-date is the **OFFICIAL RADIO SERVICE HANDBOOK**

that it explains thoroughly the features and innovations in the most modern of receivers.

### Partial Contents of This Great Book!

#### PART 1—CIRCUIT THEORY AND ANALYSIS

R.F. Fundamentals; Superheterodyne Receiver Theory; A.V.C. and Tuning Indicator Circuits; A.F. Fundamentals; Power Supply Theory and Circuits; Speakers, Reproducers and Pick-Ups; Commercial Receiver Circuits of All Types, How to Analyze.

#### PART 2—MODERN SERVICING AND TEST EQUIPMENT

Fundamentals of Metering and Test Equipment; Standard Servicing Instruments; The Cathode Ray Oscillograph and Associate Instruments; How to Build Essential Servicing Test Instruments.

#### PART 3—PRACTICAL SHORT-CUTS IN TROUBLE SHOOTING AND REPAIRING

Localizing Trouble by Inspection Methods; Short-Cuts with Test Instruments; How to Quickly and Properly Perform All Types of Repairs; Unusual Servicing Experiences; Tube Troubles and Characteristics.

#### PART 4—SPECIALIZED RECEIVER AND INSTALLATION DATA

All-Wave and High Fidelity Receiver Servicing and Installation Data; Auto Radio Receiver and Installation; Specialized Servicing and Installation (Remote Tuning Controls, Home Recording, Automatic Record Changers, Apartment House Antennae, etc., etc.); Eliminating Noise Interference.

#### PART 5—MODERNIZATION AND CONVERSION DATA

Modernizing and Improving Methods for All Types of Receivers; Converting A.C. Receivers for D.C. Operation and Vice Versa.

#### PART 6—SOCIAL AND ECONOMIC PROBLEMS OF THE SERVICE MAN

Improving Knowledge and Technique; Social Problems—How to Organize, Listing of Servicemen's Organizations; The Future of the Servicing Profession.

#### PART 7—OPERATING NOTES AND PRACTICAL DATA LISTINGS

Operating Notes on Over 1,000 Receivers; I.F. Peaks of Approximately 3,000 Receivers; Voltage Dividers for 300 Receivers; Speaker Field Listing; Radio Mathematics and Measurements.

★ **OVER 250 PAGES OF OPERATING NOTES** ★

**OVER 1,000 PAGES**

**OVER 750 ILLUSTRATIONS**

Beautiful Leatheroid Cover 6 x 9 Inches



*For Car-Radio Servicing—Get These*

### AUTO-RADIO SERVICE MANUALS

#### 1935 Official Auto-Radio Service Manual

Over 240 Pages 9 x 12 Inches  
Over 500 Illustrations  
Flexible, Looseleaf, Leatherette Cover  
**LIST PRICE \$2.50**

#### 1933 Official Auto-Radio Service Manual

Over 240 Pages 9 x 12 Inches  
Over 500 Illustrations  
Flexible, Looseleaf, Leatherette Cover  
**LIST PRICE \$2.50**

**GERNSBACK PUBLICATIONS, Inc.**  
99 Hudson Street New York, N. Y.

the difference between doing the job or losing it. You're safe if you have on hand the **GERNSBACK SERVICE BOOKS**—either for regular service work or for servicing auto radio receivers.

Get your copy today!

## Which of These OFFICIAL RADIO SERVICE MANUALS Do You Need To Complete Your Files?

There's perhaps one or more of these great service manuals which you might need to complete the set. Collectively they represent the largest collection of service data ever compiled. Evidence of their importance to Radio men is shown by the fact that over 80,000 **OFFICIAL RADIO SERVICE MANUALS** have been sold during the past few years. Use the coupon below to order your Manuals.



#### 1935 OFFICIAL RADIO SERVICE MANUAL

Over 1,000 Pages, 9 x 12 Inches Over 3,000 Illustrations  
Flexible, Looseleaf, Leatherette Cover  
**List Price \$7.00**

#### 1934 OFFICIAL RADIO SERVICE MANUAL

Over 400 Pages, 9 x 12 Inches Over 2,000 Illustrations  
Flexible, Looseleaf, Leatherette Cover  
**List Price \$3.50**

#### 1933 OFFICIAL RADIO SERVICE MANUAL

Over 700 Pages, 9 x 12 Inches Over 2,000 Illustrations  
Flexible, Looseleaf, Leatherette Cover  
**List Price \$5.00**

#### 1932 OFFICIAL RADIO SERVICE MANUAL

Over 1,000 Pages, 9 x 12 Inches Over 2,000 Illustrations  
Flexible, Looseleaf, Leatherette Cover  
**List Price \$5.00**

#### 1931 OFFICIAL RADIO SERVICE MANUAL

650 Pages (Including Supplements) 9 x 12 Inches Over 1,500 Illustrations  
Flexible, Looseleaf, Leatherette Cover  
**List Price \$4.50**  
(Including Supplements)

### MAIL COUPON TODAY FOR ANY BOOK!

GERNSBACK PUBLICATIONS, Inc. RC-836  
99 Hudson Street, New York, N. Y.

Enclosed you will find my remittance of \$..... for which please send me promptly, **POSTPAID**, the book indicated below.

- |  |  |
|--|--|
| <input type="checkbox"/> 1935 Edition @ \$7.00 | <b>AUTO-RADIO MANUALS</b>  |
| <input type="checkbox"/> 1934 Edition @ \$3.50 | <input type="checkbox"/> 1935 Edition @ \$2.50                     |
| <input type="checkbox"/> 1933 Edition @ \$5.00 | <input type="checkbox"/> 1933 Edition @ \$2.50                     |
| <input type="checkbox"/> 1932 Edition @ \$5.00 | <input type="checkbox"/> Official Radio Service Handibook @ \$4.00 |
| <input type="checkbox"/> 1931 Edition @ \$4.50 |  |

Name .....

Address .....

City ..... State .....

(Send remittance by check, money order, or registered letter if it contains cash, currency or unused U. S. Postage Stamps.)

### OVERSEAS READERS!

These books can be obtained from the following houses:

#### GREAT BRITAIN

Gerringe's, 9a, Green Street, Leicester Square, London, England

#### FRANCE

Editions Radio, 42 Rue Jacob, Paris

#### AUSTRALIA

McGill's 183-195, 218 Elizabeth St., Melbourne, C. I

Please Say That You Saw It in RADIO-CRAFT



"Takes the Resistance out of Radio"

Editorial Offices: 99 Hudson St., New York, N. Y.

HUGO GERNSBACK, Editor

Vol. VIII, No. 2, Aug. 1936

## TELEVISION PROBLEMS

An Editorial by HUGO GERNSBACK

**I**N MY EDITORIAL entitled, "Is Television Here?", published in the August, 1935, issue of *Radio-Craft*, I stressed the point that television was still in the laboratory stage and was destined to remain so for some little time to come. There has been no change in the art as far as is discerned at this time.

Television is still entirely in the laboratory stage, and a host of problems still must be solved before television as a whole is an accomplished fact. It is true that tremendous activity is going on in television research in the United States, as well as abroad, but it would be rash to predict even today that television is just around the corner.

As far as television *transmitting* is concerned, it can be stated that transmission technique has been fairly well perfected and, if other problems had been solved, television would be an accomplished fact today. In the transmission end of television, cost means relatively little. A transmitter costs anywhere from fifty thousand up to a half-million dollars. This would be a comparatively simple matter because quite a number of stations are ready to transmit almost immediately *if the television receiver problem had been solved*.

We often notice in the daily press and even in the technical press, remarks to the effect that if television came today, the television broadcasters would have practically nothing to transmit. Such a contention is ridiculous. There is plenty to transmit in television even today. Of course, the theatrical and motion picture industry has been in the habit of getting the jitters every time the word television was mentioned because they felt that television would instantly invade the stage and transfer the latter into the home. To us this seems a foolish notion. No advertising sponsor is likely to spend anywhere from fifty to a hundred thousand dollars for an elaborate production of the type of a *Ziegfeld Follies* or other musical comedy, for the simple reason that such a production would only be good for one transmission and a new one would have to be put "in scene" next week.

Instead, the television broadcaster, for the first few years will concern himself with broadcasting simple plays or other actions in the studio; scenes from outdoors such as sports events, political broadcasts; action events such as fires (see front cover of this issue), but most of all the radio audience will wish to see the speakers and singers in the future, because it wishes to meet them face to face. Perhaps this will not always be a happy idea, because some personalities, while they are excellent talkers or singers, may not have physical personalities which match their art. But we may be sure that even here, good make-up and other television tricks will readily fool the television audience.

Television will do marvels when it comes to bringing to your home little-known scenic beauty which can be picked up at home and abroad. Furthermore, can you imagine anything more interesting than taking a personally-conducted tour, via television, through our great industrial establishments? Who would not like to see how automobiles are made, how steel is fabricated, how oil is refined, how shoes are made, and thousands of others? Here is a tremendous field for advertisers, where a real advertising job can be done minus the usual blatant sales talk, simply by letting the customers see for themselves what is going on behind the scenes without trying to sell them anything on the spot.

So much for the transmission end of television. We now come to the crux of the television question and that is the

receiver. I have stated for many years back that as long as a good television receiver cannot be bought by the public for the price of an ordinary radio receiver, television will not be here. There are today over 20 million radio sets in the United States. This has been accomplished by making the price of such a nature that even the most modest home can afford one. For this reason, the television problem will not have been solved until you can buy a good, serviceable, visual receiver anywhere from \$25 upwards.

You cannot imagine dozens or hundreds of television broadcasters *if there are no television receivers to broadcast to!* This is such a simple truism that it is surprising how often it is completely forgotten by the television engineer who blithely goes ahead and thinks of television sets that cost anywhere from \$200 upwards.

I have, in the past, maintained many times that, so far, the true television problem has not been solved. The present mechanical and cathode-ray scanner will not prevail in the future. We must have something totally different—an instrumentality that can be produced in huge quantities at a low price. In producing such a device, the following should always be uppermost in the mind of the television engineer, because, so far, television has remained where it is, simply because these few problems have not been solved.

1. **Light Intensity.** The popular television instrument that will prevail must have great light intensity, so much, in fact, that it will be possible to view the television broadcast at least in a fair amount of daylight. This means high luminosity which so far no television receiver has.

2. **Large Screen.** Any screen less than a foot wide and nearly as high will be unsatisfactory. It should even be larger if possible. If there is enough light intensity, it may be possible to throw an image on the wall of a room, as we now do in home-movie projection, but again the light intensity must be very high to accomplish this, otherwise you must sit in semi-darkness to view the image, (which again will not be satisfactory).

3. **Simplicity of Controls.** The successful televisor must have few controls, certainly not more than three. There will be one knob which will switch on the set; this gives you both sound and sight; as well as the usual volume control. The second control will change the light intensity from soft to brilliant. The third knob as at present will be for tuning. Further controls may make the set unpopular.

4. **Multiple Viewing.** I mentioned several years back that the ordinary, 1-screen television set was impractical; this still is true, and for the following simple reason: *you must move into the "line of sight."* A multiple screen where people from different locations of the room may view a television broadcast is, therefore, necessary.

5. **Price Range.** The only way to popularize television will be to merchandise the product in such a way that the public can buy receivers at a popular price. This means a price range from \$25, upwards. To be sure, the better sets will range all the way up to several thousand dollars, but this will be for millionaires. Ninety-five per cent of the television receivers, however, must be in the popular-price range if television is to assume the importance that oral radio has today. Television engineers and constructors, as well as manufacturers should always bear this in mind, because *the broadcast industry is not likely to invest millions of dollars, and then remain satisfied to broadcast to only a handful of television receivers.*

# THE RADIO MONTH



The plaque commemorating the 10th birthday of the National Broadcasting Co.

## NBC'S TENTH ANNIVERSARY

TEN years ago, in November, 1926, Owen D. Young, chairman of the board of RCA, published an announcement of the formation of the National Broadcasting Co. Mr. Young at that time said: "The purpose of the company (NBC) will be to provide the best programs available for broadcasting in the United States." In other words, the NBC was founded on a non-profit basis.

Last month, the NBC displayed for the first time the plaque commemorating its 10th birthday—but it is not the old NBC which made this display. The NBC of today, with its new high-power president—Lohr—has entered a new phase of its development. It is no longer the non-profit organization of 1926—but rather, a hard-boiled, two-fisted selling organization which is out to make 1936 radio's first \$100,000,000 year with NBC and RCA reaping a good deal more than a "lamb's share."

## G.M. BUYS CROSLY RADIO PLANT

LAST month, with the announcement of the purchase of the Kokomo plant of the Crosley Radio Corp. the General Motors Corp. entered, for the second time in its history, the business of making radio sets.

It will be remembered that some 4 years ago General Motors made a line of household radio receivers and although the sets were thoroughly reliable and well engineered, the company received a severe financial beating as a result of this business flyer.

This time, however, they are proceeding with greater caution—as they will manufacture only automobile radio receivers for use in their cars. The new manufacturing venture will be known as the Delco Radio Division and will be a Delco-Remy Corp. subsidiary.

## A.R.R.L. PICKS A NEW PRESIDENT

LAST month, the American Radio Relay League selected the second president that the organization has had since it was founded in 1914 by the late Hiram Percy Maxim. The League members would have no other president but consistently appointed Mr. Maxim, up to the time of his death, in February of this year.

The name of the second president is Dr. Eugene C. Woodruff, head of the electrical and radio engineering department of Pennsylvania State College. He is well known as an inventor and as an instructor in electrical engineering and radio. But perhaps, he is more widely famed in radio amateur circles for his "bag of tricks"—a battered old suitcase carried to every amateur gathering. From his "bag of tricks" he produces gadgets and new ideas that never fail to excite the admiration of all present.

President Woodruff automatically assumes a similar position in the International Amateur Radio Union—a federation of 26 national amateur societies.

## SOUND MOVIES IN CRIME DETECTION

A NEW tie-up between radio, or rather electronic devices and the police was announced jointly, last month, by RCA Photophone and the New Jersey State Police.

The new system consists of a sound-film recorder made in the most simple possible manner, so that Police Officers can operate it without difficulty. This is used to record the characteristics of speech and mannerisms in action of criminals. Reproductions of the sound film are then sent to police departments all over the country where they are stored.

In this way, the police, throughout the entire country have an imperishable record of the police "line-up" which has proven so effective in the identification of criminals.

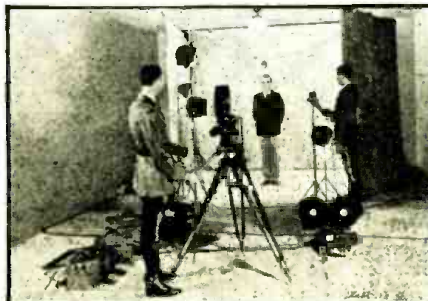

A typical set-up of sound equipment for recording criminals' motions and voices.

## JAPAN CONDUCTS TELEVISION TESTS

IN KEEPING with the television activity going on throughout the world, Japan has instituted a visual broadcasting research department of its own. Last month, the Japanese Government, through the Broadcasting Corp. of Japan, granted a subsidy of 300,000 yen for television development during the fiscal year beginning Apr. 1, 1936.

This amount, it is understood, will be used mainly for the construction of a powerful transmitter to broadcast the images, using the system developed by Dr. K. Takayanagi of the Hamamatsu Polytechnical College. Dr. Takayanagi has been working with a nipkow disc method of scanning and his aim has been to reduce the number of lines to a minimum to reduce the cost of transmitting and receiving apparatus. He has been using a 40-line scanning system with a cathode-ray tube in the image receiver.

Dr. Takayanagi says: "The major problem now is to get responsible firms interested in making receiving sets so that they will be within range of the public." Sets of the type he has designed should be manufactured to sell for 700 yen per set, he feels.

## THE RADIO TALKING MIRROR

A NEW device that uses a mirror to lure the ladies and then delivers a sales talk to them was placed on the market, last month, by an enterprising inventor.

It is well known that chewing gum machines, weighing scales, etc., are provided with mirrors because of the attraction of the mirror for both men and women. This device uses a capacity-controlled vacuum-tube relay, a phonograph reproducer and amplifier, and a timing device to turn off the advertising patter.



When you step up to this mirror to fix your tie, it talks back to you.



# IN REVIEW

Radio is now such a vast and diversified art it becomes necessary to make a general survey of important monthly developments. RADIO-CRAFT analyzes these developments and presents a review of those items which interest all.

## NBC LOSES "AUNT JEMIMA" SUIT

A PHONOGRAPH reproducer and amplifier cost the NBC and several of its advertising sponsors the sum of \$115,000, last month, in the court decision of the suit between Miss Tess Gardella—the "Aunt Jemima" of stage and radio—and the NBC, General Foods, Inc. and Log Cabin Products, Inc.

Miss Gardella charged that other entertainers had been hired to broadcast her songs and use her name in programs over the NBC network. The jury reached its decision after listening to phonograph records sung by Miss Gardella and then by her imitators.

This is another instance in which instantaneous recordings of radio programs have proven of great value.

## RADIO DRAMA IN ETHIOPIA

A MOST unusual radio hook-up was completed early last month in far-off Addis Ababa, when that city fell before the advancing Italian motorized army corps.

In the plundering which followed the evacuation of the Ethiopian forces, the American Legation was in considerable danger of being attacked by the savage marauders. The American minister, Cornelius Van H. Engert, kept the U.S. State Department informed as to the course of events. As conditions became worse an attempt was made to reach the British Minister in Ethiopia, by radio.

When this failed, due to a difference in the frequencies used by the two stations, the U.S. legation notified a Naval station in the U.S. to contact the British Ministry at Addis Ababa, via London.

Thus it was necessary to send a message 12,000 miles before help could be obtained from 4 miles away!

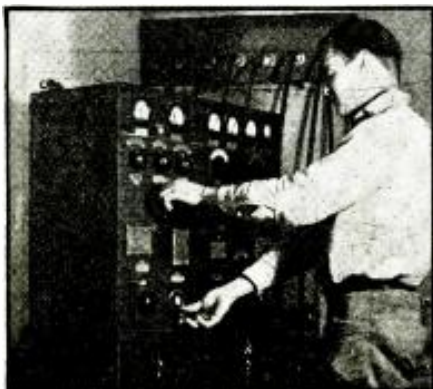

The short-wave station of the American Legation at Addis Ababa—and an operator.

## NEWSPAPER RADIO ACTIVITIES

NEWSPAPERS only a short time ago considered radio broadcasting as a serious rival—but within the past month a drastic change has taken place in the situation.

William Randolph Hearst, who several months ago ordered the removal of radio programs and radio columnists, comments from all his papers changed his mind, last month, and ordered the radio material to be restored. He also made a play to buy radio stations in a number of cities—apparently with the idea that if he could not remove the menace, he could at least, control it.

And another large newspaper interest, the Scripps-Howard chain has announced that they would rival Hearst in the broadcasting field just as they do in the paper line. Scripps-Howard operates 2 stations and has applied for licenses for 2 more; Hearst owns 8 stations and has applied for 2 more licenses.

## RADIO PROTEST IN HOLLAND

IT IS expensive to own a broadcast receiver in Holland, due to the high licensing fees charged by the radio stations which are government owned.

For this reason, groups have formed in which one member owns a radio set of 5 or more tubes that is able to tune in any of the European stations. He pays the expensive dues and the other members of the group have only a loudspeaker which is connected to the set by means of wires.

This makes it possible for the poor people to enjoy the broadcasts without having their own set. The owners of the radio receivers charge the loudspeaker customers 250 Guilden a month (about \$1.00) but last month, large groups of the loudspeaker users started protest meetings and are refusing to pay the fee which they say is excessive. They even painted signs on the pavements telling of their plight!



The protests against excess radio costs were even painted on the street pavements.



The clever way in which roller skaters defied the Toledo, Ohio, police.

## SKATERS OUTWIT POLICE WITH RADIO

HERE'S how five youngsters were observed circumventing a police ordinance against roller-skating in the streets of Toledo, Ohio, last month.

While four skated to their hearts' content—though with a weather eye out for the cop on the beat—the fifth stayed on the sidewalk with a crystal radio receiver tuned to the local police radio station.

It was this radio look-out's job to keep his phones clamped on his head; if he heard a police call to "investigate boys skating in street" he would blow a whistle and by the time the scout car arrived, the boys would be skating lawfully on the sidewalk. Quite a novel use for a crystal set, is it not?

## RADIO HAPPENINGS IN EUROPE

WITHIN the past month a number of things of interest to radio men, have happened in Europe. These are mentioned briefly below.

England has now increased the force of "Queen Bee" planes which are robot operated and fly without any pilot aboard, from a single experimental ship to a large fleet. These planes which were described some months ago in *Radio-Craft*, can take off, fly over 100 miles per hour, reach an altitude of over 10,000 feet and land without any human being on board.

King Edward VIII took possession of his new Canadian-built, radio-equipped car, last month. This car has a very complete radio receiver, of the all-wave type installed.

Radio station EAJ7 was fined \$30 it was announced last month, for devoting too much time to advertising (too bad

*(Continued on page 109)*

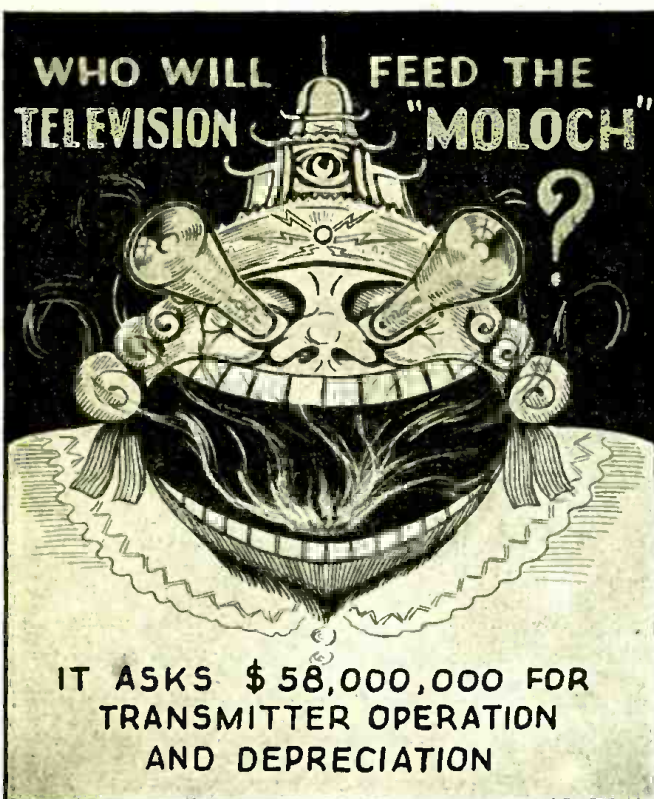

Fig. 4. The RCA estimate of television yearly cost.

**S**ENSATIONAL reports published in newspapers that television is ripe for practical utilization, and that in a short time to come it will be introduced into the home, have aroused hope among optimistic radio listeners that this technical dream finally has become a reality. The pessimists however, in reading between the lines fail to envision such fast progress.

If we wish to find the reason why these pessimists—and there are many of them among leading radio engineers—have this negative opinion about an early achievement of television, we should remember that television can not really be considered as just a supplementary art to sound broadcast, but rather as an ardent competitor, subject

**80 TELEVISION TRANSMITTING STATIONS NECESSARY**

All of us know, that, at least at present, ultra-short waves are the only means by which television images of better quality can be radiated. However, since the effective range of ultra-short waves is very small, it is necessary to employ a large number of transmitters if most of the country is to be covered with television service.

According to estimates made by RCA Mfg. Co., 80 ultra-short wave stations will be necessary to give television a distribution equal to that of broadcasting. This firm (which should know best the cost of a suitable television station) has quoted its price for one station as approximately \$500,000, which brings the total sum required to install a television network consisting of 80 such transmitters up to \$40,000,000—or \$500,000 per station. As RCA further stated, an additional \$40,000,000, must be spent for an interconnecting network consisting of the

newly developed coaxial cables, since normal telephone lines cannot be used for this purpose. The initial investment cost, in case television is to be introduced on a nation-wide scale, is, therefore, about \$80,000,000 (see Fig. 1).

Despite the fact that \$80,000,000 does not seem much money on paper—especially when it is remembered that such large-scale investments are fairly normal transactions among “big-money people”—one should keep in mind that in the realm of radio entertainment it is a tremendous amount of money since all 600 American broadcast stations together have an estimated value of only about \$60,000,000, and this sum includes even the good-will! (See, “Milestones in Broadcasting—Part II,” *Radio-Craft*, February, 1936.)

**THE PHILADELPHIA PLAN**

A well-known Philadelphia group, not financially interested in present radio networks and probably not much interested in the manufacture of sound broadcast receivers, recently permitted some reports to “leak out,” the gist of which are as follows: This group intends to erect in the beginning a television network of 10 stations, so located as to cover the principal centers of population. Among the cities selected are Boston, Los Angeles, New York, Philadelphia, Portland and San Francisco, etc. This network it is claimed would cover 40 to 50 per cent of the population of the country. Each station has been estimated to involve an outlay of about \$250,000, which brings the total cost for the entire group of 10 stations to about \$2,500,000.

<p>600 AMERICAN BROADCAST STATIONS (100% NATION-WIDE COVERAGE)</p> <p>VALUE INCLUDING GOOD WILL \$60,000,000</p>	<p>80 TELEVISION STATIONS ABOUT (80 TO 100% NATION-WIDE COVERAGE)</p> <p>IMAGE</p> <p>SOUND</p> <p>INITIAL INSTALLMENT \$80,000,000 INCLUDING CO-AXIAL CABLE NET WORK</p>	<p>10 TELEVISION STATIONS IN KEY CITIES (40-50% NATION-WIDE COVERAGE)</p> <p>IMAGE</p> <p>SOUND</p> <p>INITIAL INVESTMENT \$2,500,000 WITHOUT INTER-CONNECTING CABLE NETWORK</p>
--	---	--

Fig. 1. Television compared with sound broadcasting.

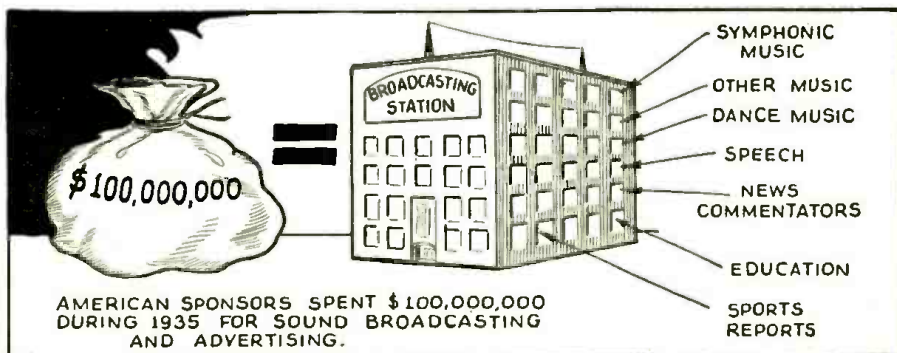

Fig. 2. The cost of sound entertainment to advertising sponsors at the present time.

# WHAT ABOUT TELEVISION?

Here is a glance behind the curtain which hides practical television from our view—after reading this lucid explanation every reader of *RADIO-CRAFT* will understand why television has not "arrived".

W. E. SCHRAGE

to entirely different technical and financial conditions; and since money is the nourishing mother of all technical progress let's not only consider the technical problems of television, but also the financial complications which are involved in this interesting means of communication.

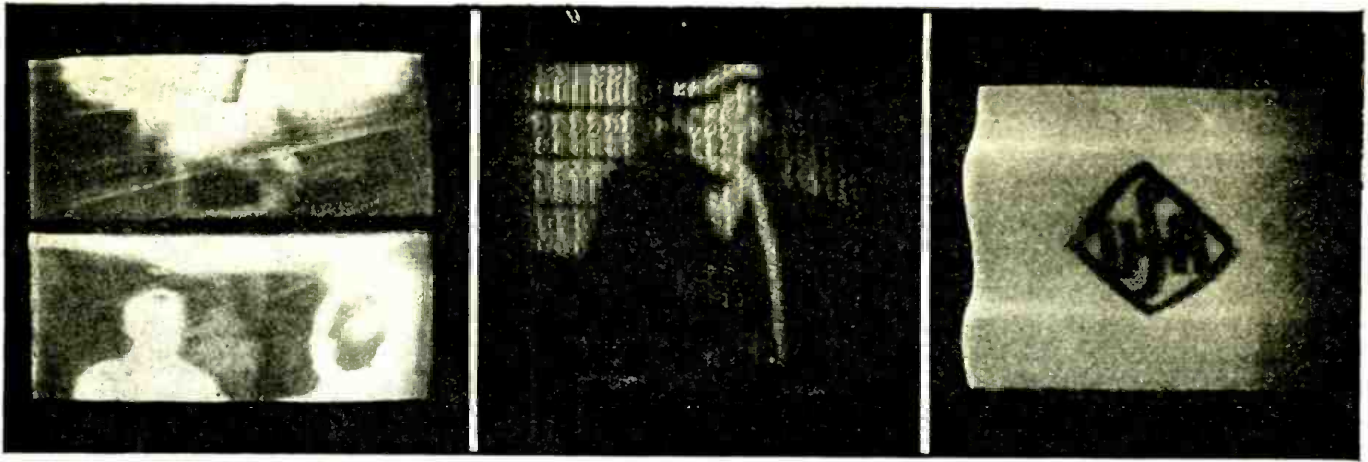

Fig. A. Incorrect television receiver adjustments. Left, the frame (horizontal deflection) has been incorrectly adjusted; center, when the receiver oscillator is off adjustment, cutting off one side of the signal. Right, a 60-cycle voltage interfering with the images.

### THE AIM OF BOTH PARTIES

This large variance in estimated price for a *single station* (or  $\frac{1}{4}$ -million vs.  $\frac{1}{2}$ -million dollars) is a valuable key in understanding what goes on behind the curtain of television politics. There are, then, two outstanding groups that plan to put "big money" into television.

One group, bearing in mind (a) its respectable income from licenses to receiver factories; and (b) its large investments in broadcasting networks, does not dare to make hasty experiments which would endanger these sources of income. They consider also the important fact that in case regular television broadcasting should start in one single city only, the sale of sound broadcast receivers all over the country would be instantly paralyzed. The second group however is interested in television broadcasting *only*, and desires early financial returns from their investments in preliminary experiments, regardless of how much other branches of the industry must suffer.

However, both projects are at present no more than "projects" and 10 times as many reports full of alarming news "leaking out" from Philadelphia will not accelerate the first group into taking any premature steps since they know very well that television receivers because of retail prices being too high at present have no large-scale market. Another important point in their calculation is the fact that without a large-scale distribution of television receivers the project of television broadcasting is doomed to failure.

### THE \$400 RECEIVER

If we look at the following facts we will easily see that there must be a delay until television receivers are more reasonable in price. On January

1, 1936, there were, in the U. S. 22,869,000 families operating one, or more than one, radio receiver in each home. In addition, 3,000,000 auto-radio receivers are at present in use, which brings the number of "radio-outlets" to about 25,000,000.

To feed these 25,000,000 "outlets" with proper entertainment, American advertising sponsors have spent during 1935 approximately \$100,000,000, or in other words \$4.00 per "outlet" (see Figs. 2 and 3).

Since the average price of a modern television receiver is at present \$400 (starting with \$300 and varying up to \$800), it is difficult to imagine that more than 100,000 television receivers will be in use in the first 3 years. This is a very important factor worthwhile keeping in mind, as we shall see.

We know by RCA estimates that in case a nationwide network of 80 television stations is to be operated it will cost \$58,000,000 a year for transmitter operation and depreciation (see Fig. 4). Expressed in the shrewd language of the balance sheet this expenditure asks for a gross revenue of about \$100,000,000 or a gift of \$1,000 to each owner of a television receiver by the sponsors!

### A RIDICULOUS PROPOSITION

To believe that radio sponsors will

spend this tremendous amount of money is ridiculous. But let's be generous, and double the estimated number of television receivers in use during the first 3 years (at a price per receiver of \$400). This would bring the total up to 200,000 television sets. In addition to this "boosting" we shall cut the quite liberal estimated sum of transmitter operation cost, etc., and also the required gross revenue in half; which would bring us down to a sum of about \$50,000,000.

However, once again, the balance sheet would indicate the impossibility of such a beginning, because television sponsors will have to make a donation of about \$250 for each television receiver in operation, which leads us again into the dark. Much more favorable financial conditions are possible under the "Philadelphia Plan," which proposes the initial installation of only 10 stations, to be erected in important key-cities. This plan it is claimed, provides a coverage of about 40 to 50 per cent of our population. Transmitter operation, depreciation, etc., for such a small network would take approximately \$2,000,000, but still the production cost of the program would ask for an expenditure by the sponsors of about \$30,000,000, if the television program is

(Continued on page 102)

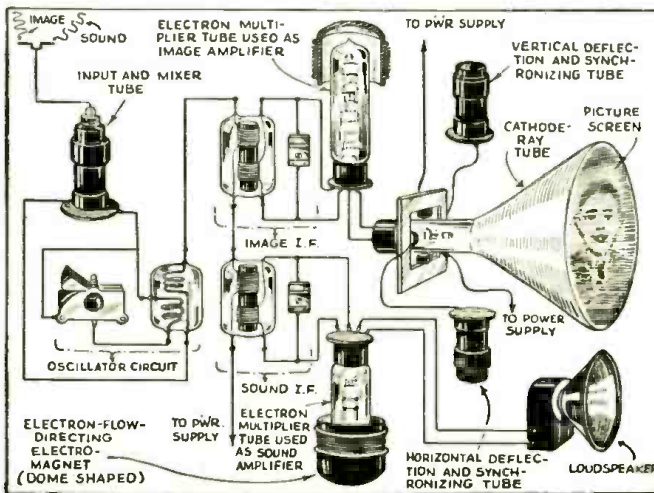
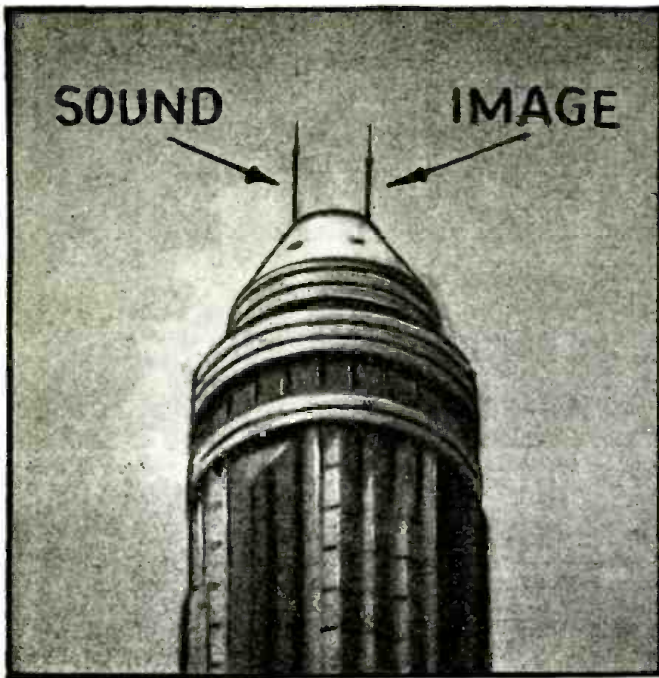

Fig. 5. A television receiver of the future. Electron multiplier tubes are employed. There are only 5 tubes in the complete receiver!



Fig. 3. Cost of radio entertainment, per set.



(Radio-Craft)  
Television antenna system atop the Empire State Building, in New York City. The height thus attained, 1,250 ft., affords an estimated television range of about 40 miles. This photo, made by means of a camera equipped with a special telephoto lens, was taken especially for RADIO-CRAFT. Note that these antennas are continually being changed as new ideas are tried—at "W2XF."

*Jerry—Yes, television is advancing by leaps and bounds. We may have it before another year.*

*Angeline—How nice! I have always wanted to see what static looks like.*

Permission—The Pathfinder

**S**KELETONS in the television family closet, we are inclined to believe, induced Angeline—the heroine in the *bon mot* that serves as a prolog to this story—to unconsciously disparage television.

One such skeleton is the Nipkow disc, to which practically all writers allude before they've concluded a television article. Unfortunately, the Nipkow disc in time did manage to earn for itself a rather unsavory reputation for poor image fidelity (among other characteristics), that like a bad name has hung on despite the fact that modern mechanical systems bear little resemblance to the parent development! Early Nipkow devices were large, unwieldy things. Ranging in size from 2 to 4 ft. in diameter, they shivered and shook, as they whirled at speeds which seemed to augur decapitation for anyone venturing into the same room with the

# NEW DEVELOPMENTS IN TELEVISION

Will we have television in 1937? Just what are some of the technical obstacles confronting the technician? The author presents a few of these questions—and their answers.

R. D. WASHBURNE

contraption! Today, you find mechanical systems incorporating units, functioning on the Nipkow principle, that fit into the palm of the hand; and the moving parts are so well coordinated that their vibration is hardly perceptible. The "static" (flecks and streaks of light, etc.) we learned to expect in the early days as being an accepted evil where the Nipkow principle was involved, is a thing of the past; your modern image (either transmitted or reproduced by any one of several mechanical systems) is almost free of the transient phenomena that so effectively marred earlier performances.

Another skeleton concerns the cathode-ray system of television. Is "peasoup"—green the only color in which we may expect to view images produced by means of a cathode-ray tube?; what about black-and-white, or even color images? Is it possible to secure images as big as, let us say, the cover of *Radio-Craft* magazine? Will it always be necessary to look at the end of the tube; or is it possible that the image could be projected to points beyond the end of the tube? Are these tubes expensive—fragile—short-lived?

Most of the answers to these questions—and many more on the same topic—have appeared either in past issues of *Radio-Craft* or in the current issue, but we will reproduce them here in condensed form. The greenish tinge is preferred because it is the least expensive fluorescent powder, and because it produces the greatest optical effect with the least amount of power-supply and signal-input energy. But a black-and-white image is yours for the asking, if the factors above mentioned are excepted. Color television, too, is available—but the technical problems at this point become highly involved (see Allen B. DuMont's article on the subject, in August 1935 *Radio-Craft*).

The matter of size appears to be a moot subject in connection with cathode-ray equipment; and this again brings up the topic of image projection. To this observer it appears that 3 families of investigators are evolving—one leaning toward larger and larger tubes for either direct- or reflected-image reception; a second toward smaller and smaller tubes of proportionately greater brilliancy, for projected-image reception; and a third or "centralist" group, best represented by RCA, which adheres to the middle path between the preceding two, by offering a moderately bright, reflected image measuring about 5 x 7 inches.

Whether any of these tubes will be expensive, fragile, or short-lived, appears at the present writing to be almost entirely contingent upon the cognition of the equipment owner—if he understands the apparatus, and manipulates it accordingly, the cathode-ray tubes will be found to be *relatively* inexpensive, sturdy and long-lived; but if

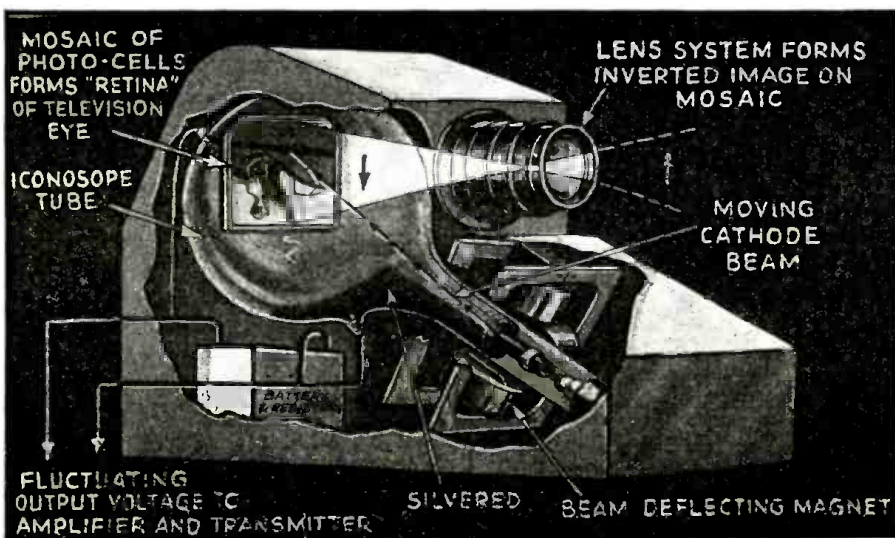

A phantom view of the Zworykin "Iconoscope" or cathode-ray camera for television image pick-up, indoors or out. The "mosaic" is an area of millions of tiny photo-cells that form a "retina" upon which is focused the image of the subject being televised. The moving cathode beam discharges all these photo-cells, successively, as the screen or "retina" is scanned. The resulting discharge voltage fluctuation is then fed to the output circuit (transmitting equipment, etc.).

they are used without due regard for certain fundamental considerations, then the reverse may be true. In time, ways and means will be found to reduce this human element to a minimum. Continued investigation of the cathode-ray tube is enabling the transmitting and receiving technician to iron out all those little quirks that formerly served as sources of distorted, erratic image reception. A blanket indictment of "static" is no longer considered to close the case, when mal-performance is encountered. Instead, faulty image reproduction is the signal for all manner of test equipment to be put into operation, until the real cause of the trouble is definitely cataloged.

Still a third set of bones that has contributed to an apathetic condition on the part of Mr. (and Mrs.) John Q. Public has been his own lack of imagination. Having sated his appetite on a diet of Mickey Mouse films and cabalistic symbols, for the past 5 years, he has ceased to realize even remotely the possibilities of the art so clearly outlined in this month's editorial. Perhaps it is easier, now, to comprehend sister Angeline's relief at the thought of being able to "see what static looks like."

Let us now leave Angeline and Jerry to their uncertain ideas about television, and look into the whys and wherefores of the items that made the newspaper headlines shown at upper-right, pg. 75.

These headings refer to plans by NBC-RCA to develop a commercially practicable television system by perhaps Fall, 1937. Part of the promise held forth in the *New York Times* item of last year, was fulfilled last month when, as the lower group of newspaper headings indicate, RCA demonstrated experimental television transmission and reception on 6 to 7 meters, narrowcast ("beamed" or directed) between two points about a mile apart, at Camden, N. J.

The performance of the 30-W. beamed output of W3XEP, the transmitter used in sending to the single receiving point, was said to be approximately equivalent to that which may be expected from W2XF, the recently-constructed 10-kw. ultra-short wave audio-visual (television) broadcast transmitter perched a quarter-mile in the air, atop the Empire State Building in mid-Manhattan, New York City; experimental operation of W2XF on the scheduled opening day, June 29th, will inaugurate the field tests forecast in the remaining portion of last year's *Times* item.

(Continued on page 120)



(Pictures, Inc.)

An amazing sequence of operations is here illustrated in this untouched photograph. The original, as a 6 x 8 in., 240-line (24-frame) image, appeared on the end of a cathode-ray tube in the television laboratories of Philo T. Farnsworth. It was then sent over the nation-wide network of the Associated Press Wirephoto Service.

## SKY TO BE THE LABORATORY

Television Images Will Leap From Aerial Atop Skyscraper—  
Field Tests Expected to Spur Progress

By ORRIN E. DUNLAP JR. than five years in which to care. They flash to the Heavies sur-

Above is reproduced a NEW YORK TIMES television news heading, May 12, 1935.



One year later—New York newspaper headings of April 25, 1936!

### TELEVISION STATIONS IN THE UNITED STATES (Experimental Visual Broadcasting Stations)

—Corrected by the Federal Communications Commission,  
May 1, 1936—

Call Letters	Power (Watts)	Company	Location
W2NDR	500 & 1000	Radio Pictures, Inc.	Long Island City, N.Y.
W8XAN	100	Sparks-Withington Co.	Jackson, Mich.
W9XK	50 & 100	University of Iowa	Iowa City, Iowa.
W9XAK	125	Kansas St Col Agr & Apl Sc	Manhattan, Kansas.
W3XAK	5000	Natl. Broadcasting Co. Inc.	Portable
W9XAP	2500	Natl. Broadcasting Co. Inc.	Chicago, Ill.
W2NBS	5000	Natl. Broadcasting Co. Inc.	Bellmore, N.Y.
W9XAL	500 & 150	First Natl. Television, Inc.	Kansas City, Mo.
W9XG	1500	Purdue University	W. Lafayette, Ind.
W2XAB	500	Atlantic Broadc'ing Corp.	New York, N.Y.
W2XAX	50	42,000-56,000, 60,000-86,000 Kc.	
W6XAO	150	Atlantic Broadc'ing Corp.	New York, N.Y.
W9XAL	150 & 500	Don Lee Broadcasting System.	Los Angeles, Calif.
W1XG	500	First Natl. Television, Inc.	Kansas City, Mo.
W9ND	500	General Television Corp.	Boston, Mass.
W2NBT	750	The Journal Company	Milwaukee, Wis.
W2XF	5000*	Natl. Broadc'ing Co. Inc.	Portable
W3XE	1500	Natl. Broadc'ing Co. Inc.	New York, N.Y.
W3XAD	500	Philco Radio & Telev. Corp.	Philadelphia, Pa.
W3XEP	30000	RCA Man'fact'ring Co. Inc.	Portable
W10XX	50	RCA Man'fact'ring Co. Inc.	Camden, N.J.
W2XDR	1000 & 500	RCA Man'fact'ring Co. Inc.	Portable-Mobile
W8XAN	100	Radio Pictures, Inc.	Long Island City, N.Y.
W9XK	100	Sparks-Withington Co.	Jackson, Mich.
W9XAT	500	University of Iowa	Iowa City, Iowa.
		Dr. George W. Young	Portable

\*Construction Permit for 12 kw. power.

Pending Application:

National Television Corp., C.P. for 2000-2100 kc., 500 W.

### DISCONTINUED TELEVISION STATIONS (Experimental Visual Licenses and Permits Discontinued or Expired)

Call Letters	Company	Call Letters	Company
W9XAA	*Chicago Fed. of Labor	W1XAY	Lexington Air Stations
W2XCD	DeForest Radio Co.	W1XY	Pilot Laboratories, Inc.
W10XG	*DeForest Radio Co.	W2XBW	Radio Corp. of America
W6XS	Don Lee B'casting Co.	W2XCO	*Radio Corp. of America
W2XCP	*Freed-Eisemann Radio Corp.	W1XG	Shortwave & Telev. Corp.
W2XCW	General Electric Co.	W1XAV	Shortwave & Telev. Corp.
W9XR	Great Lakes B'casting Co.	W2XBU	Smith, Harold E.
W3XC	*Jenkins Laboratories, Inc.	W2XBO	*United Research Corp.
W3XK	Jenkins Laboratories, Inc.	W1XAE	Westinghouse Elec. & Mfg. Co.
W10XU	Jenkins Laboratories, Inc.	W8XAV	Westinghouse Elec. & Mfg. Co.
W2XAP	Jenkins Television Corp.	W2XBA	WAAM, Incorporated
W2XCR	Jenkins Television Corp.	W8XL	*WGAR, Bro'dcasting Co.
W2XDS	*Jenkins Television Corp.	W8XF	*WJR, Goodwill Sta. Inc.
W7XAO	Jerman, Wilbur		

\*C.P. only.

†Now licensed as Exp. Relay B/C station.

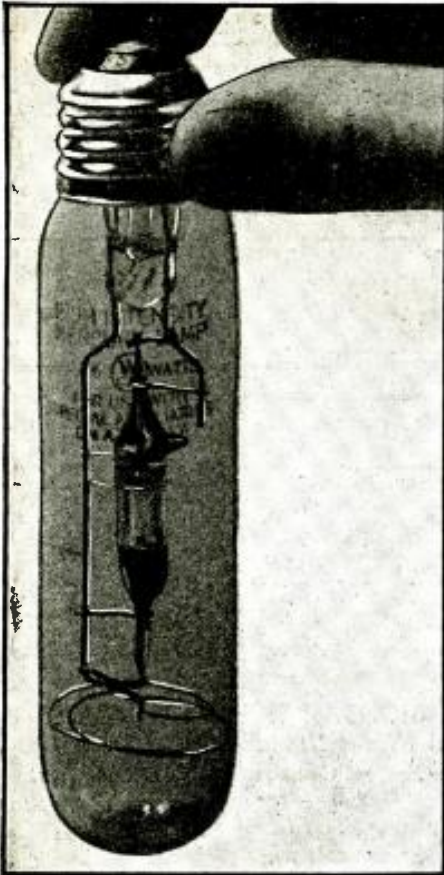

New Westinghouse 85-W. mercury lamp which produces as much light as a conventional 200-W. incandescent lamp (released June 1st, 1936) the newest contribution to television. (Special to Radio-Craft.)

## HIGH INTENSITY ILLUMINANTS IN TELEVISION

Exclusive description (by the "Father of Radio") on new lamps; one is shown here for the first time in any magazine.

DR. LEE DE FOREST

**A**SSUMING that actual television will be brought into the home not by means of the cathode-beam tube as we now know it but by means of one or more mechanical scanning methods, one of the main problems becomes that of a suitable high-intensity light source.

There are two classes of such, one where the light source itself is modulated at television frequencies and the other where the light source is of fixed intensity and modulated by a Kerr cell or other practical inertialess light valve. From the first division, the arc lamp may be excluded on account of its inconstancy. High-intensity tungsten point lights of the incandescent-filament type may be developed but because of the extreme brilliancy at which it is

necessary to burn such filaments their life is apt to be too brief to meet the requirements of home television.

Much was expected from the tungsten ball "point-o-lite" arc as made by the Ediswan Co. of London and possibly if this source could be placed in a sufficiently small bulb to meet obvious optical requirements, such a light source might prove satisfactory.

Most promising in its division now appears to be the high-intensity, high-pressure quartz capillary mercury vapor lamp on which Philips Company of Holland has been at work for some years. In this country the General Electric and Westinghouse Cos. are each developing this type of high-pressure mercury vapor lamp with every promise that this

(Continued on page 105)

## TELEVISION ON THE WEST COAST

In this article, exclusive to RADIO-CRAFT, the author describes early experimental image transmissions from an airplane. The transmission characteristics of W6XAO are described, and illustrated by block diagram. The author also gives construction data for a 5-meter receiver suitable for preliminary experimental reception of W6XAO's images.

DON LEE



One of the Don Lee cathode-ray receiving sets. (A reproduction of the W6XAO transmitter and its cathode-ray image monitor appears in the continuation of this article.)

**T**ELEVISION station W6XAO operates on the ultra-high frequency of 45,000 kc., which corresponds to a wavelength of about  $6 \frac{2}{3}$  meters, with a power of 150 W.

Television activities of the Don Lee Broadcasting System began 6 years ago. By November 23, 1931, the ultra-high frequency television transmitter, W6XAO, was on the air. It has since observed a regular schedule, programs being broadcast at present for varying periods starting at 6:30 o'clock, nightly except Sunday, and at 9 o'clock in the morning, Mondays and Wednesdays.

During its several years of operation, W6XAO has broadcast many unusual programs.

### TELEVISION FROM AN AIRPLANE

On May 21, 1932, in an airplane high above the streets of Los Angeles, Calif., the first television motion picture ever received in the air was successfully reproduced. This feat, which created unusual interest at the time, was made possible through the use of a cathode-ray receiver designed by Harry R. Lubeke,

(Continued on page 110)

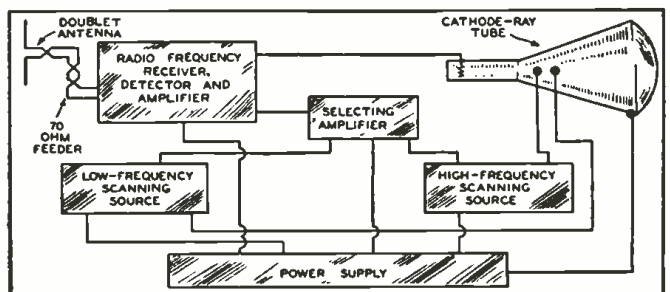

Block diagram of the Don Lee television receiver.

# RADIO PICTORIAL

Radio Entertainment on a Streamline Train; Time by Automatic Voice; A "Silent" Thunder Machine; A German Commercial "See-Speech" Television-Telephone, 125 Miles Long!

**RADIO-EQUIPPED STREAMLINER.** The newest streamline train is this "Green Diamond" of the Illinois Central. The train is to be used on the run between Chicago and St. Louis, and is equipped with a G.E. 12-tube receiver for entertainment of passengers. The receiver is located at one end of the car; one of two wall speakers is seen at left of set.

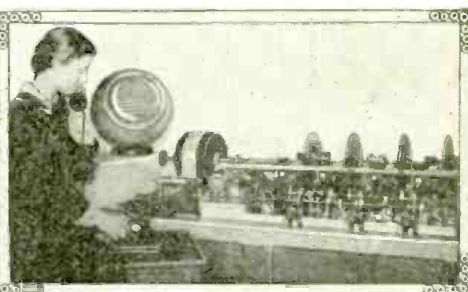
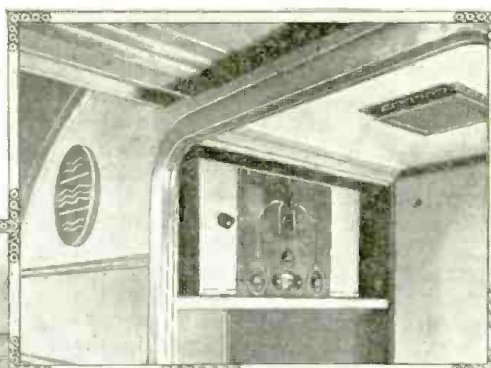

**TELEPHONE TALKING CLOCK.** Londoners who wish to know the time simply dial T-I-M and are immediately connected with the machine

shown at the upper-right, which gives the time in a mechanical voice. Seated beside the apparatus is Miss Ethel Cain, whose voice was used to make the disc records, 4 of which may be seen at the right of the picture.



**THUNDER MAKER.** Ray Kelly, sound effects man of NBC, is shown with a thunder machine he perfected. It is a door-screen, which is struck with a soft hammer. The sound, too weak to be heard in the studio, is picked up by a microphone, and amplified.

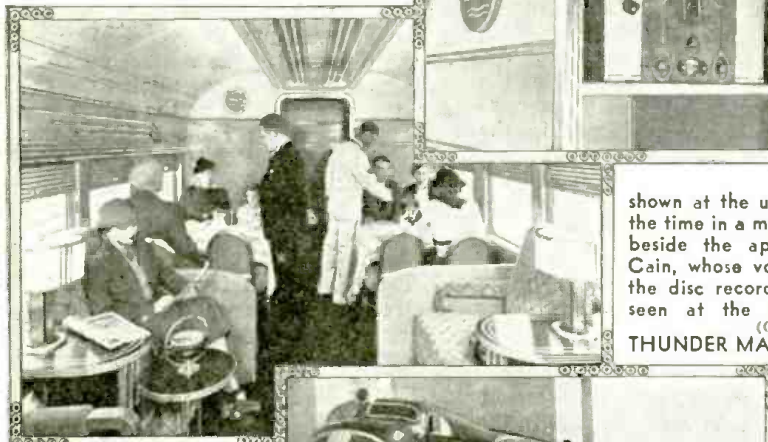

Speakers of the radio system with individual volume controls are located at front and rear of each chair and lounge room, 3 of the 5 cars of the train having been so equipped.

(Foto-News)

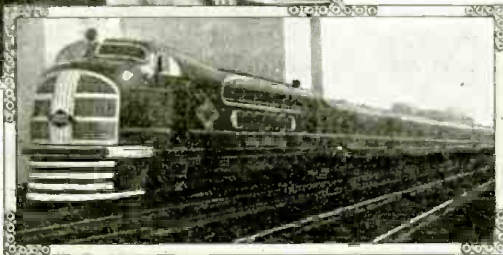

**SEE-SPEECH TELEPHONE LINE.** An often-voiced wish to see the person at the other end of a telephone line has now come true following the perfection of a commercial line between Berlin and Leipzig, Germany, a distance of about 125 miles. The photo shows the interior of one of the booths, where the customer sits in an easy chair, and converses with his friend, while the image of the latter appears on the screen directly before him. Infra-red ray lamps in the shielded cases furnish the necessary light, which does not bother the subject as it is invisible to the human eye. The images are about 8 ins. square, and are said to be very lifelike. The telephone operators who control the circuits have devices in front of them which show how both parties appear. This is necessary as they must see the customers in order to control the clearness of the images. If one of the customers moves out of range or focus, the operators advise him of this through loudspeakers installed in the booths. It is anticipated that when the public becomes accustomed to the system the visual supervision will not be needed and will then be furnished only at extra charge. The scanning is 180 lines and 25 frames per second, and the transmission of the visual signal is by means of the so-called "coaxial cable". This consists essentially of a copper conductor mounted inside of a copper tube, both the tube and the inner conductor being used in the circuit. The use of this new circuit is at present quite expensive, since this type of call now costs around 20 times as much as the ordinary telephone long-distance call. It is expected that the cost will go down rapidly as the system becomes more widely used and the public begins to appreciate the advantages of the service.

What the monitor operator sees when a conversation is under way. Images of both parties appear on her control board and can be continuously checked for best reproduction.

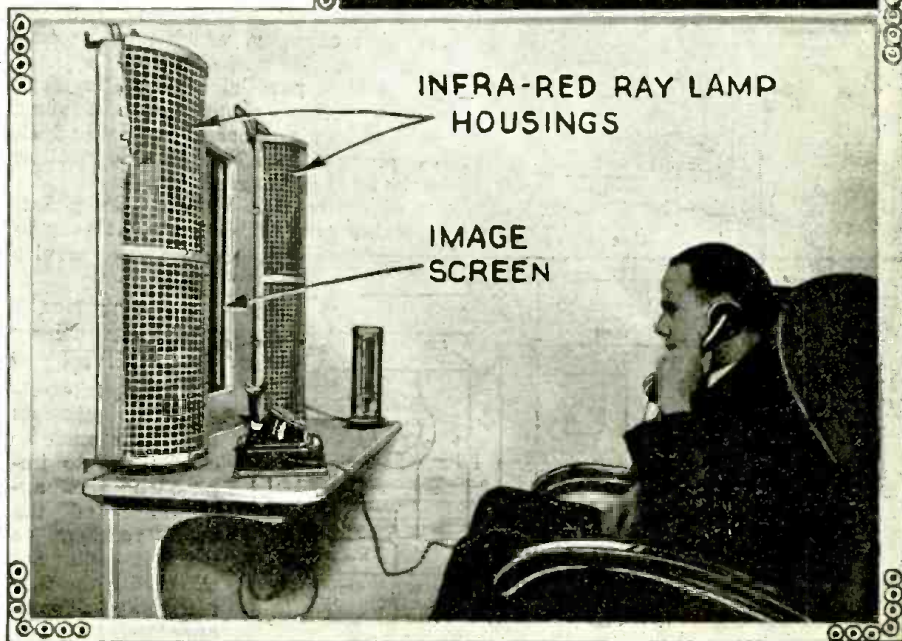

# INTERNATIONAL RADIO REVIEW

RADIO-CRAFT receives hundreds of magazines from all parts of the world. Since the cost of subscribing to each of these would be prohibitive for most radio men, we have arranged with technical translators to prepare reviews for our readers.

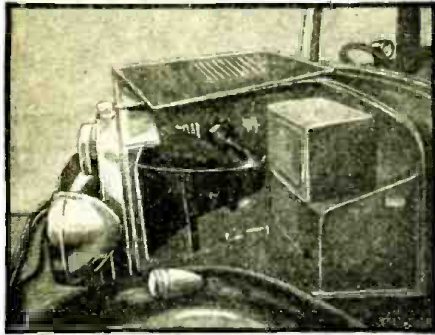

Fig. A. The speaker mounts over the motor.

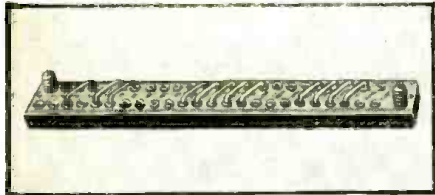

Fig. B. A substitution resistance strip.

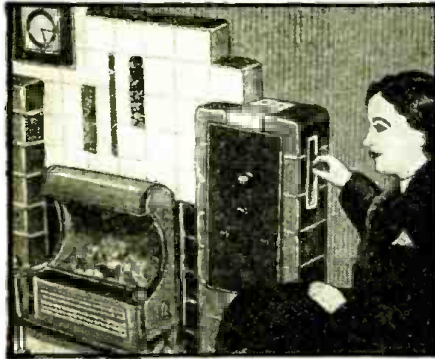

Fig. C. The portable fireplace with radio.

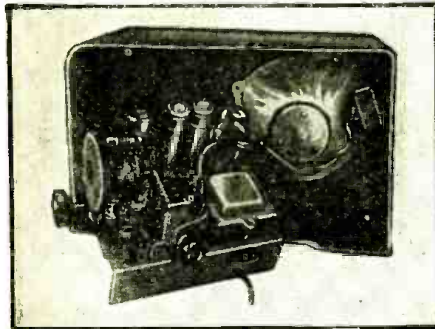

Fig. D. The appearance of the reflex set.

## A MOTOR-COMPARTMENT AUTO P.A. UNIT

IN A SURVEY of the P.A. units commercially available in England which appeared in *Wireless World* (London) recently, an unusual type of mobile (auto) P.A. installation was shown.

As shown in Fig. A, this consists of a horn-type speaker, having a diaphragm-type, permanent-magnet dynamic unit which is mounted under the motor hood and facing the radiator, so that the sounds are projected in the direction toward which the car is facing.

The amplifier is also mounted in the motor compartment of the car, and is secured to the fire-wall. This leaves the interior of the car entirely free, with the exception of the microphone and the phonograph turntable. The latter is in a small portable case which is opened only when in use.

This installation is an interesting departure from most auto P.A. systems which take up considerable space in the car.

## A WIDE-RANGE REPLACEMENT RESISTOR

IN RADIO service work, it is often helpful to have a calibrated variable resistor available to replace burned-out units in receivers being repaired—especially if the original value of resistance is not known.

A useful wide-range replacement resistor assembly which is available in France is shown in Fig. B. This unit was described in the latest issue of *Toute la Radio* (Paris).

It consists of 24 wire-wound resistors of suitable resistance, and current-carrying capacity, which may be connected in a wide variety of combinations, both series, parallel and combinations of both. These connections are made possible by a number of jumpers which are plugged into tip jacks connecting to the ends of the resistors.

The entire unit is housed in a flat, insulated case which makes it easy to

carry on service trips.

## A FIRESIDE RECEIVER

MANY interesting attempts have been made to conceal or to improve the appearance of the radio receiver, so that it will not clash with the furnishings in well-appointed homes.

At a recent exposition of household electrical appliances, held in Crystal Palace in London, an all-electric fireplace was displayed. This unit which is installed in the home as an integral unit, contained an electric radiant heater, an electric clock and a complete radio receiver.

As shown in Fig. C, the fireplace radio set is mounted in the right wall of the piece, with the control panel in the front, the speaker grille in the top and the on-off switch at the side.

This interesting radio-fireplace was described in the latest issue of *Wireless World* (London).

## AN AUSTRIAN "BABY" REFLEX

AT ONE time, a few years ago, the reflex receiver was the most popular circuit used by radio set builders. Theoretically this type of circuit gave the high gain and volume of the multi-tube receiver, yet it had the low battery drain and economy in cost of parts of the 1- or 2-tube receiver. Of course, we all know that these sets did not do all they were supposed to, and with the introduction of tubes having economical filament requirements and more amplification, the reflex faded out.

In Europe, however, this circuit has never been completely out of the picture. Every once in a while an interesting reflex using modern tubes is described in magazines either of a commercial or of a set constructor's nature.

In *Radio-Amateur* (Vienna) recently a tiny 2-tube A.C. reflex was described. This is a manufactured set, but since the circuit was given, we are reprinting it for those who might like to try it (see Fig. 1). The tubes are: an R.F. pentode, V1, and a full-wave rectifier, V2. The coils, L1, consist of a regular T.R.F. aerial coil with an aerial trap circuit to increase the apparent selectivity and eliminate any powerful locals which might otherwise cause trouble. Coil L2 is the secondary or grid coil of a T.R.F. coil similar to the secondary of L1.

It will be noticed, in Fig. 1, that a copper-oxide rectifier is used as the detector. This can be replaced with a fixed crystal detector, since the copper-oxide units are not generally available in the U.S. for R.F. rectification.

The values of the remaining parts are all indicated and should be readily obtainable. The output transformer of the speaker should have a very high primary impedance, as the plate resistance of the R.F. pentodes, such as the 58 and 6K7 is quite high. The value of cathode resistor R depends upon the characteristics of the tube used and for the two types mentioned above should be about 250 ohms.

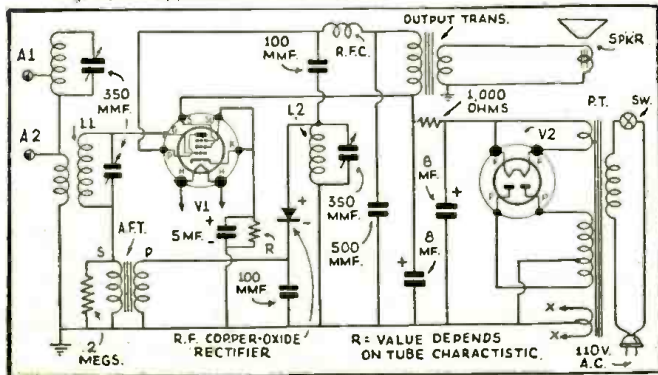

Fig. 1. The circuit of the reflex set, with modern tubes.



# THE IMPORTANCE OF INTERLACED SCANNING

A television pioneer who, in 1931, set the entertainment world agog when he demonstrated 10 x 10 ft. images on the stage of the Broadway Theatre, New York, discusses in this exclusive article to Radio-Craft one of the most vital developments in television technique.

U. A. SANABRIA

INTERLACED scanning is a subject about which we today hear a great deal. Those who have not pioneered television would be inclined to think that this is something new, but interlacing has been investigated over a period of many years, and in fact, the quantitative constants have been rather well established.

Those engineers who have concentrated chiefly upon some of the electrical phases of television without much considera-

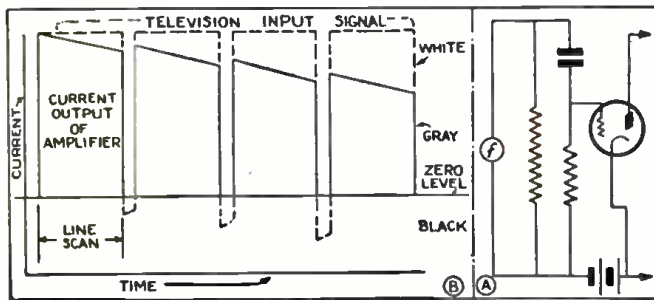

Fig. 1. The effect on the image of current lag in the amplifier.

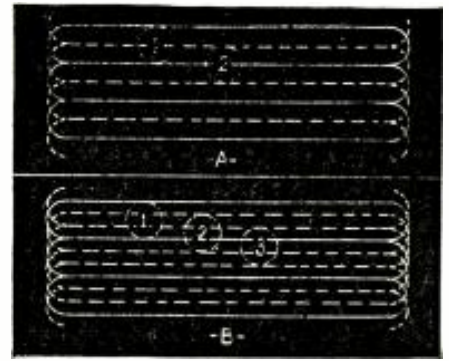

Fig. 2. Two different methods of interlacing.

tion of the scanning system are naturally surprised to find an improvement when they simply interlace the scanning lines alternately with each successive scan. Now, interlaced scanning is an old story to the partially initiated if we call it "offset scanning." In fact, an interlaced scanning system of the type up for consideration at the present time is simply another edition of the old 2-spiral offset scanning disc, which many years ago was shown to be a disadvantage rather than an advantage, for here the picture appeared to "wobble" within itself at very high scanning speeds rather than to flicker "over all" like a single-spiral scanning disc did.

## ADVANTAGES OF INTERLACED SCANNING

In our own laboratory, we first adopted a 3-spiral offset system as part of a system several years ago we called "definition multiplication" and "frequency interposition" although many better combinations were possible, but this one was "framed" easily. These offset systems of scanning, when properly used, contribute much to the art of television. The advantages are listed in Table I.

(Continued on page 122)

# MECHANICAL VS. CATHODE TELEVISION SYSTEMS

Comparative cost, size, complexity, efficiency, features, and physiological effect on the person viewing the image, are discussed.

WILLIAM H. PRIESS

THERE IS a great deal going on in television that is new even to the workers who have been long immersed in the problems of the laboratory. These new developments are mainly in the theoretical state; such for example, as the flying spark, the oscillating crystal and the multicellular systems. It is reasonable to say that they add ideas to the television art, which had borrowed much of its thought and equipment from many other arts, but nevertheless it is also reasonable to say that as we view the picture today, the race is to be run and the winner is to come from one of two schools.

## TWO SCHOOLS OF TELEVISION THOUGHT

These two schools are represented by the advocates of (1) the Braun cathode-ray and the advocates of (2) the mechanical systems. In particularizing the reference to the cathode ray, I refer to its inventor Braun, who dates back almost as far in the art as does Nipkow, pioneer among the devisers of mechanical systems. So little attention is given to this German scientist Braun that I find many television engineers seem unaware of his vital contribution.

We all know that whichever system—the Braun cathode-ray or the mechanical system—proves the best commercial answer to the problem, this system will be ultimately adopted,

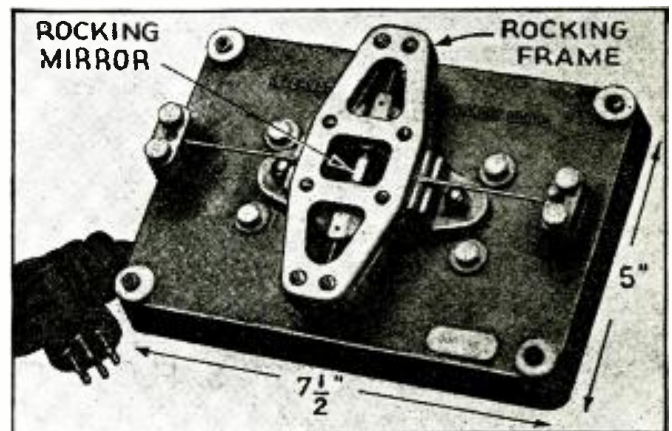

The appearance of the vibrator-type scanner.

because television inherently is, and must be, built on a single pattern; a single type, that is, insofar as the technical equipment is concerned. That there will be considerable waste of investment in order to make this choice, seems to be inevitable. Whoever buys a receiver based on the cathode-ray principle will be left holding the bag should the mechanical system become triumphant. Likewise will this be true in the case of all who buy receivers built on the mechanical principle should they at a later date find that the cathode-ray system is adopted.

As far as the investment in transmitting equipment is concerned, no tears need be shed in either case, because transmitter installations will be of sufficient flexibility to enable them to be altered to another form of system at a comparatively minor expense. Personally I believe in the "vibratory" mechanical system and cannot conceive how the cathode-ray system will be eventually triumphant.

Fundamentally all television sets have many parts and  
(Continued on page 126)

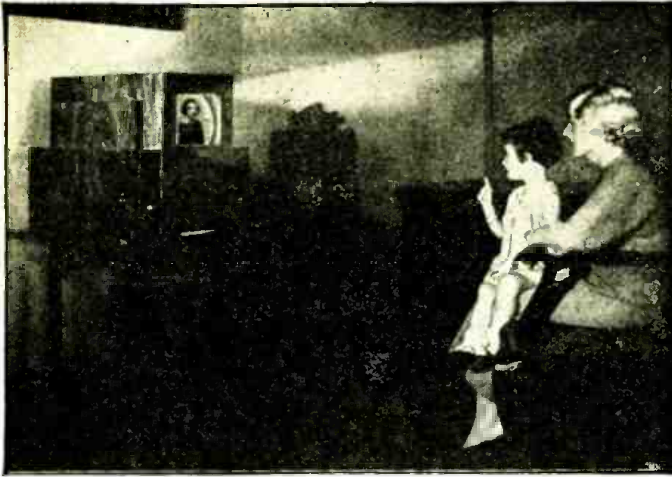

The approved "stance" for television reception. The set is a C. Lorenz model using a von Ardenne cathode-ray tube.

# TELEVISION AS HOME ENTERTAINMENT

Spotlighting television against the background of existing facilities, many vitally important conclusions concerning a workable plan for television become evident. (The author of this article—which was written exclusively for RADIO-CRAFT — was formerly vice-president of RCA.)

DR. ALFRED N. GOLDSMITH

**F**EW PEOPLE realize how little we know about the possibilities of television entertainment or education. In one foreign country the public is admitted into rooms of modest size, somewhat like a very small theater, where the lookers are permitted to witness a television program. Home receivers are not available for the assembly of information as to the public reaction. In some other countries television experiments are planned. In no other country is there a regular television broadcasting service with a large audience in the home whose reactions can be studied. So that we have no direct experience from which to judge.

To those particularly interested in radio and scientific achievement, television is certain to be attractive. The thought that pictures in motion can be carried through the air and reproduced on a glowing screen in the home is most appealing to the experimenter or the scientifically-inclined individual. The size and quality of the image and the nature of the program will be a minor matter to such enthusiasts.

However, television broadcasting will face a majority audience who will make other and more difficult demands. The average citizen who purchases a television receiver at some little cost will, after the first novelty has begun to wear off, seriously consider whether he is being entertained and instructed by the television pictures which reach him. Upon his individual reaction will be built a great body of public opinion which will determine the acceptance and rate of development of television broadcasting.

We cannot be sure that radio telephone broadcasting of today gives us a definite answer as to the response which will be given to television broadcasting. Broadcasting today requires little from the listener who may wander around the room carrying on other tasks or even reading a book against a background of soft music. In other words, broadcasting adapts itself to the listener and asks little from him unless his good taste or interest in the program prompts him to listen carefully.

(Continued on page 102)

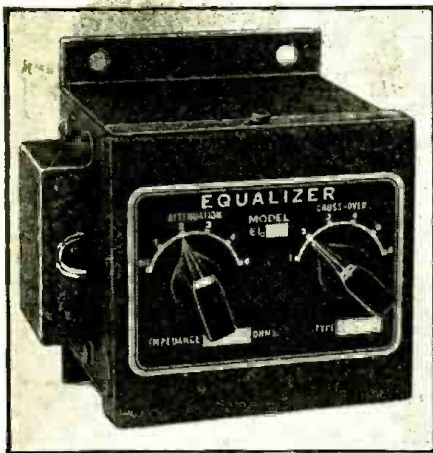

Fig. A. The equalizer in its metal case.

## A NEW VARIABLE-ATTENUATION EQUALIZER

The "cross-over" or position in the frequency range at which equalization starts is selected by a switch.

S. FLOYD STEWART

**T**HE RECENT development of a new variable compensating device, brings under effective control many of the

problems encountered in providing satisfactory reproduction in a public address system. This new product called the "Equalizer," simplifies the operation, since it is a highly variable unit with many possible combinations which assures proper correction for almost every condition.

The principal consideration in a P.A.

system is, of course, the reproduction of sound which can be clearly understood by the auditors, and on this basis, the type and placement of the equipment will be determined, but despite well-considered plans, there are certain factors which cannot be accounted for in advance, and which will cause un-

(Continued on page 107)

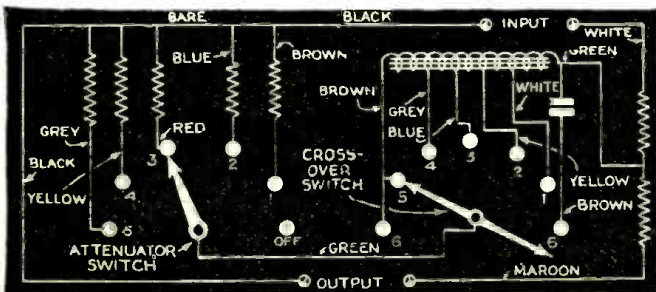

Fig. 1. The circuit of the equalizer, showing switches.

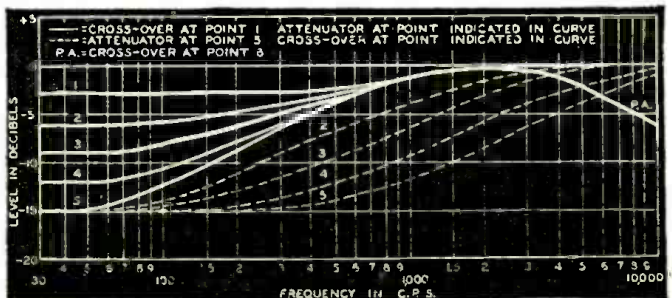

Fig. 2. Cross-over positions at different db. levels.

# HIGH-FIDELITY WIRED SOUND

A form of mechanized entertainment which is free from static, fading and interference.

N. H. LESSEM

**W**IRED SOUND, the newest branch of radio, bids fair to become another great industry. In several of the large cities of the United States enterprising organizations have conceived and successfully established some form of this unique entertainment service.

Notable among the New York concerns is the Muzak Corp. (a subsidiary of Wired Radio, Inc.) which supplies *high-fidelity* music—uninterrupted by announcements—to restaurants, clubs, hotels, reception rooms, ballrooms, and the like, 24 hours a day!

The charge for this wired-sound service (which is much more extensive in scope than those previously mentioned in *Radio-Craft*) is \$35.00 per month and higher, depending upon the size of the installation. Special arrangements are made with subscribers who desire indi-

vidual programs for certain occasions. For this purpose private wires from one of 5 studios at the program center in Manhattan, directly to the subscriber, furnish any desired type of music. The large A.&P. chain grocery organization appreciating the value of this service has had receivers installed in many of its New York stores. These receivers are connected via private wires to the central studio so that the music can be infrequently alternated with cleverly-worded advertising.

The advantages of this unique, high-quality entertainment service are numerous, as the following details disclose.

## OUTSTANDING ADVANTAGES OF HIGH-FIDELITY WIRED SOUND

The music, which is of the highest calibre, is arranged by a staff of expert music directors stationed at the studio. Appropriate music is always obtained at all times; if special music is desired a private line may be rented for the purpose. *The regular music program service is uninterrupted by annoying announcements.* There is no static present, no fading, no cross-talk or any of the other ills common to radio.

The spectre of mechanized music  
(Continued on page 108)

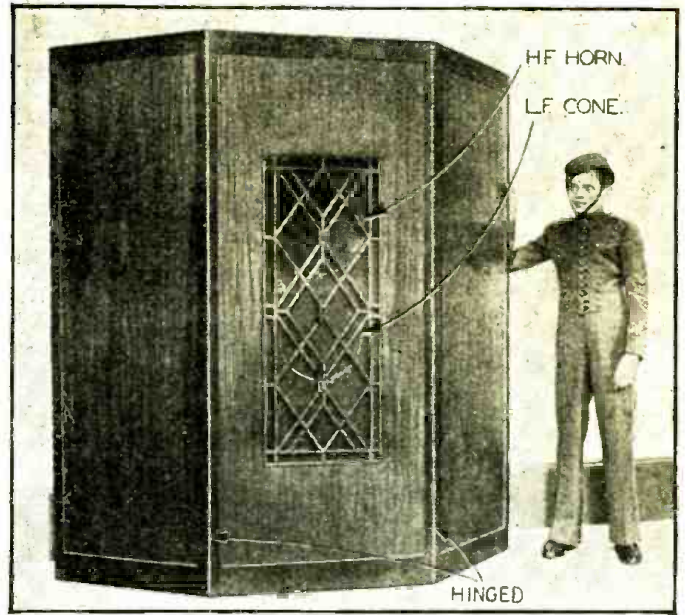

Fig. A. The removable "works" behind this folding baffle are shown in Fig. E. The two side wings are hinged to the center section so that it folds flat.



Fig. E. The amplifier and dual-speaker unit for the reproduction of high-fidelity wired sound. Wheels and a handle permit easy transportation.

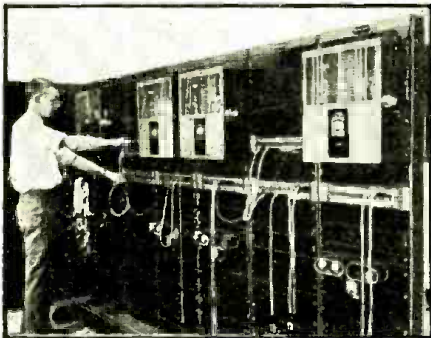

Fig. C. The panels of the 50-W. power amplifiers which boost the studio output to the level required for line transmission.

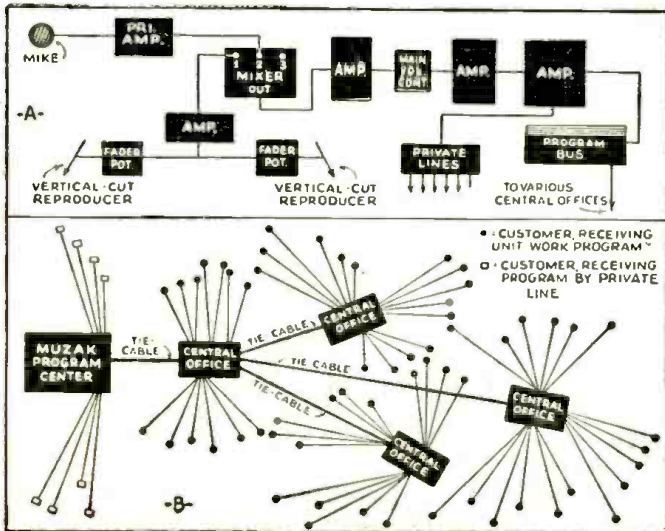

Fig. 1. Equipment set-up; and distribution network in the New York area.



Fig. B. Control room with monitor and turntables—studio in background.



Fig. A. Here is the beginner's set in use. All batteries are self-contained.

# THE "ELF"

## A 2-TUBE SET FOR THE BEGINNER

A novel portable receiver which uses the well known but seldom used space charge circuit. The use of this novel arrangement results in remarkable signal volume considering the low value of "B" voltage used, 15 V. being entirely adequate.

C. W. PALMER

**T**HE RADIO beginner and experimenter who has patience and some mechanical ability can make a tiny radio receiver which fits into a small card-file case, 3 x 6 x 4 5/8 ins. high, including everything—batteries and all—and which weighs less than 2 lbs. when ready to operate.

This set, which is called the ELF, because of its Lilliputian dimensions and weight, is an unusual combination of circuits known as "space charge" circuits in which the screen-grid tubes are worked in reverse—that is, with the screen-grid and control-grid reversed.

The set contains two tubes, both type 49s, one used as a space-charge regenerative detector and the other as a space-charge output tube. Because of this combination, the total plate voltage required is 15 volts with a tap at 7 1/2. This modest voltage can readily be obtained from two tiny 7 1/2 V. "C" batteries, since the current drain is also very low.

The filaments of the two tubes are connected in series, to keep the current drain at a minimum. This filament voltage is obtained from a tiny "A" battery supplying 3 V. Since the tubes are rated at 2V. each, the normal current drain of 0.12-A. is further reduced by operation at 1 1/2 V. This reduction in filament voltage did not cause any sacrifice

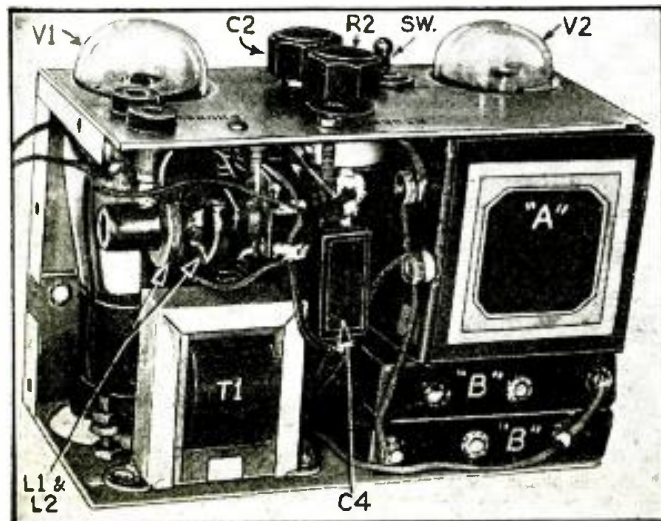

Fig. B. The compact arrangement of parts is evident in this chassis view.

in volume or sensitivity in the set—in fact with the circuit used, the volume was even greater at 1 1/2 V. per tube than when the normal 2 V. was used.

As for results, the set was designed primarily for head-phone operation, as a set for the traveling man or the radio experimenter who resides in the country, where battery costs run high. Due to its small size and light weight it is ideal for anyone who travels. When the set was tried, to the amazement of the designer there was enough gain on all the local stations to operate a magnetic speaker. Of course, the local stations were all within a radius of about 25 or 30 miles—but even the more distant stations from mid-western states were received with plenty of phone volume.

### CONSTRUCTION

The construction of the set does not require any particular knowledge of radio, beyond the use of handdrill, screwdriver and soldering iron. However if the set is to be made as small as the original, the builder must be able to fit parts into the smallest possible space.

For example, the variable condenser in its present position in the set will just pass the corner of the "A" battery; and the batteries had to be placed on their sides to make them fit at all. Also, the tubes had to be built right into the set, installed in their tube sockets for there was no room for removing them. However, they are operated at such conservative filament and plate voltages that, with the exception of dropping them, their life will be extremely long.

No drilling layouts have been included for the chassis,

(Continued on page 106)

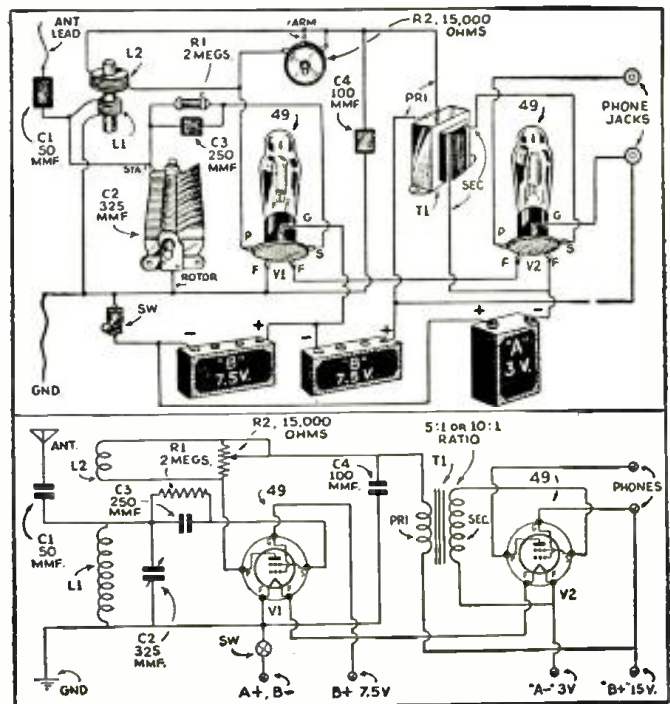

Fig. 1. Note how the connections are made to the tube grids in this circuit.

# THE "TRANSCCEPTOR" A NEW IDEA IN 5-METER TRANSCEIVERS

The operator of amateur station W2AMJ describes his latest contribution toward improved performance in 5-meter portable transmitting and receiving equipment.

FRANK LESTER

ONE SERIOUS shortcoming of the extremely popular 5-meter "transceiver" becomes more and more objectionable as the user becomes increasingly proficient in 5-meter technique. Inasmuch as the same antenna is used for both transmitting and receiving, and practically all of the other parts of the instrument likewise serve a dual purpose, some compromise in adjustment becomes unavoidable. This is especially true of the extremely important adjustment of antenna coupling. The best coupling for transmitting unavoidably proves too tight for receiving purposes, and prevents the receiving portion of the transceiver from super-regenerating properly. Some optimum value of coupling must be chosen

which will permit the transceiver to function in both the *receive* and *transmit* combinations; this means that the transceiver rarely gives the best performance of which it is capable.

In an effort to improve this situation and at the same time to preserve the highly desirable features of compactness and portability which have made the transceiver so widely accepted, the writer has designed a new 5-meter portable rig which has been given the distinctive designation of "transcepter."

This new *transcepter* idea has been incorporated in a complete, working instrument (shown in the accompanying illustrations) which measures only 15 x 15 x 7½ in. deep, and is therefore just  
(Continued on page 127)

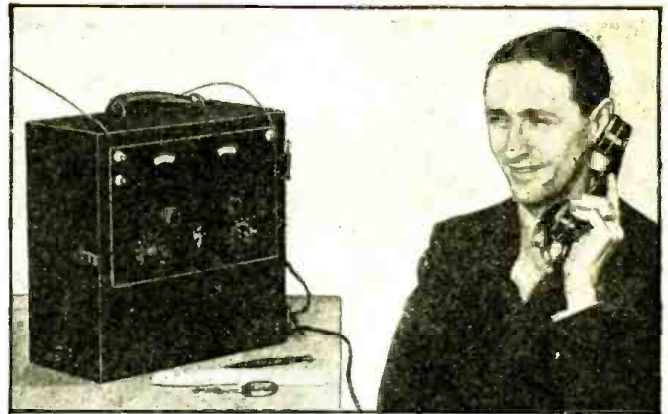

Fig. A. Here is Frank Lester operating the new set—a complete 2-way "station."

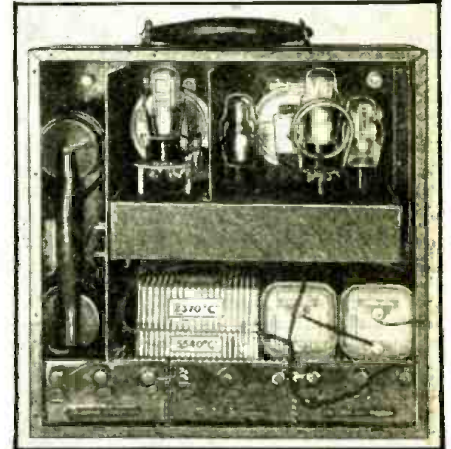

Fig. B. Rear view of the well-designed "transcepter."

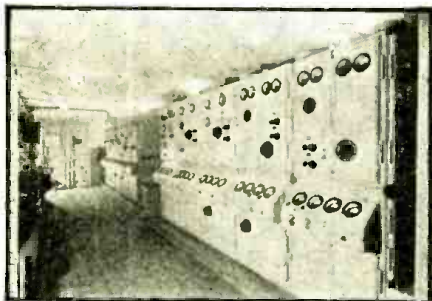

Fig. A. Transmitter with sight equipment at right.



Fig. B. Some of the fleet of 30 television trucks.

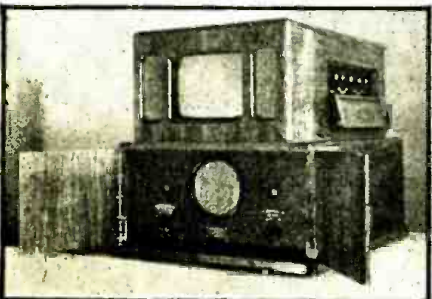

Fig. C. The complete television receiver described.

## TELEVISION IN GERMANY

A general resumé of the television status in Germany, chronicled by the operator of German amateur station D4RPU, including details of technical interest.

CARL TETZNER

IN GERMANY the idea of television started very early due to certain conditions mentioned below. A short time after discovering the electrical effect of the selenium-cell, Paul Nipkow had, in 1884, the fundamental idea to relay pictures one after another by analyzing in separate lines. He developed for this purpose the disc, known in Germany as the "Nipkow-Scheibe," which is used all over the world for mechanically scanning persons and movies, and also for mechanically receiving pictures in home-receivers.

Prof. Karl Ferdinand Braun was the first to see the possibilities of the cathode ray for measurements, at about the time that Nipkow invented his disc. The availability of the cathode-ray tube for television (in German "Braunsche

Röhre") was first proposed by Diekmann, Glaye and Rosing in 1907 and 1908. It is quite natural therefore, that the idea of television was very much discussed in Germany; but the technical mediums were not at hand at that time to permit developing the idea.

After the Great War, German laboratories of the factories and universities began zealously to develop television. One of the first was Prof. Karolus from the university of Leipzig, who was  
(Continued on page 123)



Fig. D. Unretouched photos received last month of German 180-line images.

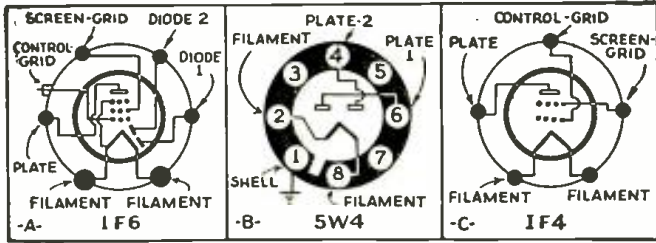

The basic arrangements of 3 of the latest of the new tubes.

# THE LATEST RADIO TUBES

The latest in new tubes, a battery power tube, a battery double-diode pentode and a rectifier, comprise this month's "crop".

AS USUAL the vacuum tube laboratories have been very busy—new tubes are being produced by the basketful, and we present herewith a few of the most interesting among this month's offerings.

The 1F6. The first is a double diode-pentode, with a 2 V. filament, and it is certainly a welcome addition to the battery line. It is similar in usage to the 6B7, in that the pentode section may be used for I.F., A.F., or R.F. amplification. The cut-off characteristics are midway between the sharp and remote types, permitting wide application. The diodes are brought out to separate pins, and may be used in the usual detector and A.V.C. circuits.

### 1F6 Characteristics

Filament voltage (D.C.) .....	2.0 V.
Filament current ....	0.06-A.
Plate Voltage .....	180 V. max.
Screen-grid voltage ..	67.5 V. max.
Control grid voltage ..	-1.5V.

Plate current .....	2.0 ma.
Screen-grid current ..	0.6-ma.
Plate resistance (approx.) .....	1 meg.
Amp. factor (approx.) ..	650
Mutual conductance ..	650 micromhos
Mutual cond. (at -12 V. bias) .....	15 micromhos

The 5W4. This is an all-metal full-wave rectifier designed for use where the D.C. requirements are moderate. The applied A.C. voltage should not exceed 350 V. per plate and the load current from the filter output should be under 110 ma. It is a high-vacuum tube of the filament type. Fig. 2 shows the operating characteristics, all taken with an input filter condenser of 4 mf. The tube is of the same size and has the same base connections as the 5Z4, but is designed for a lighter load.

### 5W4 Characteristics

Filament voltage .....	5.0V.
Filament current ....	1.5A.
A.C. plate voltage (per	

plate) max. ....	r.m.s. 350 V.
D.C. output current ..	110 ma. max.

The 1F4. Here is another tube of the 2.0 V. series, and is similar to the type 33, except that it takes less plate and  
(Continued on page 124)

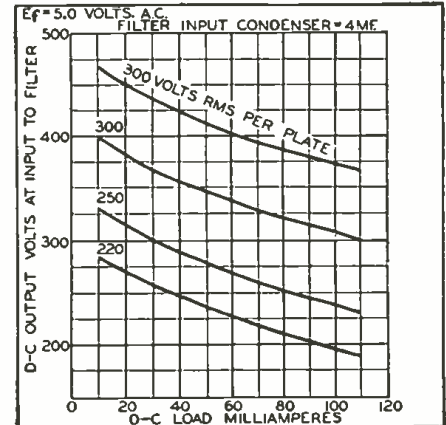

Fig. 2. Operating characteristics of the 5W4.

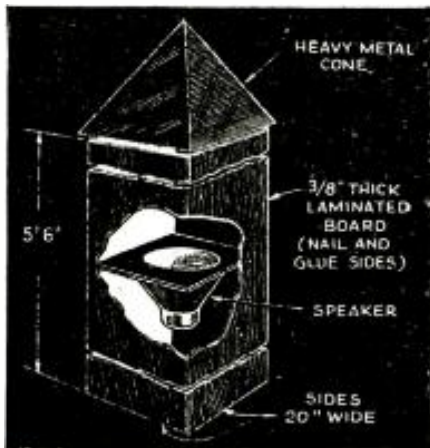

Fig. 2. Constructional details of the "sound columns" used to build up response in the "dead spots" caused by insufficient speaker coverage. The metal top deflects the sound down to the audience.

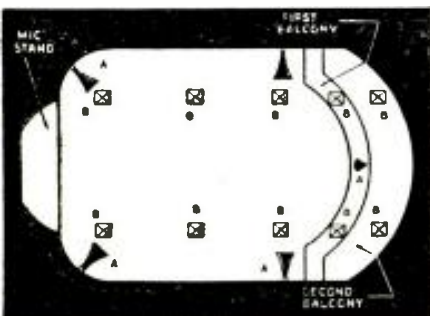

Fig. 1. Layout of an auditorium showing application of the new loudspeaker system, in comparison with the usual loudspeaker system, which provided insufficient coverage.

## HOW TO INSTALL A WIRED AUDIO P. A. SYSTEM

A method of eliminating dead spots in speaker coverage. Each "sound column" has its own amplifier and volume control thus reinforcing these dead spots.

### E. A. DENNIS PART I

THE PRINCIPLES of wired audio have been used as far back as 1893, by radio stations, advertising agencies and telephone companies.

By combining the principles of broadcast station network with 1-stage power receivers (which are built into each speaker unit) and, further, by making each unit universal in operation, it is possible to build a P.A. system both so flexible that any desired amount of output may be obtained and so arranged that the volume of each unit may be adjusted independently of all other units at, perhaps, one-third to one-half the cost of a high-powered address system.

To build this system of universal application, first, a master-control unit for the operation from microphones directly without preamplification is constructed. This should be of at least 5-stage universal type, such as described by the writer in the March 1936 issue of *Radio-Craft*, having an output of 3 to 4 W.

(This output must be in an absolutely humless form and the output transformer should have a 10,000-ohm and a 15-ohm output.) Secondly, each speaker unit should have a 1-stage push-pull amplifier in conjunction with the power supply (which should supply power for the speaker field as well as for the amplifying stage).

By this method, as many as 10 speaker units may be run off a single line, while the output line may be split up by pads into 5 lines and the volume of each line controlled independently of all other lines. Furthermore, by incorporating a volume control on the amplifier input to each speaker unit, each speaker may be pre-set to the volume desired for that particular location. One of the advantages of this system will be the elimination of feedback; and the securing of better tone, greater ease of operation and simplicity of installation.

Each speaker unit will be plugged  
(Continued on page 125)



Left, center, and right views of the exceptionally complete test bench of Raymow Distributing Co., on "Radio Row," N. Y. C. A half-dozen Service Men can work along the length of this table at one time, if need be.

There is an old saying that the truth often hurts — but that does not mean that we cannot profit from it, fellows!

## REFLECTIONS OF A SERVICE MAN'S WIFE

.....AILEEN IODICE.....

**I**T SEEMS only fair that we women who have nurtured a radio man in our bosoms should have our turn at the bat. We know, none better, the vicissitudes of depending upon radio for a living; and have the added advantage of seeing the customer's viewpoint as well.

Along with thousands of other radio men's wives I have seen radio steadily progress from the teething stage to the lusty age of physical combat of the present day. I know whereof I speak when I say there are many things wrong with the business of radio servicing that Horatio or whoever it was dreamed not of in his philosophy.

To begin with, there are altogether too many radio experts in the field. I have not stumbled upon this fact like Jack Horner with his plum. I've crossed swords with the best—speaking in an advertising way. Much of it has been fun. I admire a worthy opponent. But I am sorry to say that there is nothing uplifting in competing with the coterie of shingles flung out by crackpots in the name of radio service.

It makes the nice question in radio today not Who Called That Radio Man a Ditch-digger; but rather Who Called that Ditch-digger a Radio Man; i.e.:

"If I had not taken your wonderful course I should be out digging ditches . . ."—testimonial.

There is an odor arising from the business of radio repair that is increasingly hard to define. Eventually it may penetrate beyond the trade—and great may be the fumigation.

It has been said that radio service should be regarded as a profession—medicine, for instance. As long as mail-order houses continue to turn out "technicians" by the car-load, and we have as yet no law against quacks, it is ridiculous to attempt to place radio upon the same basis as the high calling of medicine.

It takes 10 years or more of study and application to turn out a doctor. In 10 payments or less many an "expert" blossoms into being, crowding into an already over-crowded field looking for the rich rewards offered in the advertisement.

I have no particular quarrel with correspondence schools. Many are excellent.

They merely turn out too many, too regularly, who are too wet behind the ears.

Each season's batch of debutantes proceeds promptly to get into the hair of an already harassed service world. Like modern Dick Whittingtons lulled by the chime of the Bow Bells, the new-fledged technicians set up in business, confident that when they burst upon a dazzled world it will proceed to prostrate itself in front of them.

Rather—it is a jaded and depressed service world that faces them. The first fine fervor has departed from the public appetite and even the old-timers are hard put to it to make both ends meet, in face of the cheaper-than-cheap

sets that are being unloaded by the manufacturers.

The manufacturer has cut the throat of the Service Man ear-to-ear with his price-wars; and then pretends to be concerned with his welfare by means of advertising campaigns allegedly on his behalf. Paid mouthpieces on the radio talk largely of his merits, but slashed tube prices and junky sets are released like locusts to smell out a stray dollar and gobble it up before it has a chance to look around. Vicious paternalism on the one hand; skulduggery on the other. When service becomes a thing that can be put up in sealed cartons and ladled out with the manufacturer's blessing, it will cease to be the individual thing it is today. The less the manufacturer concerns himself with the poor Service Man's problem, the less he worries about what the Service Man might or might not be doing; and the sooner he devotes himself to cleaning up his own domain, that much more quickly will his protegee take a new lease on life and proceed to do some business.

Among the Service Men themselves there is the snarling and wrangling that always follow too many extended paws and not enough morsels to go around. Yet—even as I write—more technicians are being ground out. More recruits are coming not only from correspondence schools but from the highways and the byways, armed with a few business cards setting themselves forth as experts, until it would seem that every mother's son who can hold a screwdriver right side up, and many who can't, have gone into radio.

It is such motley material that is being called upon to "Organize!"

Until organization means something, it will continue to be what it is today—a lost cause. The real craftsman takes pride in his work, and in his knowledge of his subject. Organization among radio men so far seems to be merely the joining of a group; the paying of a membership fee; the purchase of decorated stationery and business cards; a coat button—nothing else. What sort of impression as to the reliability of any "organization" must be arrived at when men who know little or nothing of radio flash a membership card to some high-sounding association and then proceed to brand themselves fools in their line?

I am informed that in a certain stronghold of Organized Service Men in Eastern Connecticut, one make of radio set using type 25Z5 tubes was absolutely banned. The initial cost of these sets was approximately \$8.95. When repairs were indicated the customer was informed that it would cost him exactly \$10.00 regardless of defect. The usual defect was the 25Z5 tube. In their own defence the Service Men maintained they were doing the customer a favor since these sets are continuously needing tubes and could not "honestly" be repaired. Their conception of the word

(Continued on page 112)

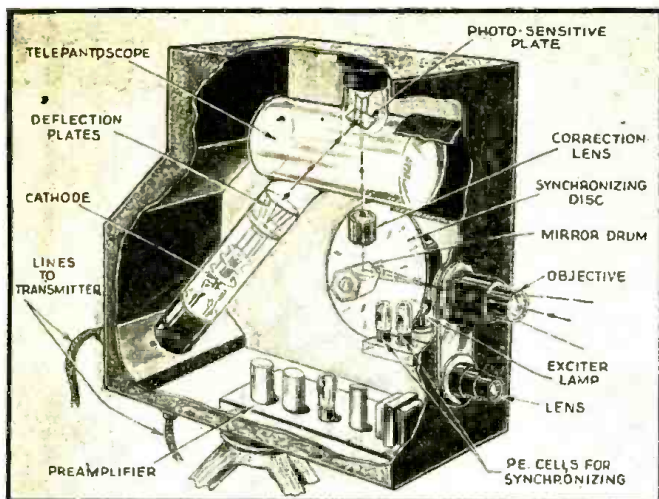

An interior view of the Telepantoscope described.

**I**TALIAN TELEVISION progress does not appear to have received a just degree of publicity, since little has been published concerning its television activities—particularly, those of SAFAR (Societa Anonima Fabbricazione Apparecchi Radiofonici), under the able direction of the "Zworykin of Italy," Mr. Arturo Castellani, who first displayed his television equipment at the Radio Show in Milan, in 1930.

The latest progress of the Castellani-SAFAR television system is a Télépantoscope, a television camera for direct pick-up, which is at present used for the transmission of a 240-line image, but has all qualities claimed for a 340-line transmission. The nucleus of this new camera is a very ingenious combination of a photoelectric cell with a cathode-ray tube. This combination is used in the direct pick-up devices designed by Zworykin and Farnsworth in this country.

It is well known that the experiments using ordinary photoelectric cells for direct pick-up have not been very successful because of lack of sensitivity in the photoelectric cells. Mr. Castellani increased the sensitivity of such a photoelectric cell by means of a very interesting trick. He uses

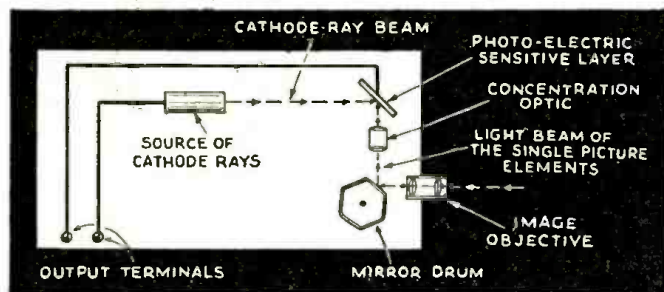

The theoretical electrical and optical actions of the Telepantoscope scanning tube. Note how the cathode ray acts as a "Connecting wire" to the P.E. cell.

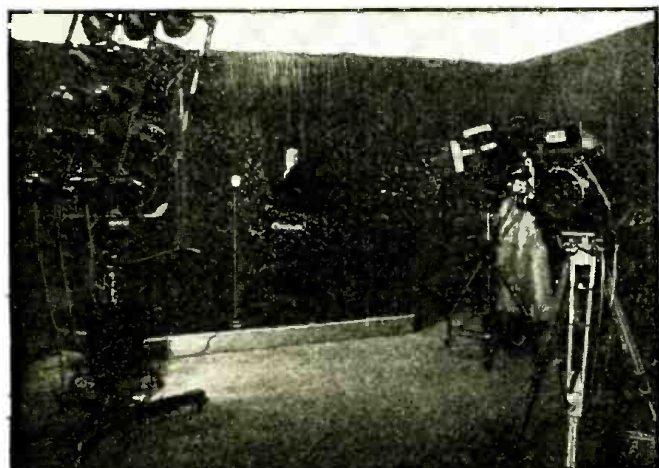

An action view of the SAFAR-Castellani system studio.

# TELEVISION PROGRESS IN ITALY

The work of Arturo Castellani—"the Zworykin of Italy"—is described. His Telepantoscope camera and 9 x 12 in. image receiver attest to his technical ability in this field.

the electron beam as produced by a cathode-ray tube as a "pulling" device. That means, expressed in simple language, that the electron beam of a cathode-ray tube "touches" the surface of the photoelectric cell, and provides by this an "easy going" road for the electrons, as radiated by the photoelectric cell. The cathode-ray beam operates by this trick as if a small brush, made of very fine litz wires, were moved across the surface of the photo-sensitive layer of the cell.

It is easy to understand that this "touching" electron beam decreases the resistance of the photo-cell against the radiating photo-electrons to nearly zero. The electrons radiated by the photoelectric cell are thus increased in speed. Increased speed of electrons might be compared with an increase of sensitivity, and this is the very point Mr. Castellani was driving for.

Compared to similar devices developed by Zworykin and Farnsworth the Télépantoscope operates with mechanical scanning devices. A tiny rotating mirror drum scans the image and reflects the single picture elements into the photo-cell part of the Télépantoscope.

The Télépantoscope transforms these light impulses into comparatively powerful electric impulses in the range of 50 microvolts which are led directly to a small preamplifier. This preamplifier is of normal design but has a flat response curve from 25 cycles up to 1,000,000 cycles.

Since the dimensions of the Télépantoscope tube, of the scanning mirror drum and the preamplifier are not of very large dimensions all these parts are installed into a cabinet of about the same size as an ordinary movie camera.

The television receiver has a screen of 7 x 8 ins., and as reports from Italy indicate, the performance obtained with this receiver is of a high entertainment value.



The heart of Telepantoscope system, the tube (held by Mr. Castellani).



FIRST PRIZE.....\$10.00  
 SECOND PRIZE..... 5.00  
 THIRD PRIZE..... 5.00

**Honorable Mention**

EXPERIMENTERS: Three cash prizes will be awarded for time- and money-saving ideas. Honorable mention will be given for all other published items. Send in your best "kinks"!

# SHORT-CUTS IN RADIO

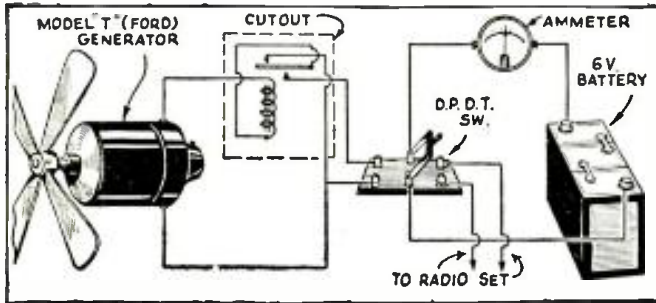

Fig. 1. A low-cost way to make a power supply for use in the camp, or on the farm.

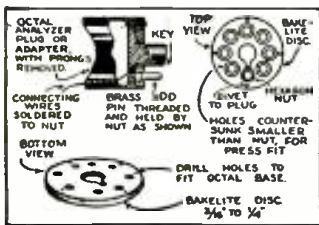

Fig. 2. A "universal" octal base plug.

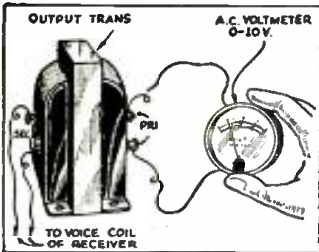

Fig. 3. Boosting meter range.

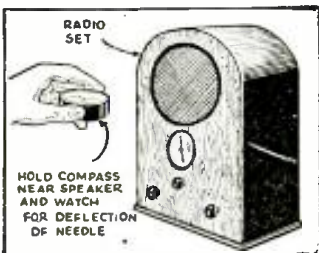

Fig. 4. Compass aids in service work.

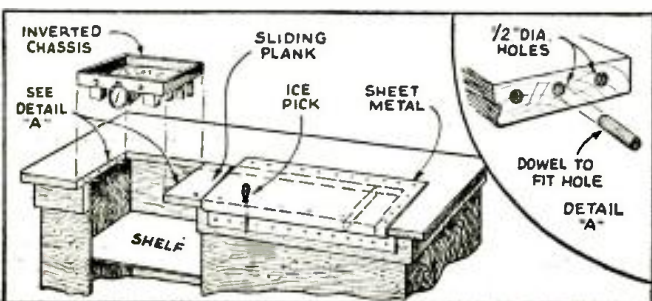

Fig. 5. How to build your work bench so that a chassis may be safely inverted.

8 pin holes are counter-sunk to such size that small hexagon nuts may be pressed in. The leads from the cable are soldered to these nuts. The pins are turned from brass rod and threaded so that they may be easily unscrewed when necessary. This plug is the equivalent of a whole handful of adapters.

PAUL C. MILLER

**THIRD PRIZE—\$5.00**

**INVERTED-CHASSIS HOLDER.** This chassis holding scheme is very handy and it may be converted into a substantial part of the bench when not in use. The essentials are shown in Fig. 5, the shelf under the bench being used for support of speaker or midget cabinet, leaving the top of the table entirely clear for the test equipment. A series of holes is drilled along the edge of the sliding member to coincide with holes in the sheet metal section, so that the ice pick, when placed through the two, will prevent the sliding piece from moving out of place. The dowel pins are moved into such holes as are most convenient for the particular chassis under repair. It is preferable to cover the metal portion of the bench with insulating material, such as linoleum.

GEORGE F. BAER

**HONORABLE MENTION**

**OUTPUT METER.** An ordinary A.C. voltmeter may be used as a sensitive output meter by connecting it with an output transformer as shown in Fig. 3. Without the transformer, the meter will not give a satisfactory reading on the low volume required when testing receivers which have A.V.C.

HOWARD J. SURBEY

**HONORABLE MENTION**

**"DEFECTIVE SPEAKER" TEST.** This may be made without touching the receiver and is often quite a time saver. With the compass held near the speaker as seen in Fig. 4, a sharp movement of the needle will be seen when the set is turned on, if the speaker coil and the energizing system are in good condition. Under certain conditions

it may be necessary to hold the compass closer than shown.

LESTER MULVEY

**HONORABLE MENTION**

**AUTOMATIC "PHONO-P.A." SWITCHING SYSTEM.** With the scheme in Fig. 6, the amplifier (used in sound trucks, etc.) is left working continuously and the phono pickup will work all the time until the microphone is lifted from the hook, which cuts out the pickup and cuts the mike into the circuit. The mike current is also controlled by the switch, so that it is not left on when not in use. The variable resistor, V.C., controls volume of both pickup and mike, but a separate control may be used for each to provide greater flexibility. A low-impedance pickup must be used. The hook for the mike in the original apparatus was made of No. 12 hard-drawn copper wire.

D. V. CHAMBERS

**HONORABLE MENTION**

**SOCKET-HOLE DRILLING TEMPLATE.** The template shown in Fig. 7 is used for drilling out the holes in octal sockets which have only the alive pin-holes open, making it unnecessary to use many adapters for

(Continued on page 109)

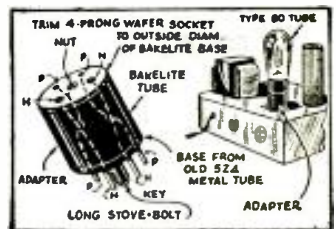

Fig. 8. Testing defective filters.

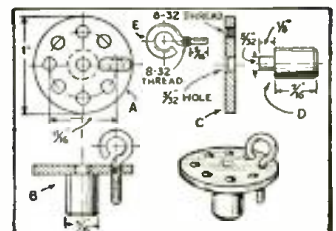

Fig. 7. Octal drilling template.

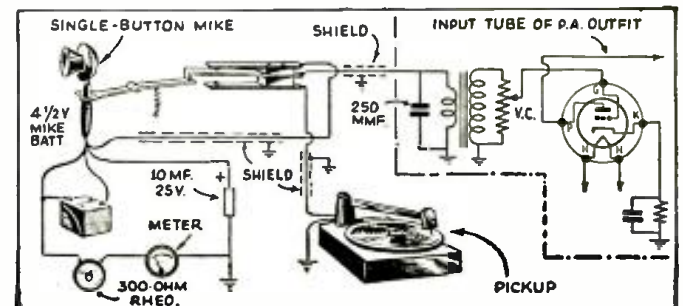
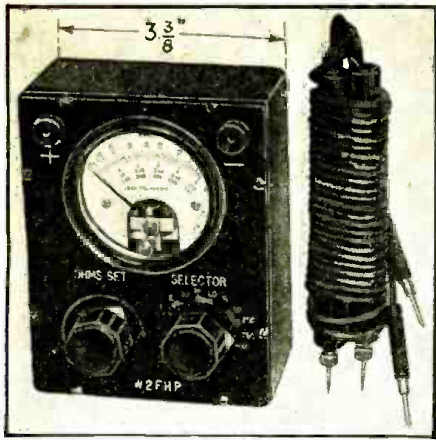

Fig. 6. The phono pickup is cut out by simply lifting the mike from its hook.



# MAKING A MIDGET MULTI-PURPOSE METER

A pocket-size meter unit which combines both voltage, current and resistance scales for the radio man.

H. G. McENTEE

Fig. A. The appearance of the multi-meter unit with its test leads. Note the small size.

**S**ERVICE MEN and experimenters have often felt the need for a small, compact test instrument, particularly one with which to test continuity. This means one or more ohmmeter ranges, and since the meter is required for these, we may as well have a really handy piece of apparatus by adding several volt and milliampere ranges.

The tiny tester described here is just such a unit. It is not intended to replace the larger and more versatile test sets, but merely to supplement them. It is small enough to be carried in a pocket and is highly convenient, since the ranges are all selected by means of a special home-made switch. This switch and the ohms scale adjuster are the only controls and the only items on the panel, other than the meter and 2 tip-jacks for the test leads.

The ranges should be selected by the builder according to what he is most apt to need. For example, the country Service Man would have no need for the 750-V. scale used in the original since his field is mainly among battery receivers. On the other hand, those who work with transmitting ap-

paratus may require the 750-V. or even a higher scale.

The A.C. range is not calibrated, but was added as an afterthought and is useful for output tests and alignment work. It is connected in a rather peculiar manner, but this was necessitated by the fact that only 2 poles are available on the rotary switch and it was felt undesirable to add a separate switch for the A.C. range. (In fact, there was no room!)

The box is made of 3/16-in. bakelite throughout and is  
(Continued on page 125)

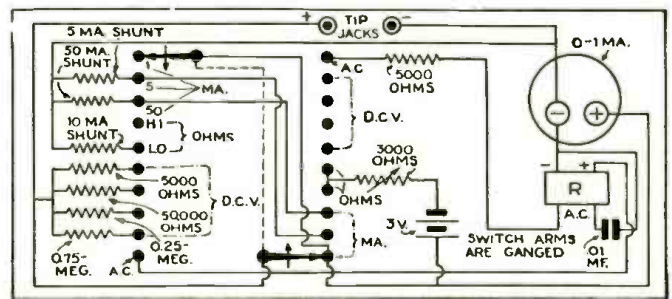
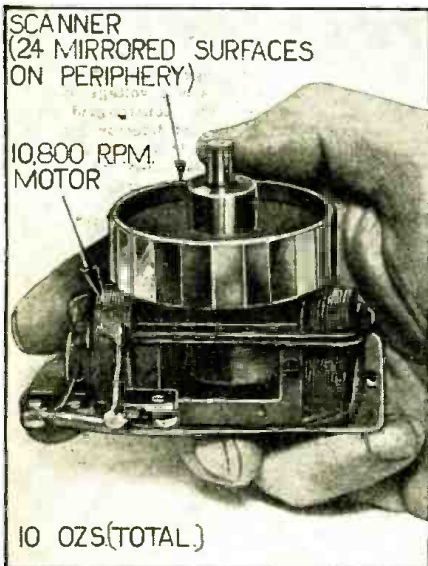
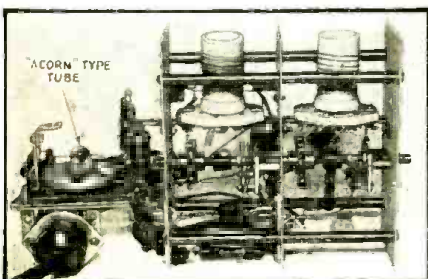

Fig. 1. The circuit of the unit with its home-made switch.



The Peck mirror scanner which is capable of high definition reproduction.



An ultra-high frequency amplifier using acorn tubes.

# THE OPTO-MECHANICAL SYSTEM OF TELEVISION

The author's opinion of the future development is based on the advantages to be gained by mechanical scanning.

WILLIAM HOYT PECK

**B**ELIEVE that the opto-mechanical system will always continue to occupy a major place in the visual entertainment field.

It is, in fact, my belief that mechanical scanning is far more practical than the other system at this stage of the science and that, because of features inherent in each it will always be the most satisfactory method for use in the home. One should not, of course, compare the present highly efficient mechanical scanners of today with the comparatively crude ones of a year or two ago—The reflecting lens system which I have developed and patented differs from the old pinhole disk or simple lens systems as a modern super-heterodyne from the crystal sets of 1920.

Prime requisites for a home-television receiver are low first cost, simplicity of mechanism, circuits and operation, ease and cheapness of replacement of the parts which naturally deteriorate with use and, highly important, safety to the user.

Proponents of the cathode-ray receivers generally consider only the light source and scanner; they do not consider the 6 or more additional tubes which are required to maintain the "sweep circuit" which controls the motion of the electronic beam. Nor do they mention that each of these extra tubes must have its own oscillator coils, condensers and so forth; in addition to a separate power pack, including rectifier, chokes, condensers and resistors, to supply the fearsomely high voltage which the cathode-ray-tube requires.

On the other hand, the mechanical system requires no more tubes than are found in the average radio receiver—it uses no extra circuits. It consists merely of a light source (an ordinary automobile headlight bulb), a light modulator tube and a tiny disk driven by a motor as small and dependable as that used in an electric clock. This motor is driven by the signal received over the air, and thus automatically synchronizes the disc

(Continued on page 124)

# ANALYSES of RADIO RECEIVER SYMPTOMS OPERATING NOTES

**Atwater Kent 43.** The type 26 tubes in this receiver would not light. I suspected the filament winding, but a test showed it to be in good shape. No voltage could be measured at the soldered connection on one of the lugs which connects to the cable from the type 26 tube sockets. Reheating the joint with a soldering iron made a firm connection and presto, I had light.

**Lyric 90.** This set sometimes had a hum so loud that it would drown out reception. At times it would work perfectly well for an hour or so before the hum would start. It was cured by shunting a 2-mf. condenser across the filter condenser, shown as C2 in Fig. 1A.

**Zenith Model LH.** To get rid of the hum in this receiver I was compelled to replace the following parts: 0.05-mf. A.F. coupling condenser, 0.2-mf. 47-tube bias bypass, 25,000-ohm detector cathode resistor, 0.5-meg. and 0.1-meg. 47-tube bias resistors, 0.1-meg. power-tube grid coupling condenser, 10,000 ohm S.-G. supply resistor and 1 detector choke coil. These parts are all shown in Fig. 1B. Replacement of any of the old parts back into the circuit would cause the hum to return.

**Zenith 52.** The complaint was weak, intermittent reception and flickering of the pilot lamp. The trouble was found in the lamp itself—the 2 stems which support the filament were almost touching each other. In operation the heating effect of the filament would cause the 2 stems to come into contact, thus shorting-out the pilot light and also the filament of the type 45 power tubes. See Fig. 1C.

WILHO G. MYLLYKANGAS

**Any Receiver.** The set was a Sparton table model but that doesn't matter. The complaint was that the set was noisy, and it certainly was. Removal of the antenna lead showed that the noise was outside of the set, and since it was an intermittent rasping sound, it might be anything from a defective electric light in the house to a heating pad down the street! It was a night call so all electric lights were turned off, one by one, with no success. I was about to give up and tell the owner I couldn't do much about it when I thought of the

possibility of poor fuse contact. Check of the branch fuse box showed no trouble, but inspection of the main fuse box showed a loose connection on the main switch. When this was tightened there was no more noise.

PHILIP C. TAIT

**A.C.-D.C. Receivers.** The older models of this type are often made inoperative due to the leads which were soldered to the high-watt resistor coming loose from the heat. In repairing, and to avoid future annoyance of this type, bolt the lead to the resistor. This will prevent a recurrence of the trouble.

N. H. DAVIS RADIO SERVICE

**Kolster K-21.** It is possible to receive a shock when installing a ground wire on these sets if the line plug is inserted the "wrong way" in the outlet so that the ungrounded side of the line is connected to the chassis through the extraordinarily large line grounding condenser in the set. As the other side of the line is grounded, almost the full line voltage exists between the chassis and the ground pipe. To preclude all chances of receiving a shock, the line grounding condenser should be disconnected by clipping and taping the orange lead emerging from the condenser block. (It is best to replace the large condenser with one of about 0.01-mf. —Editor)

If the receiver howls loudly for about 10 seconds after the power is turned on, it is due to the extra piece of green wire that is connected to the 1st A.F. tube grid in addition to the connection to the transformer secondary. This short piece of wire is laced in for a way with the power supply wires for the tuner but its other end is not connected anywhere and it serves no useful purpose. Its removal will stop the howl.

Lastly, to greatly improve the sensitivity, the grid suppressor in the grid of the 3rd R.F. tube may be removed. I found this was the only suppressor that could be removed without causing oscillation at the high-frequency end of the dial.

**SPARTON 620.** Lack of sensitivity in the Sparton 620 and other sets using button-type sockets in the R.F. and detector stages is often caused by the tube prongs not mak-

ing contact with the socket prongs. This is generally due to the customer rocking the tube around while withdrawing it, thus bending the socket prongs out of shape. These sockets are only held together by one bolt through the center so it is an easy matter to take them apart and bend the prongs back in shape. To avoid future trouble, the customer should be instructed to pull the tube straight out when changing it.

JAMES G. RAPP

**Zenith Chassis No. 5052.** The writer has serviced a number of these machines on complaints of being apparently unbalanced. After balancing carefully, according to factory directions, the set would perform normally at the higher frequencies, but would remain out of balance at the opposite end of the dial.

After carefully checking the machines several times without locating the trouble the 2nd I.F. transformer was replaced as a matter of experiment, and the change immediately restored normal operation.

A careful examination was made of the unit both before and after removal from the chassis without revealing any trace of a defect, but nevertheless the change effected a cure in each case.

**RCA-VICTOR R-4.** Several of these sets have come into the shop on complaints of sputtering or "motor-boating" when playing at low volume. At high volume, however, operation is normal. This trouble can often be remedied by connecting a 0.01-mf. condenser from the screen-grid circuit to ground.

**Philco Model 19.** When this particular model plays from one to several hours and suddenly stops, resuming operation after the switch has been turned off for 15 minutes or more, it might be well to check the insulation between the plates of the compensating condenser which is across the 2nd I.F. primary. If the mica sheet which acts as the insulating agent is cracked the unit should be replaced. This defect often occurs in damp climates. The condenser is part No. 20 in the Philco diagram covering the model 19.

AL OLSON

**Majestic 25.** Stations between 550 and 700 kc. distorted with volume turned low; OK with volume on full. The trouble was found to be due to the primary of the 1st I.F. transformer being slightly off balance. These sets use twin detection and it was found that the I.F. transformers must be accurately aligned.

**SPARTON 193.** This set is in 3 sections, the selector, the R.F. amplifier, and the A.F. and power supply. The selector has 4 stages and it was found that the signal of local stations would come through by placing the aerial on the stator of the 4th stage but nothing came in through the regular aerial coil or through the 3rd stage. At first the trouble seemed to be in the 3rd selector coil but the coils were all tested for resistance and all 4 tested OK. Then each section of the gang condenser was tested for a short-circuit, but to no avail. After a lot of perspiring the trouble was traced to an open grid on one of the bandpass coils in the R.F. amplifier unit. These coils are wound in pies on wooden spools, the primary and secondary being wound together. The open connection was at the soldering lug so it was easily repaired and the set worked perfectly.

**Sparton 25 & 26 Super.** Another difficult trouble to locate was encountered in this model Sparton. The set was dead, although plate and screen-grid voltages checked OK. The strange thing about the set was there was a voltage of 100 V. between the control-grid and ground of the 1st-detector yet the secondary coil in this particular circuit, which is shielded under the chassis with other coils and is wound on a separate form from the plate coil, tested perfectly, yet shorting the coil out caused the set to play. So, a new coil was installed and the set then worked fine. (The defective coil had also stopped the A.V.C. tube from working.)

**Eveready Series 30.** Intermittent reception in this set was traced to a broken wire on the voice coil of the speaker and would keep opening with the vibration of the speaker, then would make contact again. The wire was not a loose break but was partly held by solder.

(Continued on page 103)

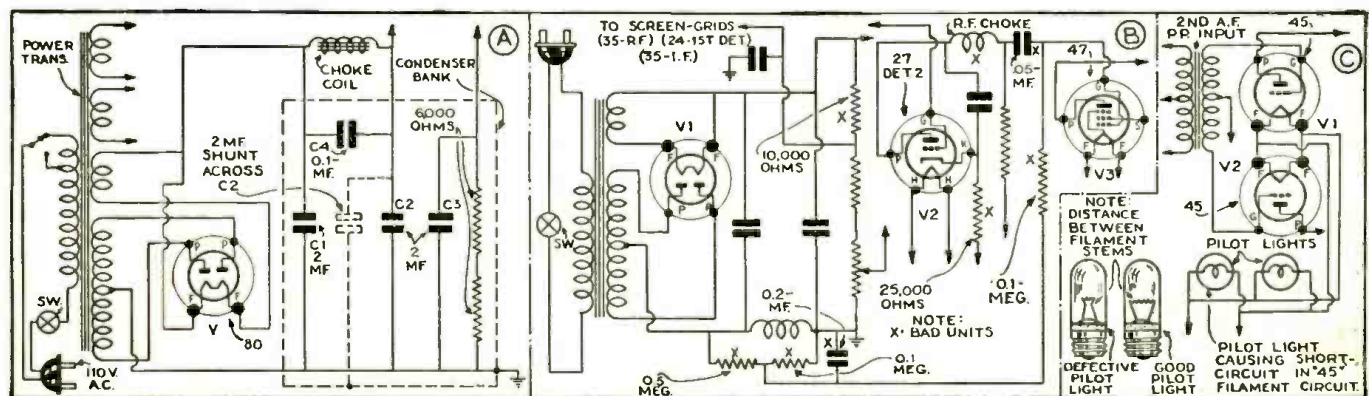

Fig. 1. At A, removing hum in a Lyric 90; B, 8 parts of this Zenith LH went bad at once; C, pilot light trouble which may be found in any receiver.

# ELECTRONIC MUSIC FUNDAMENTALS

Film recorded systems are specifically covered in this part of the series—both photographic and hand-made patterns.

## EDWARD KASSEL PART IV

**T**HE TREE of the development of electronic music shown in Fig. 11A is based on numerous patents and publications in this country and abroad, names and dates being selected for the most original invention or apparatus constructed by each inventor.

This article covers the production of music electrically by photographic film, optical systems, and light sources. Before going into the description of the instruments, producing music from the film, it is important to know something about the process of preparation and recording synthetically of the films used in those instruments.

Several recording devices are illustrated in Fig. 11. They permit the recording of wave patterns of various shapes on the film or other suitable recording material.

Figure 11B represents a recording device consisting of rollers on which a wide sheet of paper is drawn. Hand-made tracks are drawn in parallel rows, lengthwise, starting from the low frequency of 16 cycles to the high frequency of 8,000 cycles. The wavelength of each pattern is proportional to the frequency which corresponds to the track it is representing. An electric motor drives the rollers and carries the photographic film through a train of gears. A light source is focused on the moving film with the aid of an objective lens, exposures being made through a slit, the paper and film running in opposite directions.

Figure 11C illustrates a "flicker-box" which is designed for the substitution of paper rolls and produces the same result as shown in Fig. 11B. The flicker-box eliminates tedious work of drawing on paper, and by a simple change of recording cams, the desired wave pattern can be recorded on the film. It can be seen that the flicker-box has 8 slit apertures, through each of which an individual light source is focused by a camera objective lens on the recording film, each slit being opened and closed by the action of the cam rotating on a shaft from the train of gears in such a manner that while the first cam makes 1 revolution, the second cam makes 2 revolutions, the third makes 4, the fourth makes 8, etc. This arrangement permits the recording frequencies to double in number. Anyone knows that when the frequency of any musical tone is doubled, the same tone will be heard at a pitch an octave higher, so that the flicker-box is designed to produce simultaneously 8 octaves of some particular pitch. By displacing the flicker-box at 1/12 of the distance between each ad-

jacent aperture, and by placing the belt on another step of the cone pulley, and lacking up the film to the starting point, 8 recordings of high or low pitch are produced with the same arrangement. In order to record 96 tracks on the film, the flicker-box must be displaced 11 times. Using the flicker-box arrangement, films of any length can be produced while the arrangement shown in Fig. 11B has its limitations.

Figure 11D is an Eremeeff Universal Recorder, a similar arrangement as shown in Fig. 11C. Various cam shapes permit the recording slits and wave patterns on photographic film. This flicker-box is assembled in a plate which displaces itself on a frame before the lens of a camera in order to produce another set of recordings, providing that the spring belt is placed on another step of the driving cone pulley. For further details, see "Syntronic Music," *Radio-Craft*, August 1934.

Figure 11E shows simplified arrangements which experimenters are able to construct for producing recordings of slits or wave patterns. It is unnecessary to have a camera for this purpose. Anyone who can obtain a photographic lens, motor and 2 sets of worms and worm gears can construct a recorder as illustrated. Another advantage of this device is that by continuously revolving the drum with patterns drawn on it, any length of film can be produced.

Figure 11F illustrates an instrument for combining synthetically a number of frequencies with the aid of a stationary preadjustable mask. This instrument has a long film with rows of slits or wave patterns continuously running, with the aid of a synchronous motor and a stationary preadjustable mask, designed to pick up certain recorded tracks in order to produce synthesis of simple frequencies. It can be seen that when the light source with the optical system is directed on the films with the aid of inclined mirrors and the

(Continued on page 109)

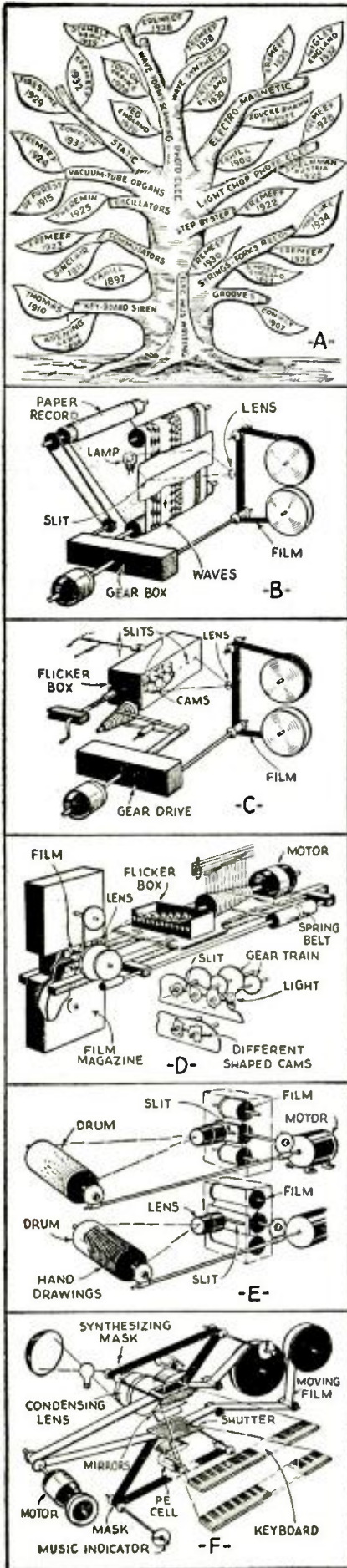

Fig. 11. Details of the different film systems.

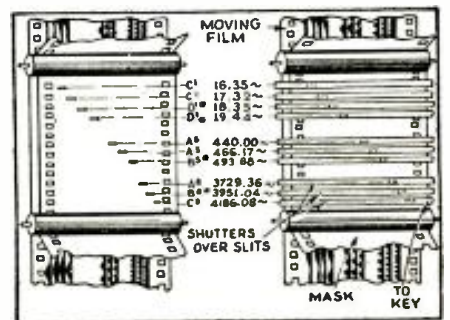

Fig. 12. Masks cover the film patterns.

# A FRENCH TELEVISION SYSTEM

A 60-line system using a mechanical scanning disc in the transmitter and a cathode-ray system in the receiver.

MARC CHAUVIERRE

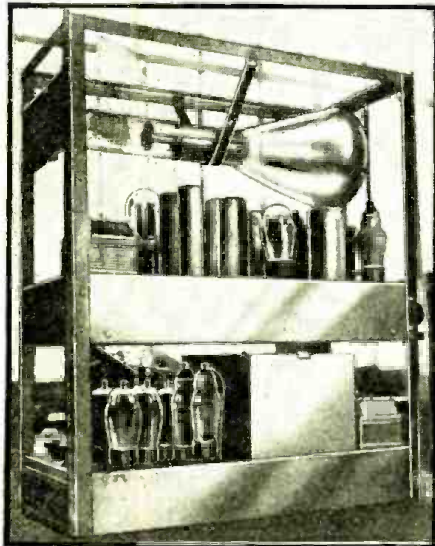

Fig. B. The 3-deck receiver chassis.

**W**HILE OTHER French television systems are well known in this country little has been published in America about the experiments (under the direction of the writer) in the laboratories of the Institute Marey, of Boulogne-sur-Seine, an institute better known as the Physical Laboratories of the Collège de France. This laboratory makes its television experiments in co-operation with the well-known Paris broadcasting station "PTT". Since this station is owned and operated by the French Post Office the television experiments have a kind of official character.

The most startling fact about these television experiments for an American observer is their extremely low-definition transmission. While in this country experimenters are busy improving the available 180-line television system to a 340-line reproduction, because it is believed that the fidelity of a 180-line

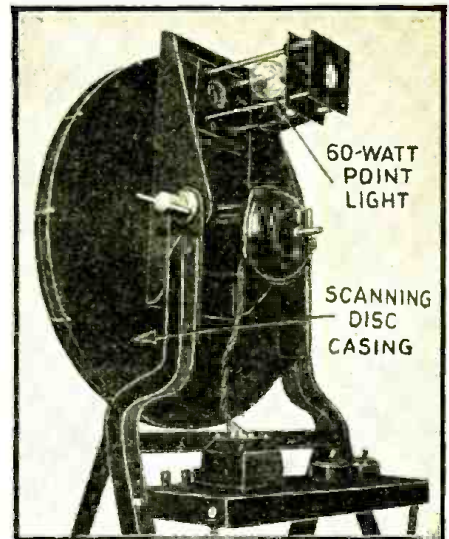

Fig. A. The scanner using a 60-W. "point" light.

performance is not high enough to satisfy the public, the writer still experiments with a low-definition reproduction, consisting of only 60 lines. However we transmit the internationally used 25 frames per second, and since interlacing is used, fairly good performance is obtained at minimum cost.

For the image pick-up a scanner is used which operates with a 60-hole Nipkow disk, but for the reproduction the rotating disk has been discarded and  
(Continued on page 103)

# A DUAL-MODULATED BEAT SIGNAL GENERATOR

Frequency modulation (wobbler) and amplitude modulation with a heterodyne oscillator make this unit unique.

E. L. GARRETT

**L**AST MONTH the wobbler or frequency modulator circuit of an interesting test oscillator which is designed specifically for use with an oscilloscope for set alignment, R.F. and A.F. measurements, etc., was described.

The oscillator with which this wobbler is used, or rather of which it is a part, is also technically of interest. Instead of the usual group of coils covering the intermediate, broadcast and short-wave ranges, this oscillator employs a beat-frequency circuit. This is unusual in an R.F. oscillator and some readers may wonder what advantages it offers over the direct inductance method.

The 5 bands covered by the oscillator are as follows: 1— 100 to 400 kc., 2— 400 to 1,700 kc., 3— 1.7 to 6 mc., 4— 6 to 15 mc., 5— 15 to 30 mc.

The unit employs 5 sets of small, individually-shielded coils arranged around the circumference of a revolving metal disc and switched into circuit by rotating the disc, thus changing the positions of the silver-plated contacts.

These 5 coils in conjunction with a small tuning condenser cover the frequencies from 30 mc. to the lower frequency end of the short-wave band. These coils with their 6C5 metal oscillator tube are used directly for short-wave alignment work.

In conjunction with the above-mentioned oscillator there is a fixed-frequency oscillator tuned at the factory to a frequency of 1,650 kc. For wavelengths above the range provided by the variable oscillator, this fixed-frequency oscillator is mixed in a 6L7 tube with the variable-frequency oscillator voltage thus providing lower or "beat" frequencies. Thus if the fixed, 1,650 kc. oscillator is mixed with a frequency of 1,750 kc. from the variable-frequency oscillator, the resultant output will be a frequency of 100 kc. (and is at the lower end of the intermediate-frequency band).

The advantage of this method is obvious. By using the small coils and small tuning condenser high efficiency is obtained on the short wavelengths, permitting an almost flat output to

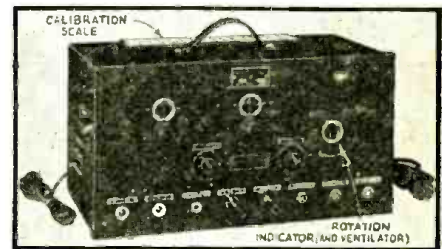

Fig. A. The front of the oscillator.

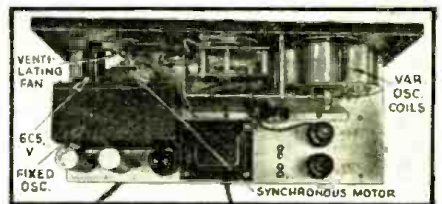

Fig. B. Interior of the oscillator and wobbler.

be provided over the entire spectrum. For the lower frequencies the inductive wobbler can be coupled to the fixed-frequency oscillator and thus the wobbler action, which is so necessary in aligning the intermediate frequency circuits of high-fidelity sets, in conjunction with an oscilloscope, does not detune the test oscillator as is usually the case.

The unit is also provided with an audio-frequency oscillator which is adjusted to a frequency of 400 cycles for fixed A.F. modulation in the adjustment of radio sets and A.F. amplifiers. This audio oscillator is modulated to a depth of 30 per cent which approximates the  
(Continued on page 108)

# AN IMPROVED TELEVISION CAMERA

First published technical account of the newest "movie-size", Farnsworth television camera! Details of the transmission characteristics of the system are given.

PHILO T. FARNSWORTH

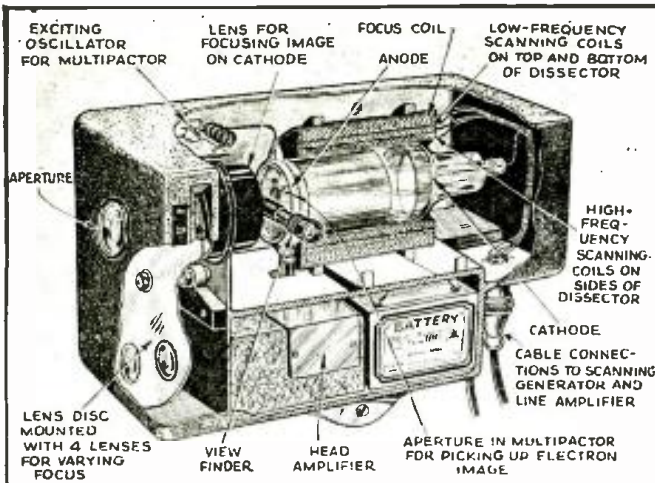

Fig. C. The television camera in phantom, to show the parts and their relative positions.

little space. The leads to the camera from the main control panels must be well shielded; received-image "microphonics" are due to vibration of these leads.

Improvements in the televiewing camera were concerned primarily with increasing the over-all sensitivity of the camera unit. Improvement began with getting better photoelectric emission from the dissector cathode, greater gain in the multiplier, and a more efficient head amplifier. The over-all sensitivity of the camera is such, that now, an illumination of 40 foot candles at the lens is sufficient for satisfactory television pictures. The final important improvement came in newly designed focusing and scanning coils, which help to produce a television image free from distortion and ripples.

(Continued on page 113)

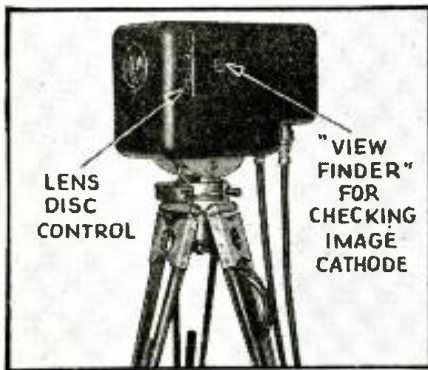

Fig. A. The camera mounted on its tripod ready for operation. Four lenses, for close-up and distant shots are provided.

**A** NEW CAMERA no bulkier than the standard motion-picture sound camera has been designed around the dissector-multiplier tube for picking up images for transmission by radio. This camera, shown in Figs. A and B, is capable of televiewing any action that the motion picture camera can photograph. Thus, it is possible to bring scenes of any nature to the home by means of television. The camera complete weighs only 75 pounds, the over-all dimensions of the camera box being only 10 x 12 x 15 ins. long!

The exciting oscillator and the head amplifier both use the new "acorn" (type 955) tubes so as to take up very

## THE DESIGN OF MODERN TEST EQUIPMENT

The conclusion of this interesting series of articles on the design of testing equipment for the Service Man.

SAMUEL C. MILBOURNE Part V

**B**Y HAVING each tube element controlled by a push-button switch, any element of any tube can be tested, separately, or any number of the elements can be tested in combinations, at the discretion of the user, so that the diode elements of full-wave detector tubes, or the plates of full-wave rectifier tubes, can be compared, separately. The flexibility of the elemental switching arrangement, combined with the fundamental circuit features described in the preceding paragraph, enables (1) complete "quality" tests, (2) reliable "leakage" tests between any two elements and, (3) "open-circuit" tests of any element, of all radio receiving types of tubes, with adequate provisions for probable future tube developments.

### FILAMENT RETURN SELECTOR SWITCH

By reference to Fig. 8A, we see a basic filament supply circuit but showing only the 7 and 8-hole sockets. The complete circuit provides for 5 sockets, ranging from 4 to 8 contacts per socket,

connected in parallel, with the connections to the 8-hole socket connected through a circuit-breaking "Filament Return Selector" switch, as shown in Fig. 8A. In order for us to better understand the purpose of this switch, it may be helpful for us to briefly review the evolution of tube pin terminal arrangements, as related to the application of filament or heater potentials.

For a number of years, the design of tube testing devices presented no serious problem insofar as the application of filament or heater potentials was concerned. This was because the filament pins of all popular types of tubes, prior to the advent of the new octal tubes, were adjacent to each other, usually larger than the other pins, and served as the "guide" pins, so that one of the filament contacts of the tester sockets could be connected directly to the "Common" terminal of the filament winding of the tester transformer, and the other filament contact of the sockets could be connected directly to the movable con-

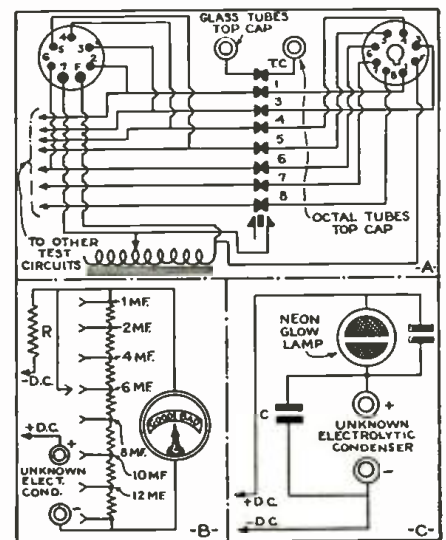

Fig. 8. Parts of the individual tube element tester.

tact of a tap switch which enabled a selection of any required filament potential supplied by the transformer through the tap switch.

With the advent of the octal tube types, tube engineers have abandoned the idea of having the filament or heater pins adjacent to each other, and instead of using the filament or heater pins as guide pins, a large-keyed bakelite locator pin is used in the center of the tube base of octal tubes and the

(Continued on page 111)

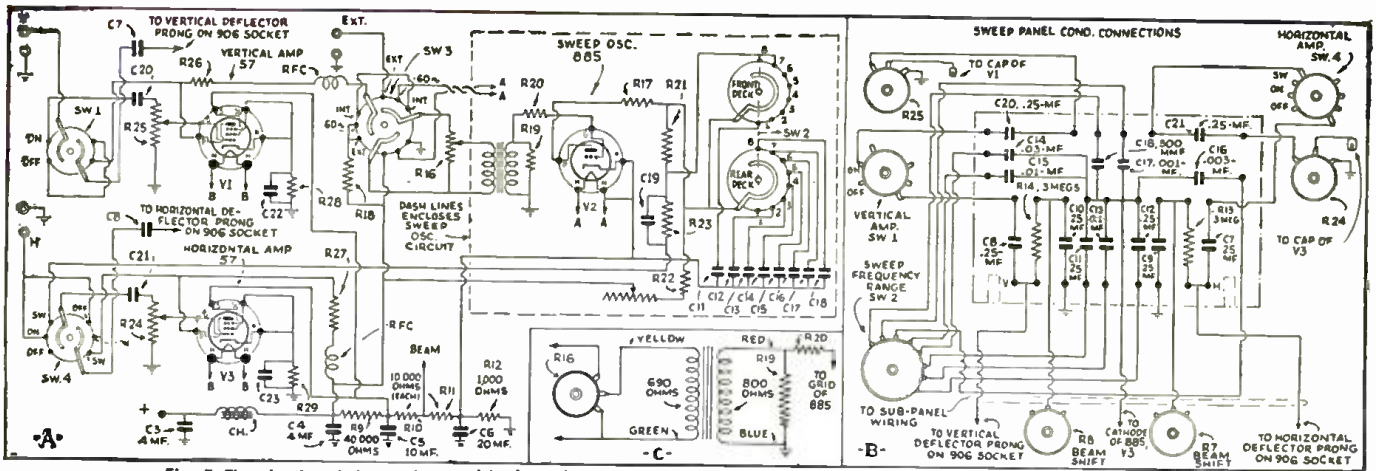

Fig. 7. The circuits of the vertical and horizontal sweep circuits, with details of the sweep panel condenser connections.

# HOW TO MAKE AN OSCILLOSCOPE

CHARLES SICURANZA

## PART II—SWEEP CIRCUITS

IN LAST MONTH'S issue of *Radio-Craft*, we described the construction and elementary operation of a simple cathode-ray oscilloscope. We are now ready to add a wide-range sweep oscillator to the unit. The schematic is given in Fig. 7.

Its primary use in the cathode-ray oscilloscope is to move the luminous spot across the screen at a definite time rate, which permits the vertical voltage under test to be spread across the screen.

The sweep-oscillator circuit is built around the RCA 885 grid-controlled gas triode. This tube is ideally suited for the generation of the saw-tooth wave which is required.

The range of frequencies generated extends from 10 cycles per second, up to approximately 18,000 cycles per second. With 5 cycles of signal voltage on the screen of the 906, it is possible to study waveforms directly up to about 90,000 cycles.

The constants of the circuit are such, that the only part of the sweep output voltage used is the linear portion of each charging cycle. The circuit is stabilized against inherent drift by the fixed bias and grid suppressor method.

The sweep voltage mentioned above, however, is now of insufficient amplitude to swing the electron beam across the screen of the 906. Therefore, an amplifier is used to increase the sweep voltage amplitude. This amplifier is always on, but its input and output circuits may be switched to "ON," "OFF" or "SWEEP."

The various controls and switches associated with the sweep oscillator are used for the purpose of selecting the various frequencies, controlling the output, synchronizing the input voltage and locking the image on the screen.

A complete list of the parts required is given later. We will refer to the list from time to time as we proceed with the discussion.

A cathode-ray oscillograph without any sweep circuit has a definitely limited field of application, as far as the radio servicing branch of the industry is concerned. We mean to emphasize the fact that the addition of the sweep circuit is of vital importance to the utility of the instrument as a whole. It follows, therefore, that the more knowledge relating to sweep circuits the reader has, the better equipped he is to cope with problems arising from operation and interpretation of signal images.

In the meantime, for the prospective builder who may not care to delve into the design considerations of sweep oscillators, we will give a mechanical analogy which, we hope, will at least give him a rough idea of the function of sweep circuits in general.

We will assume that a gallon capacity pail is to be filled to the top with water. This requires, we will say, 15 seconds.

The vertical and horizontal sweep circuits, including the saw-tooth oscillator and amplifier for the horizontal sweep, are described, including a description of the sweep action.

When the pail is full we turn it upside down and empty it completely in 1 second. Electrically, this would represent 1 cycle of the saw-tooth wave. The gallon pail represents a condenser which is being charged with current. When the condenser is fully charged (assume it has taken 15 seconds) it discharges in 1 second.

However, this is not all that happens. To continue with the mechanical analogy, assume that the gallon pail is exactly 1 ft. deep. When it is empty, the water pouring in has to travel 12 ins. to the bottom. As the pail fills, the distance becomes less and less until it reaches the top, whereupon it is emptied in 1 second as before. Now, we have established both the time and the distance, representing frequency and amplitude. If we cut the pail to a depth of 6 ins., it would require only 7½ seconds to fill it up and the

(Continued on page 114)

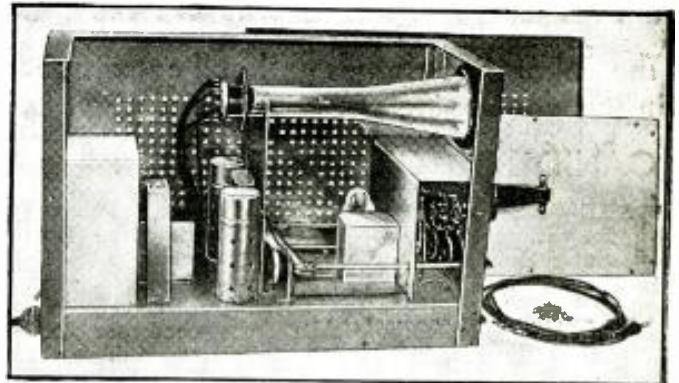

Fig. C. A side view with shields removed.

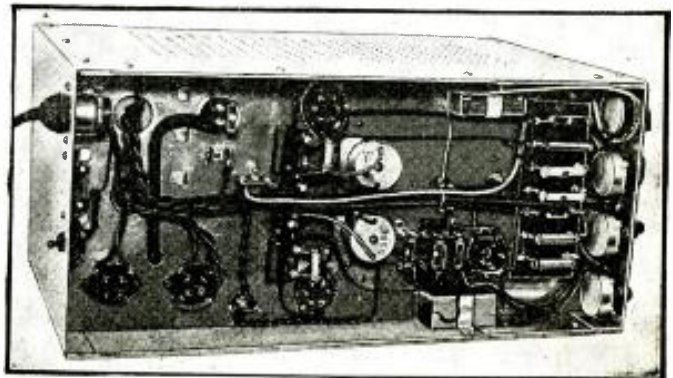

Fig. D. Under-chassis view showing positions of parts.

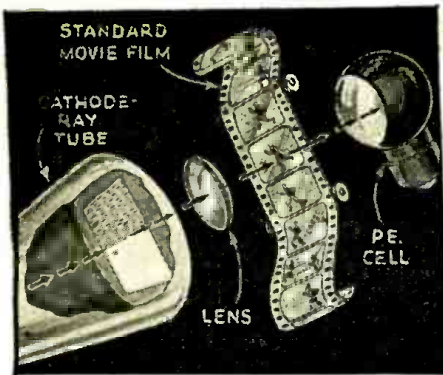

Fig. 1. The method of scanning the film.

IN THE modern television receivers being used in Europe for reproducing television pictures, mechanical scanning methods have been replaced almost entirely by the cathode-ray tube; but for transmitting purposes mechanical systems are still in use, the most common of which is the Nipkow disc with holes on a concentric (or completely closed) circle.

Von Ardenne, Berlin, in 1931 suggested that the scanning of films in the transmitting system should be made with cathode-rays. Meanwhile in America, V. K. Zworykin (R.C.A.) and P. T. Farnsworth have developed the well-known electronic cameras.

It is v. Ardenne's opinion that aside from "real" television, which transmits natural scenes as they occur, films will permanently remain of importance as a means of storing scenes. (The truth

# A CATHODE-RAY FILM SCANNER

Manfred von Ardenne's newest method of film scanning utilizes a 25,000-volt cathode-ray tube with high-intensity spot. Reported from Germany exclusively to RADIO-CRAFT, by Dr. Stager.

## A. STAGER

of this assertion is borne out by Mr. Don Lee's experiences, as reported in this issue.—*Editor*) Happenings of general interest usually take place during the daytime. For making them accessible to the owner of a television receiving set, who wants to enjoy it in his

evening's spare time, it is necessary to have available an apparatus for scanning the films with several hundred lines. Mechanical devices cannot operate with sufficient accuracy. Perfect precision can be obtained only by the  
(Continued on page 115)

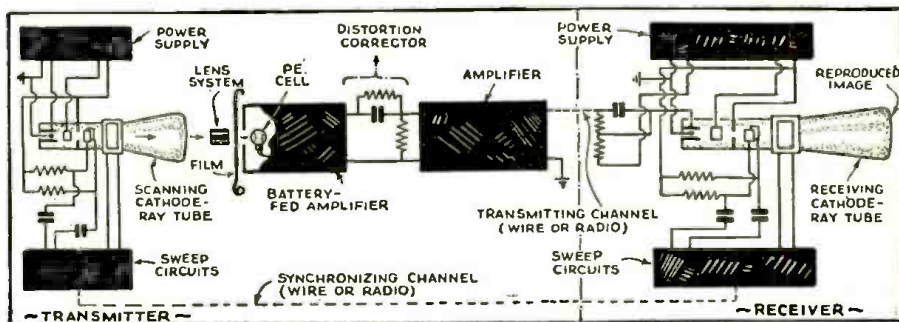

Fig. 2. A block diagram of the transmitting and receiving systems.

# MAKING A PRECISION ALIGNING UNIT

The calibrating details and coil construction are described in this concluding part. A list of parts is included.

## CANIO MAGGIO PART III

THE ONLY accessory required for the calibration of the signal generator described in the preceding issue of *Radio-Craft* is a T.R.F. receiver, consisting of one or two R.F. stages loosely-coupled and free from circuit oscillation (range 500 to 1,500 kc.), which is used to calibrate the low frequencies (100 to 1,500 kc.). The remaining frequencies are calibrated with a short-wave receiver.

The procedure in calibrating the signal generator is simple, and is easily mastered.

Couple the signal generator (service oscillator) to the T.R.F. receiver. Set the tuning condenser of the service oscillator at maximum capacity and modulate the carrier with any one of the 10 generated audio frequencies.

The receiver is then tuned to the low-frequency end of the scale until a note is heard, as 600 kc., then the receiver is retuned to a higher frequency, without touching the service oscillator, until

a note is heard again, as 700 kc. The difference (in this case) is 100 kc., which is the fundamental frequency of the signal generator.

Repeat the process with the tuning condenser at minimum capacity, so as to establish the two ends of the band. In some cases it is necessary to increase or decrease the service oscillator inductance so as to cover the full width of the band.

To calibrate the band after correction, set the service oscillator condenser at maximum; "zero beat" the service oscillator signal with a broadcast station carrier (600 kc.); vary the receiver dial until it indicates 700 kc., zero-beat, or beat with 710 kc. (WOR in the New York area). The service oscillator frequency is then 100 kc., which is to be marked on a sheet of graph paper.

Retune the receiver to 600 kc., and vary the service oscillator dial until another note is heard. The next logical

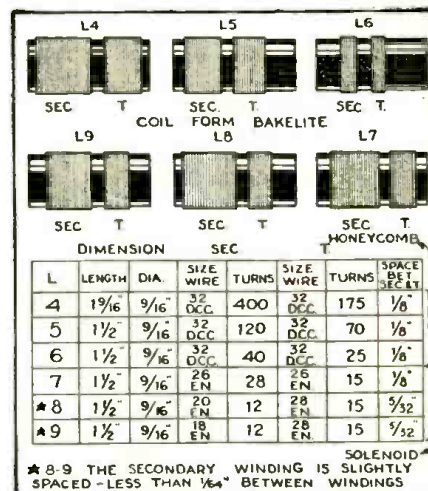

Coil details for the 6 bands.

note that can be heard at 600 kc., after the 100 kc., is 120 kc. The 5th harmonic of 120 kc. is 600 kc. Mark this point on the graph paper. *Don't retune the receiver.*

The next note is 150 kc., the 4th harmonic of which is 600 kc.; the next is 200 kc., the 3rd harmonic of which is 600 kc.; next is 300 kc., the 2nd harmonic of which is 600 kc.

Various stations are used so as to obtain as many marks as possible on the graph paper before drawing the curve.  
(Continued on page 116)



A department in which the reader may exchange thoughts and ideas with other readers of RADIO-CRAFT.

# READERS' DEPARTMENT

## ELIMINATING TUNABLE HUM

Simcoe, Ontario:

In a set that I constructed, I experienced a rather unusual type of hum. This hum was much worse with a straight "L" type antenna, than with the transposed-feeder doublet type; it peaked at WGY, and was audible above and below this frequency as far as WABC and WJZ.

It was only audible when stations within this frequency range were tuned in, faded in strength with the station carrier, and was somewhat drowned out by the modulation. There was no hum when the station was off the air, and the stronger the carrier, the worse the hum. I did not experience it on any other frequency, either broadcast or short wave.

The cure was simple, a capacity-type filter across the A.C. line input, with the center of the condensers grounded, as shown in Fig. 1, did the trick. I concluded that it was A.C. hum picked up from the line or power pack by the portion of the antenna or lead-in close to the set, and this hum was superimposed on the carrier of the transmitter, but why at only one frequency I can't figure out. I would be glad to know what you or any of the readers of *Radio-Craft* think is the correct explanation.

WM. A. WALLACE

It is generally conceded by engineers that this trouble is caused by R.F. pick-up by the A.C. power line, which passes R.F. (which is further modulated by the 60-cycle current) into the receiver. The filter in the power pack is not effective at R.F., so it does not remove this component. The R.F. appears in the plate circuit of the detector tube but does not become audible until a carrier is tuned-in through the grid circuit of the detector, at which time the unwanted hum modulates the incoming signal. It only appears on parts of the band because the line which picks up the complex interfering currents happens to be tuned to that part of the band. The remedy is to bypass the R.F. pick-up to ground before it enters the set. A condenser of about 0.01-mf. is sufficient and you will see such a condenser in the power supply of almost any receiver now made, including the A.C.-D.C. jobs. An electrostatic shield in the power transformer accomplishes the same purpose, by preventing capacitive coupling between the primary and the secondaries, and thus preventing the transfer of the unwanted R.F.

## CONVERTING AN A.K.—70Q

Kellerton, Iowa:

I have an idea which I have been using that you might be able to pass along through your magazine to other Service Men.

Recently I converted an A.K.—70Q radio for use with 2 V. tubes. When I got the job done the tone of the set was very poor. This set had push-pull type 71A tubes in the output, and so I changed to push-pull 31-type tubes. The load impedance for the 71As is approximately 1,000 ohms less than that of the 31s. I tried various means of bypassing and other tricks to bring the tone up to normal, but with no success. As a last chance I put a 2,000 ohm resistor in each plate lead as shown in Fig. 2. This helped the tone considerably, but the speaker still had a rattle at high volume levels. The only way I could stop this was to cut the plate voltage of the R.F. tubes to 67½ V. and the S.-G. to 45 V. Even at these low voltages I lost no sensitivity.

I am a newsstand reader of your magazine and think it is the best ever.

DALE L. COFFMAN

Thanks very much for the tip—and the bouquet.

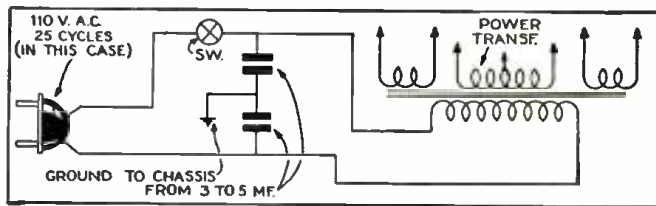

Fig. 1. Curing tunable hum. Note that much smaller condensers will often do as well.

## "ONE OF THE FINEST SERVICE SHOPS IN THE UNITED KINGDOM"

An English firm, "Solectric Limited," answered the plea of Mr. Nissar in the Readers Dept., February *Radio-Craft*, with the following letter, of which they kindly sent us a copy. We hope the needs of Mr. Nissar are now well taken care of.

"Being official distributors for the Sparton radio receivers, we are very interested in your letter published in the current issue of *Radio-Craft* and would like to thank you for your mention of Sparton.

"We take this opportunity of enclosing leaflets describing the full range of Sparton Receivers, of which we carry very considerable stocks.

"We note your remarks regarding the difficulty you have experienced in getting service on some American receivers and would state that we have one of the finest equipped service shops in the United Kingdom and its facilities are used by many of our friends abroad. Should you be desirous of having any technical information or schematic diagrams of any of our receivers, we shall be very happy to be of service to you."

We believe this letter speaks for itself.

## EMERGENCY IMPROVEMENT FOR A.C. - D.C. RECEIVERS

Oakdale, Iowa:

I have been a constant reader of *Radio-Craft* for the past 5 years and enjoy it very much, especially the Operating Notes.

I have a kink here that may prove beneficial to some Service Men. In Oakdale we have 110 V. D.C. power and, as usual with the transmission of D.C., by the time the remote residences are powered, the voltage has dropped as low as 70 to 75 V. in some cases. Due to the fact that 110 V. D.C. sets are rather scarce, there are a great number of small A.C.-D.C. sets here, and because of the lowered voltage and losses in the rectifier and filter system, a potential of only about 40 or 50 V. is available for the plates. This is not enough for satisfactory operation and so we have many complaints. My remedy for this situation is to shunt out the rectifier and filter, or if the customer wants to use the receiver on A.C. at some time, put in a simple switch on the back cover.

(Continued on page 117)

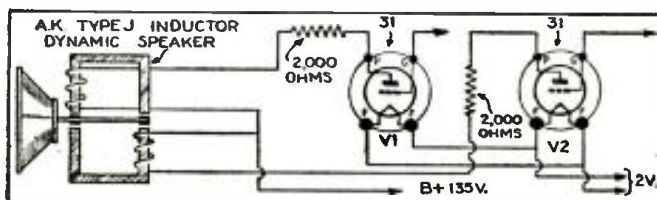

Fig. 2. Improving the tone quality in a set that was rebuilt with 2 V. tubes.

# THE LATEST RADIO EQUIPMENT



"Magic lion" tuning unit. (1073)

## THE MAGIC LION (1073)

THIS unit consists of a cathode-ray tuning tube housed in a bronze-finished metal housing, which may be set upon the receiver cabinet or in any convenient place near the set. It may be used with any set whether it uses 2½- or 6-V. tubes, or whether it incorporates A.V.C. (states the manufacturer). The unit is simple to install since only 5 wires need be connected and there are no holes to drill.

## IRON-CORE WAVETRAPH (1074)

INTERFERENCE which enters the receiver through the antenna lead and which is tuned to about the frequency of the I.F. stage of the receiver may be eliminated by the use of this adjustable trap which tunes from 440 to 480 kc. The tuning is accomplished by means of the small screw projecting through the top of the can, the screw acting to move the polyiron core inside of the coil. The small size enables it to be used in even the so-called "cigar box" sets.



Iron-core wave trap. (1074)

## DOUBLE-RIBBON MIKE (1075)

TWO RIBBONS are used in this unit, with the center connection grounded. This results in lack of sensitivity to stray magnetic fields, a great advantage in a microphone of this type. The use of 2 ribbons also doubles the sensitivity of the unit. A magnet of cobalt steel gives a field 3 times as strong as would ordinary steel. The case is open only at the front, thus making the unit uni-directional. The sensitivity is -90 db., and the output is down only 2 db. from 30 to 10,000 cycles.



A double-ribbon microphone. (1075)

## PROFESSIONAL RECORDER (1076)

(Universal Microphone Co.)

THIS latest recording machine incorporates several new developments. It may be used for cutting either towards the rim or the center of the record, and has timing bar with speed regulated at 90, 110 or 130 lines per in. Other improvements include a new motor, a countershaft that permits instantaneous changing of any speed or lines per inch desired, a more massive turntable,

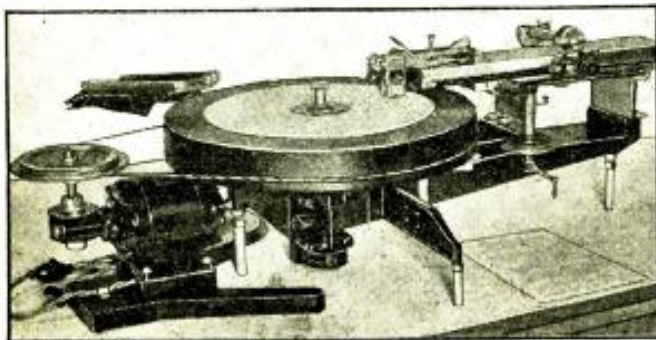

The latest in professional recording machines which has many new features, among which are a floating head, special countershaft and heavier table. (1076)

Name and address of any manufacturer will be sent on receipt of a self-addressed, stamped envelope. Kindly give (number) in above description of device.

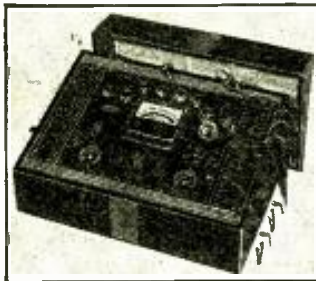

Multi-meter and tube tester. (1077)

and a new floating head which has adjustments for changing both the vertical and lateral angularity. Tempered steel guides provide accuracy of cutting within 1/10,000 of an inch.

## "POWER OUTPUT TUBE" TESTER (1077)

(Triplet Electrical Inst. Co.)

IN ADDITION to a very complete series of tube tests, this equipment may be used as a D.C. voltmeter and milliammeter, ohmmeter, A.C. voltmeter, condenser tester, decibel meter and impedance tester! It is housed in an oak case with sloping panel and may be used for either counter or portable service. Tubes are tested for worth by rating their amplification and also by making neon short tests.

## ACOUSTICAL LABYRINTH (1078)

WHILE this unit is not available for use except in the receiver for which it was designed, it is shown here because of its general interest. The labyrinth (an improvement over the earlier model described in *Radio-Craft*) is constructed of special acoustic material, and takes the place of the usual box-like cavity in the receiver cabinet. Use of this device is said to cause natural tone and to extend the bass note reproduction at the same time removing the boomy type of response sometimes associated with the console design of cabinet.

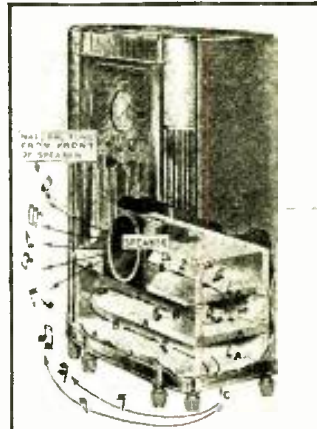

Acoustical labyrinth. (1078)

## ALL-PURPOSE AMPLIFIER (1079)

(Remington Radio & Elec. Corp.)

AN OVERALL gain of 129 db. with a power output of 40 W. is possible with this high-fidelity amplifier, at which power the battery drain is only 14 A. High voltage is supplied by dynamotors when operating on 6 V. To conserve battery power, a switch is provided to cut out one of the 2 dynamotors and two of the four 79-type output tubes, the output then being 20 W. Four input channels with individual controls are available for high- and low-impedance microphones and phono pickups. Operation on 110 V.A.C. from a built-in power supply is also possible by the throw of a switch. Tubes used are: 7-79s, 2-6A6s. Two universal impedance output transformers permit any speaker combinations.

(Continued on page 118)

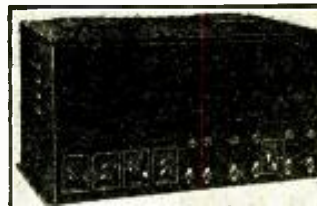

All-purpose amplifier. (1079)

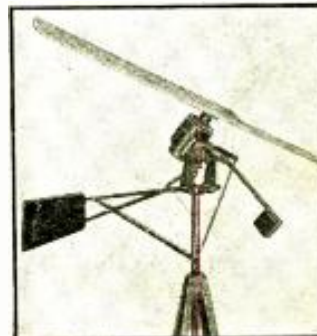

A 32-V. power plant. (1080)

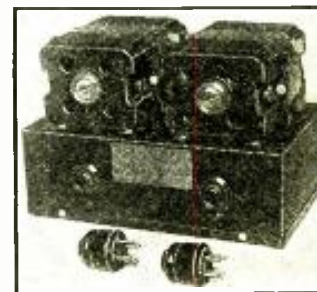

Mobile dual power supply. (1082)



Auto P.A. system which uses crystal microphone and has 20-W. output. (1081)

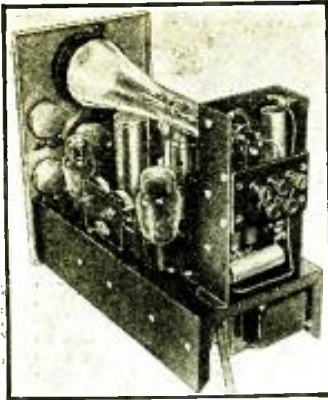

Interior of compact oscilloscope. (1097)

### COMPACT OSCILLOSCOPE (1089)

(Allen B. Dumont Labs., Inc.)

A NEW oscilloscope having many novel and valuable features, including exceptionally low weight and small dimensions, has just been introduced for Service Men, engineers, etc.

The unit, which is extremely simple when compared to equivalent units made by other manufacturers, utilizes a 3-in., high-vacuum oscilloscope tube and is complete with the sweep oscillator, amplifier, etc., needed for A.C. and D.C. analysis work. The instrument is approximately half as heavy as equivalent units because of the unusual circuit employed.

Two type 80 tubes in a voltage-doubling circuit supply the high voltage of approximately 1,000 V. for the "gun" of the oscilloscope tube, and the various intermediate voltages required by the amplifier and oscillator. Because of this voltage-doubling circuit, the high-voltage transformer supplies only 550 V. instead of the usual 1,100 and is consequently much smaller (and therefore lighter); thus, it has a smaller field, thereby reducing the possibility of picking up transient power line wave formations which might modulate the cathode stream. Also due to this unusual circuit, a heavy filter choke is not required since the power supply voltages can be effectively filtered by the use of resistors and condensers.

A basically new sweep circuit is used in this unit having advantages over previous circuits. In this sweep oscillator the discharge of a condenser rather than the charge of a condenser is used, in conjunction with the usual thyratron-tube oscillator, for the linear sweep circuit. This together with a pentode which is used as a constant-current limiting device, enables waves from 10 cycles to 1,000,000 cycles per second to be observed and synchronized.

The sweep amplifier employs a type 57 tube in a circuit utilizing principles recently evolved for tele-

vision amplifiers, and as a result of this advanced design the amplifier provides a voltage gain of 100 between the frequencies of 10 and 100,000 cycles with a gradual tapering to a gain of 25 at 1,000,000 cycles. Because of this unusual sweep oscillator and amplifier it is possible to analyze frequencies well up into the radio frequency spectrum. By the use of 4 or 5 patterns, it is possible to directly analyze frequencies as high as 5 or 6 megacycles!

Due to the wide frequency range of the amplifier a number of switches have been eliminated, thus reducing coupling and capacity effects between circuits — which greatly simplifies the operation of the unit without sacrificing flexibility. A glance at the photos of the unit shows how few controls are required for all practical work.

Five terminals with jumpers have been provided on the back of the unit which permit signals or voltages to be applied directly to the deflection plates without any intermediate amplifier, condenser or other device. This permits the application of direct potentials to the deflector plates when desired. By placing the binding posts at the back, close to the oscilloscope tube socket, the usual long, shielded leads to the front panel are eliminated making the unit more stable and eliminating any possibility of interlocking of controls.

The tube used in this unit, as mentioned above has a 3-in. screen. The sensitivity is 0.38-mm. per volt or in more commonly-used terms, the tube has a sensitivity of 75 V. per inch with a signal applied directly to the deflection plates. When the full sensitivity of the amplifier is utilized this sensitivity increases to 0.75-V. per inch. The unusual features of this unit together with its small size (11 x 6½ x 13 ins. long) and light weight (about 15 lbs.) make it an ideal unit for both laboratory and portable use.

### AN ADVANCED COMMUNICATION RECEIVER (1090)

(Hammerlund Mfg. Co.)

THE NEWEST Hammerlund development—the "Super Pro"—is a 16 tube amateur-professional superheterodyne receiver. Views of the instrument appear below.

It consists of 2 stages of tuned radio frequency amplification using 2 6D6s; a first-detector or mixer using a 6A7; a high-frequency oscillator using a 6C6, electron coupled to the first-detector; 3 stages of 465 kc. I.F. amplification with 6D6s; a combination 4th I.F. stage and diode 2nd detector with a 6B7; an amplified A.V.C. system with a 6B7; a low-frequency beat oscillator (operating at intermediate frequency) using a 6C6, and 3 stages of A.F. amplification; these divide up in the following way;— a 76 as

a resistance-coupled A.F.; a 42 as a class A driver, and 2 42s in class AB or A prime push-pull audio output.

A separate power supply supplies plate voltage, grid bias voltage, speaker field current and heating current.

A 5Z3 is used as a plate voltage rectifier and a 1V as a grid voltage rectifier.

Although primarily designed for complete A.C. operation, it is also possible to use storage "A" battery and dry "B" and "C" batteries by simply changing the cable strip. No change in the receiver is necessary for this work. The range of the receiver is from 540 kc. to 20 megacycles, divided into 5 bands and controlled by a special, 5-band silver-plated switch.

The features of the set are numerous. For instance, there is an electrostatically-shielded input; the 5-band eccentric cam switch; 4 air-tuned I.F. transformers; continuously-variable selectivity; visible tuning meter; (illuminated) tuning dial accurately-calibrated in megacycles and kilocycles; (illuminated) band-spread tuning dial; R.F., I.F. and A.F. gain controls; variable beat oscillator control; tone control; speaker-phone switch; send-receive switch; A.V.C.-manual switch; CW-modulation switch, etc.

As mentioned above, the receiver incorporates a most unusual switching arrangement (illustrated in the group of photos shown below). The switch utilizes an entirely new design and was decided upon after endless hours of research, for it proved to be absolutely noiseless, fool-proof, and exceedingly effective throughout the entire band of frequencies covered by the receiver.

A well-designed superheterodyne is, in reality, a combination of two distinct receivers of specific design which combined together offer an unusually efficient radio receiving system. The first part of such a system is connected to the receiving antenna and selects and amplifies the incoming signal, delivering it to the first-detector or mixer where it is heterodyned by the local high-frequency oscillator to produce a new frequency called the intermediate frequency or "I.F."

The second part of this system is a complete and highly efficient radio receiver with fixed tuning, which responds to signals of the I.F. produced by the first unit. The tuning and all other adjustments on the set are exactly fixed in the laboratory. Therefore, it is obvious that its performance can be more exactly controlled than in the case of the receiver which must be tunable over a relatively wide frequency range. Generally speaking, most of the gain and selectivity of the entire receiving system are obtained from this fixed tuning unit. For instance, in the "super Pro" set here illustrated this I.F. amplifier consists of 10 tuned circuits in

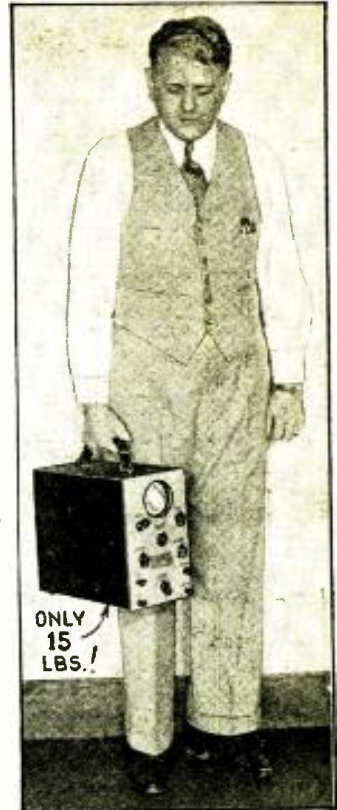

ONLY 15 LBS.!

This instrument carries easily! (1089)

cascade—certainly an impractical number to control with variable tuning. The mechanical or structural separation of these two parts has therefore been carried out almost as completely as their electrical or functional separation.

The main tuning condenser has 4 sections of 180 mmf. each. The rotor plates are the "midline" type which gives a uniform frequency range for the 2 to 1 tuning range. The band-spread condenser, which is mechanically identical to the main tuning condenser, is divided into 4 main sections. These sections have their separate rotors and stators—or to be exact, 3 such units for each section; this gives a total of, actually, 12 condensers in the entire band-spread unit. In this way, a wide degree of band-spread action can be secured in each of the 3 high-frequency bands.

The tuning coils are mounted on individual isolantite bases which are in turn secured to shield partitions. There are 25 coils in all, or 5 for each of the 5 bands. In each band the input circuit consists of 2 coils—an antenna or primary coil, and a grid or secondary coil. These 2 coils are effectively shielded from each other electrostatically by a Faraday screen placed between

(Continued on page 118)

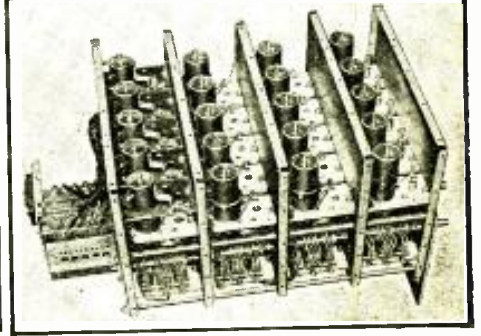
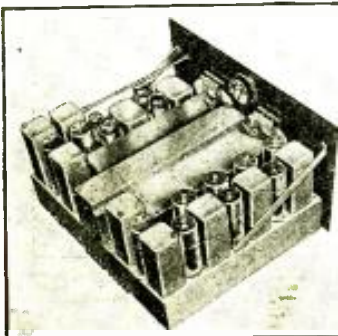

Interior of an advanced "all-wave" receiver. The panel view is in center, while at right is the ultra efficient coil system. (1090)

## ZENITH MODEL 7M91 7-TUBE "SAFETY" AUTO SUPERHETERODYNE

(Features: class B output; sensitivity switch; antenna filter; external speakers.)

Below is a table of tube voltages for this set taken with 5.8 V. at the switch:

Tube	Cath.	C.-G.	S.-G.	Plate
V1	5.2	0	100	250
V2	5.2	0	100	250
V3	6.7	0	100	240
V4	1.6	0	—	145
V5	8.2	0	—	240
V6	0	0	—	250
V7	250	—	—	A.C.

These measurements hold true with antenna disconnected and meter of 1,000 ohms per volt. The total current consumed is 8.2 A.

at the maximum power output of 9 W. The sensitivity is "1 microvolt at 1 W. output," states the manufacturer. Since the set has no speaker in the case it is furnished with sockets at one end of the case, so that any combination of 1 or 2 speakers may be used. Note that if only one speaker is used, the capping plug must be in the unused socket. For alignment of the I.F. stage, the test oscillator should be connected to the cap of V2 and ground. An output meter may be connected across the primary of the output transformer. The adjustments of the trimmers on the I.F. transformers should be repeated several times

to insure the most exact setting. Then connect the test oscillator to the antenna lead and set its dial at 1,400 kc. Rotate the gang condenser control 1/4 turns from minimum setting. At this position 8 teeth on the tuning gear will be visible past the gear bracket. Adjust the oscillator, detector and antenna trimmers in that order to get the point of greatest output. Set the service oscillator at 600 kc. and rotate the receiver tuning condenser to tune in this signal. Move the gang condenser back and forth slightly while adjusting the oscillator padding condenser to get the greatest reading on the output meter.

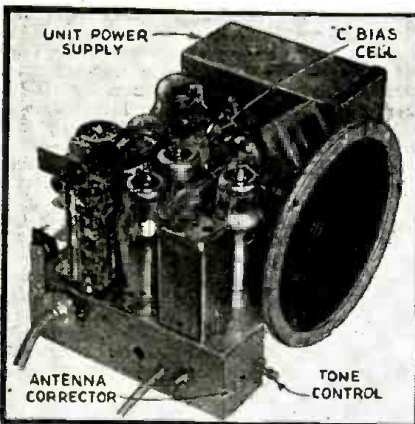
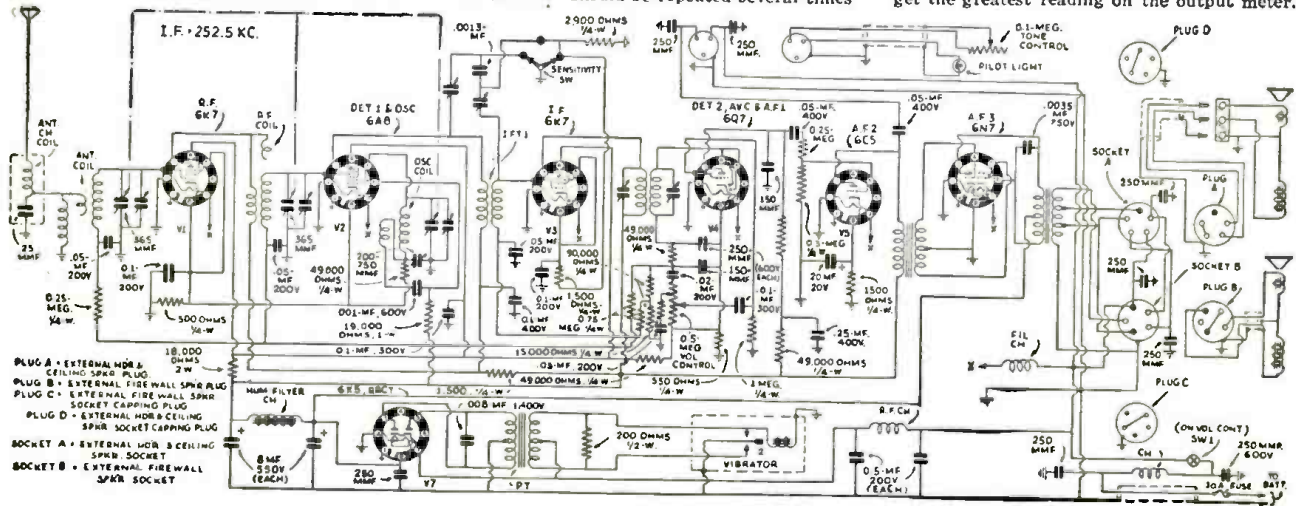

## HOWARD 6-TUBE SERIES I AUTO SUPERHET.

(Features: iron-core coils; antenna adjuster; no suppressors needed.)

Voltages for this receiver are shown in the following tabulation:

Tube	Plate	Cathode	S.-G.
V1	250	2.6	100
V2	250	3.75	100
V3	250	7.0	100
V4	120	0	—
V5	100	0	—
V6	235	16	250

These voltages are read from chassis with 6 V. input to the receiver.

When installing this receiver it may be found that the pointer is not at the correct point on the dial. This may be corrected by

inserting a small screwdriver in the screw that is on the rear of the remote control in the center. This screw turns the pointer independently. When the set has been placed in a car, tune it to a station around 600 kc. on the dial and adjust the antenna balancing screw which is on the front of the cabinet, for maximum signal. If a signal generator is used for this adjustment it should not be attached to the set antenna lead but rather allowed to operate the receiver as a regular transmitter would. It may be placed a few feet from the car and a short piece of wire attached to it to act as an antenna if found necessary.

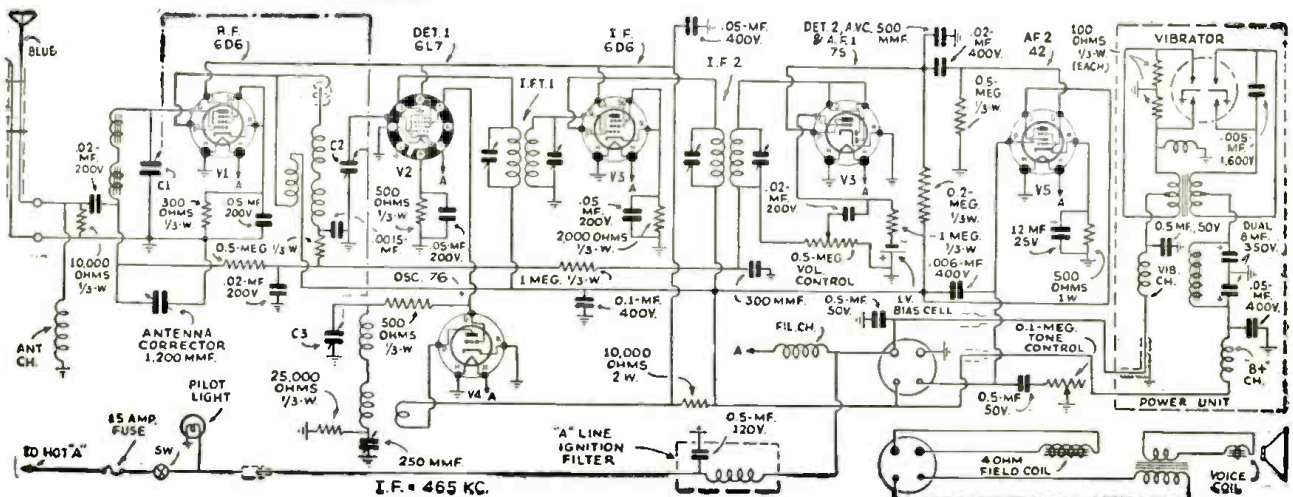

RCA VICTOR MODEL 236-B 7-TUBE BATTERY SUPERHET. RECEIVER

(Features: Permanent-magnet dynamic; class B; separate A.V.C. tube; tuning range, 540 to 1,720 kc.; max. output, 2.2 W.)

The operating voltages for this receiver are given on the small drawing. They are those obtained when the receiver is in actual operation, but do not take into account the inaccuracies caused by the current drain of the meter. The volume control should be at maximum with no signal input and all batteries in good condition. Two "A" battery leads are provided, one for use with a 2-V. storage cell and the other with a 2.5-V. air cell. To align, connect antenna and ground leads to ground. Connect test oscillator between ground and C.G. of V1. Adjust the I.F. transformers. Then connect test oscillator to antenna and ground leads, and set it at 1,720 kc., then adjust C1 and C2. Shift

test oscillator to 600 kc. and adjust C3 for best results. Rock the receiver tuning condenser slightly while doing this. Then repeat the 1,720 kc. adjustment. Be sure, before starting alignment, that the tuning dial reads 540 when the condenser is fully meshed. The output of the test oscillator should always be kept as low as possible during all these adjustments, by means of the attenuator on the instrument. The total "A" battery current is 0.68-A. and the maximum "B" current is 21 ma. The maximum undistorted output is 1.2 W., and the maximum output 2.2 W. A fuse is provided in the "B" battery lead and this should be checked first if trouble develops.

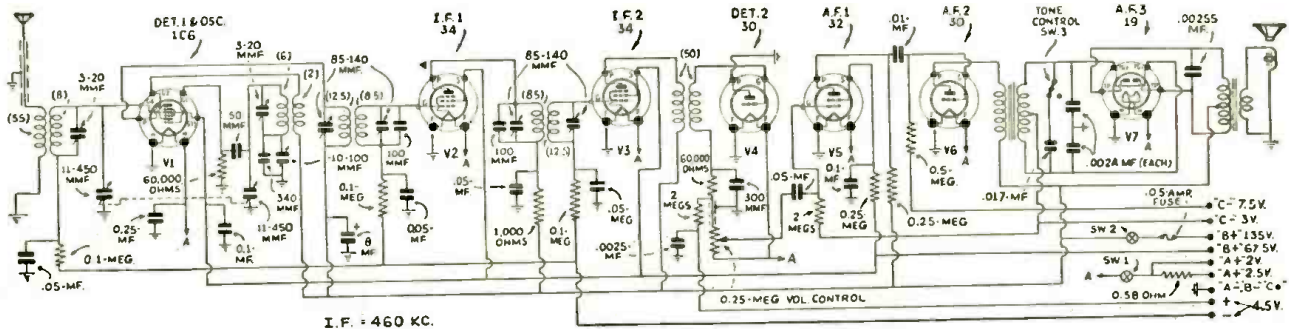
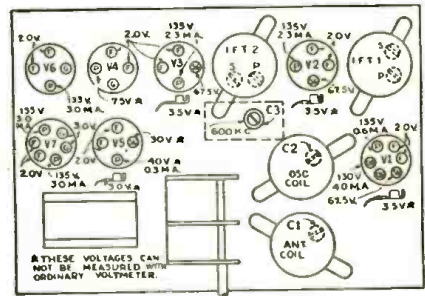

MIDWEST MODEL 14-37 14-TUBE ALL-WAVE SUPERHET.

(Features: 5 bands; tuning tube; push-pull parallel output stage; hum-bucking coil; separate oscillator.)

Voltages are as in the following table:

Tube	Plate	S.-G.	Sup.-G.	Cath.
V1	245	110	0	0
V2	220	110	3	3
V3	220	110	0	0
V4	220	110	0	0
V5	0	—	—	0
V6	100	—	—	3
V7	205	205	0	30
V8	150	—	—	3
V9	A.C.	—	—	0
V10	A.C.	—	—	375
V11-V14	300	300	0	0

connected between grid of V2 and ground and with tube V8 out of set. Align "E" band at 325 and 135 kc.; "A" band at 1,490 and 550 kc.; "L" band at 3.8 and 1.6 mc.; "M" band at 11.5 mc.; "H" band at 28 mc. Always align the lowest frequency last in those cases where 2 frequencies are given for each band. A good all-wave test oscillator is absolutely necessary, to adjust the receiver to the highest efficiency. An output meter must also be used. For all alignment except the I.F., the test oscillator leads are connected to antenna and ground. After each preliminary adjustment of a band the whole thing should be gone over to secure the best possible setting for all trimmers of that band.

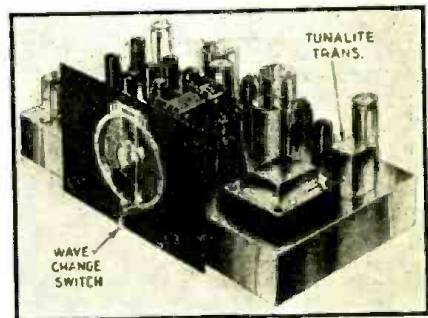

Above ratings are with no signal input. Align the I.F. transformers with generator

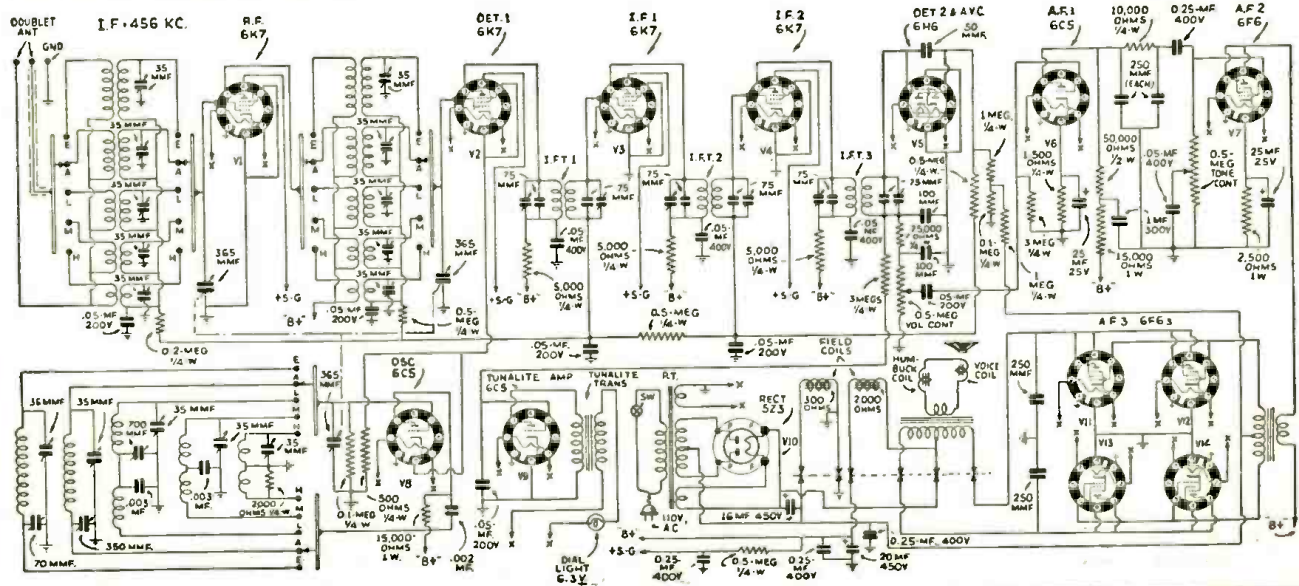

# OFFICIAL RADIO SERVICE MEN'S ASSOCIATION, INC.

A department devoted to members and those interested in the Official Radio Service Men's Association. It is the medium for exchanging ideas, kinks, gossip and notes of interest to Service Men, or others interested in servicing.

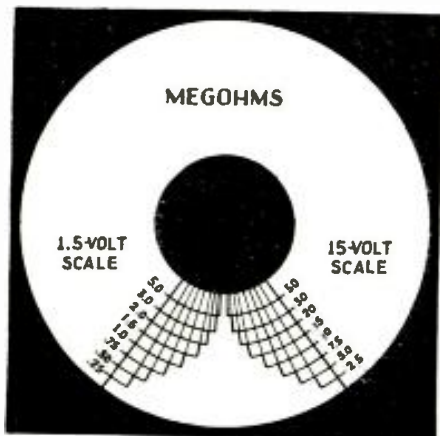

Fig. 1. Here is a reproduction of the dial used on Mr. Nicholson's "magic eye" leakage tester.

## ADDED DATA ON "MAGIC EYE" LEAKAGE TESTER

RADIO-CRAFT, ORSMA Dept.:

I submit herewith for your information a copy of my reply to inquiries concerning the "magic eye" leakage tester published in March *Radio-Craft*. I have included a copy of the dial used on my own tester. It is perhaps unfortunate that, due to the wide variations in 6E5 tubes, no one calibration is satisfactory for general use.

C. T. NICHOLSON,  
Buffalo, N. Y.

Above is an excerpt of a letter from Mr. Nicholson; the scale is reproduced in Fig. 1. We believe that the information, which follows, will greatly increase the usefulness of this handy equipment.

"Unfortunately the article on the "Cathode-Ray Leakage Tester in March *Radio-Craft* did not contain complete information relative to the calibration of the completed tester.

"The intent of the article was primarily to create interest in the application of the 6E5 to service problems and the application featured was taken as a simple starting point. The construction of the tester should be extremely simple, in fact with the exception of the matter of calibration the only possible source of trouble might be in the actual connections to the 6E5 tube socket (V1 in 'Figure 1 left' at bottom of page 531). Fortunately the schematic diagram shown is correct in all details except that no statement is made to the effect that the connections to the socket are actually as shown when viewed from the bottom of the socket, i. e., in R.M.A. designations, the point TP which is triode plate is socket terminal No. 2; TG or triode control-grid is No. 3; target is No. 4; and K or cathode is No. 5. The heater connections or HH are No. 1 and No. 6.

"The matter of calibration is more difficult because of the wide variations in the characteristics of the 6E5 tube. The best way to calibrate the instrument is with resistors of known value. This is, of course, rather difficult to do with high accuracy but can be done to 5 per cent or so by connecting carbon resistors of known resis-

tance in series to make up the standard resistance. To go into more detail, after the unit has been assembled as specified, the line switch, Sw.2, should be turned on and the unit allowed to heat up for a few seconds. After the 6E5 target is luminous the zero adjustment, R4, should be turned until the dark sector of the target is reduced to a hair-line (posts P1 and P2 should be open, of course).

"A paper ring should be cut to fit over the top of the 6E5 (see Fig. 1). This ring should be covered with a protective celluloid ring after it has been calibrated.

"With switch Sw.1 set for 1.5 V. "E" battery, short-circuit posts P1 and P2 and mark the limits of dark sector on the paper scale. Next remove short-circuit and place a tested 0.25-meg. carbon resistor between P1 and P2. Again mark the limits of the dark sector on the paper dial. Repeat for resistors of 0.5-0.75-1, 1.5, 2, 3 and 5 megs. Usually resistors of more than 1 meg. are not available, in which case use series combinations of resistors, i. e., for 1.5 megs. use a 1 meg. and a 0.5-meg. resistor in series, etc. For the calibration with the "E" battery at 15 volts it is sufficiently accurate to multiply the 1.5 volt calibration by 10."

## "LICENSE THE SERVICE MAN," HE SAYS

RADIO-CRAFT, ORSMA Dept.:

I have been a constant reader of *Radio-Craft* for the past 6 years and from it have taken much valuable information and data regarding radio service.

I have followed quite closely your ORSMA Dept. and aside from a few helpful hints donated by others in the service profession, this department has been of very little help to the Service Man.

Conditions in the service industry are very much the same in all parts of the country and I must say that of all the professions in which a man may venture, the radio service profession, while one of the most widely used, is the least protected, most unrecognized profession

of them all. Doctors, dentists, lawyers, and craftsmen of all kinds have their associations, and unions, and state and government laws to uphold and protect them. In our city an electrician must pass a rigid technical examination and pay a license fee of \$30.00 per year before he is allowed to do electric wiring, and failure to comply with this ordinance subjects a wire man to an imprisonment of 50 days and a fine of \$100.00. Yet anyone between the ages of 10 and 90 years who knows enough to pick up a screwdriver by the right end can and does do radio work.

In your March 1936 issue, I noticed the announcement that the Radio Service profession has been recognized by the American Federation of Labor. Knowing nothing of this organization besides its name, it means practically nothing to me, and I doubt if 25 per cent of your readers saw this particular item at all. So far as I have been able to find out most of all the Leagues and Clubs which have been organized to help radio Service Men have been dues collecting agencies, relieving Service Men of some of their extra change for dues, and in my opinion this procedure has gone quite far enough. I would like to call a vote of every honest, tried and true Service Man to see what percentage would be willing to take a good, tight technical examination and pay a yearly license fee of, say, \$15.00. I would like to see what percentage of these men would be in favor of making this a law, and imposing upon the hacksaw and crowbar mechanics a penalty for operating as a radio Service Man.

Men that have put in 5 or 10 years of their life learning and becoming expert at this profession do not feel justified in having a 14 year old high school boy who has built a 1-tube transmitter and owns a soldering iron, and who has 4 or 5 months radio amateur experience going out and posing as a radio expert among the customers of the experienced man. It is my opinion that the Official Radio Service Men's Association could and would be one of the greatest organizations in the radio industry,

(Continued on page 117)

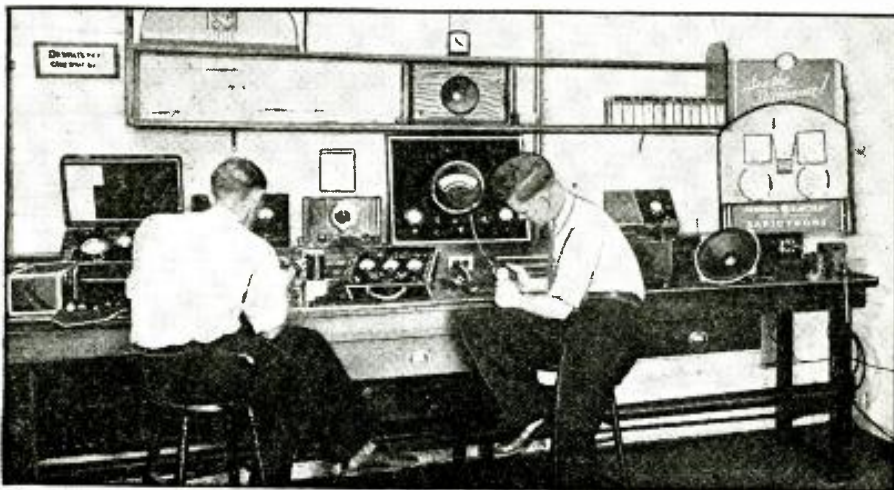

Fig. A. The work bench of the service shop of Brown and Nixon, Toronto, where the slogan is, "Honest Work at Fair Prices." Both partners have long experience in the game. They have built a good deal of the test equipment themselves, including an oscillator, megger, etc.

BELMONT MODEL 522 5-TUBE 2 V. BATTERY SUPERHETERODYNE

(Features: batteries self-contained; pilot indicator; uses only 90 V.; improved speaker; low power drain.)

The voltages for this receiver are shown on the diagram. They are all measured to "B-". The receiver is equipped with a battery rheostat which is on the rear of the chassis. It should be set according to the type of battery being used. For storage battery use it must be turned as far clockwise as possible and left in this position. When the dry type of "A" battery is employed, the pointer must be set as far counterclockwise as possible while still retaining good quality. When the battery is new, this setting will be below 1 on the scale, and the setting will have to be changed from time to time as the battery loses its voltage with use. Note that only 90 V. of "B" voltage is used, the longest type naturally being had with the heavy-duty type of unit. There is no "C" battery

needed, the necessary voltage for bias coming from a drop across a resistor in the high voltage lead. Alignment of the I.F. transformers is made with a 0.1-mf. condenser connected in series with the signal generator lead and the cap of V1. Adjust trimmers C1, C2, C3 and C4. Set test oscillator at 1,720 kc. and connect its output in series with a 200 mmf. condenser to antenna and ground posts. With set tuning condenser at minimum, adjust C5 for resonance. Reset test oscillator to 1,400 kc., tune in on set, and adjust C6. Set test oscillator to 600 kc., move receiver dial to 600 kc. and adjust C7 for highest output. While making this adjustment, slowly rock tuning condenser rotor until maximum output is obtained. Repeat adjustments to be sure they are correct.

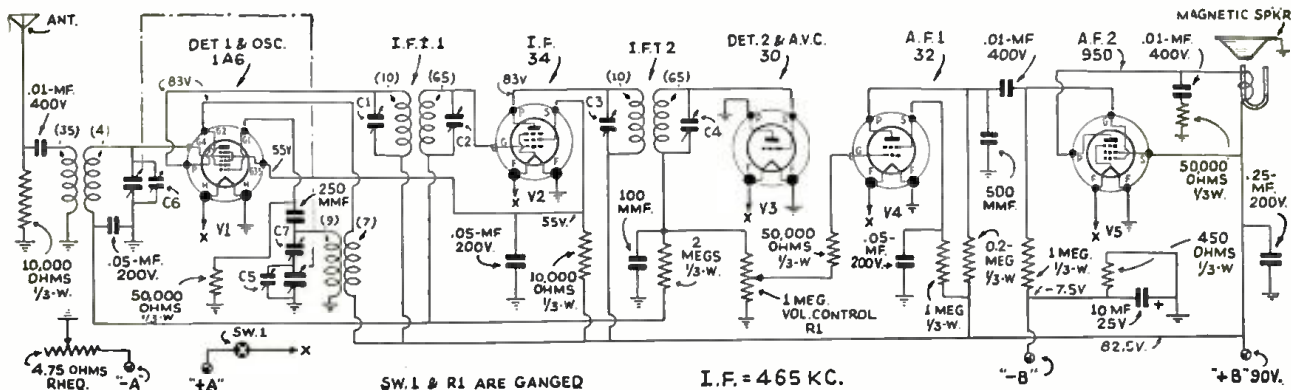
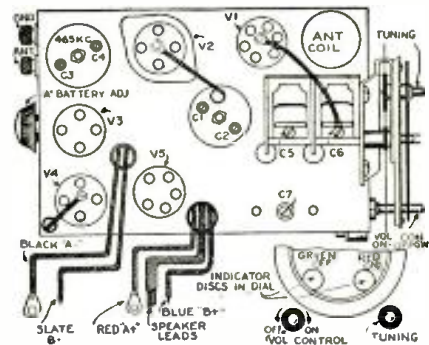

BELMONT MODEL 666 6-TUBE SUPERHET. AUTO RECEIVER

(Features: no suppressors; 6N6 output tube; iron-core antenna coil; metal tubes.)

Voltages for this receiver are shown on the diagram. They are read from the point indicated to chassis. While both the input from the antenna and all other input leads to the receiver are very thoroughly filtered, some cars will require additional treatment, and the usual remedies will be found adequate. Dummy antennas must be used with the test oscillator, the I.F. amplifier requiring a condenser of 0.1-mf. in series with the lead, while a 175 mmf. condenser is needed for the broadcast-band alignment. With receiver tuning condenser out of mesh and volume control full on, connect test oscillator lead to the cap of V3 and align the second I.F. transformer. Shift test oscillator lead to cap of V2 and resonate the first I.F. transformer. Connect test oscillator leads to antenna and ground of receiver and

set condenser of former at 1,550 kc., and with receiver tuning condenser at minimum, adjust oscillator trimmer (middle section) for best output. Shift test oscillator to 1,400 kc., tune signal in on receiver and adjust front and rear section trimmers. Set test oscillator to 600 kc. and adjust receiver padding condenser, rocking receiver tuning condenser back and forth at same time to insure correct setting. Recheck at 1,400 and 1,000 kc. Do not bend the plates of the receiver tuning condenser to correct tracking. The voltages given are measured with a full 6.3 V. input to the receiver. Antenna and ground leads should be shorted when testing voltages. The small diagram shows various speaker combinations and their connections. Any single or double combination may be used to suit the individual car installation.

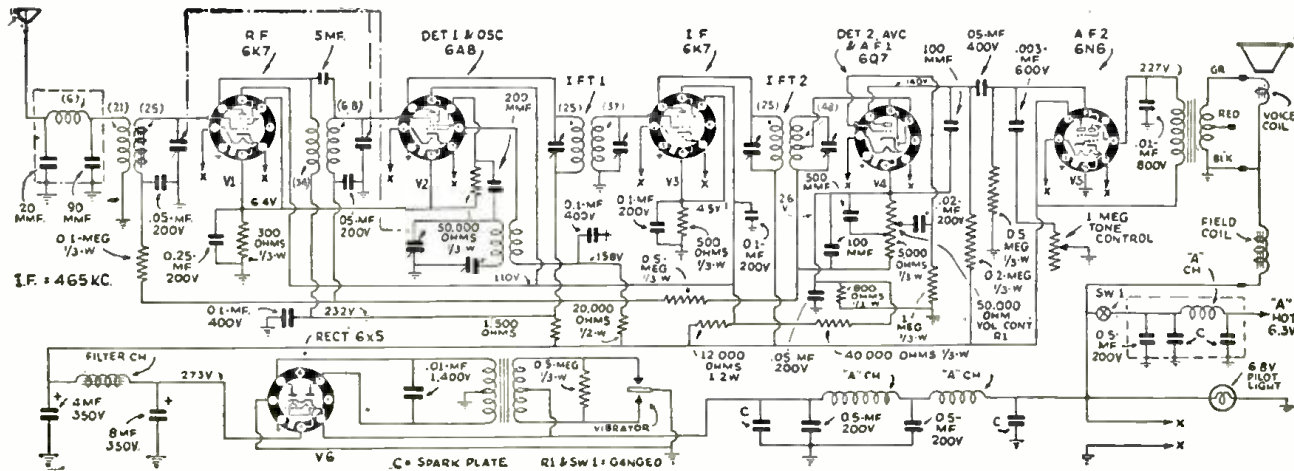
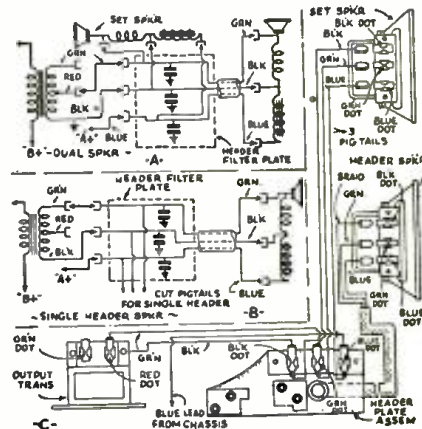

# TRANSFORMERS

FOR ALL PURPOSES

for example:

ULTRA-HIGH FREQUENCY Portable or Mobile TRANSCEIVERS should use some of the following:

- F-532-B—Microphone and Plate Primaries to Grid Secondary. Uncased, light weight, Net \$3.92
- F-533-B—Transceiver Output from plate of 33, 38, 41, etc. to 130,1000 or 2000 ohm handset or phones.....\$1.00
- F-536-B—Similar to F-532-B but for more powerful Transceiver using a 19 as push-pull R.F., 30 as audio driver, and 19 as Class B Modulator \$1.05
- F-534-C—Class B Input, 30 driver to 19 Grids Class B.....\$3.80
- F-535-B—Class B Output from 19 Twin to modulate 19. Sec. handles plate current of r.f. stage, impedance approx. 2700 ohms, or any 7 watt stage approx. 50 m.a. at 135 volts.....\$1.17



## General Replacement Transformers

will be found in our CATALOGUE No. 51-C

Three examples out of 161:

- No. 210—300-0-300 V. 40 m.a.; 2.5 V. 5.5 A.; 5V. 2A.....\$1.11
- No. 209—330-0-330 V. 60 m.a.; 2.5 V. 8.75 A.; 5V. 3A.....\$1.80
- No. 1103—Single Plate to Push-pull Grids.....\$3.98



High Fidelity Audio Transformers for Public Address, Broadcast and Amateur Stations will be found in our catalogues No. 70, No. 70-A. Description of all types for microphones, matching, interstage, and output, all fully cased and shielded. Useful diagrams included.

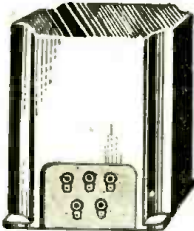

## AMATEURS!

SEND FOR CATALOGUE No. 52-C

Contains nearly a hundred stock transformers and chokes for all power phone and C.W. rigs, designed by Boyd Phelps, W2RP-W9BP. Illustration shows FTP-56 which delivers 3/4 K.W. and costs \$9.50 net.

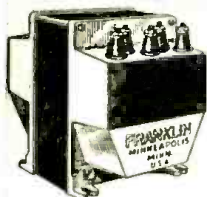

Any of the above catalogues free for the asking. If in a hurry, order direct from this ad or see your local jobber. If he does not have these lines tell him he is missing something well worth while.

DIATHERMY TRANSFORMERS made to your specifications

**FRANKLIN TRANSFORMER MANUFACTURING COMPANY**  
607-609 22nd Avenue N. E., Minneapolis, Minn.

## UNBREAKABLE P. A. TRUMPET

A radically new type of sound projector made of the specially processed RACON ACOUSTIC STORMPROOF material, with full-length bell reinforcement. Demountable in three sections, with cast aluminum throat and section couplings, with loose coupling for unit attachment. Unquestionably the strongest, most durable trumpet available, with characteristic RACON high acoustic efficiency.

Racon Electro-dynamic Units and Horns are manufactured under 14 exclusive RACON Patents. Write Dept. RC836 for catalog.



**RACON ELECTRIC COMPANY, INC.**  
52 East 19th St., New York, N. Y.

## WHAT ABOUT TELEVISION?

(Continued from page 73)

to be an attraction capable of drawing attention away from sound broadcasting.

These considerations about the future of television have shown us clearly that the most important condition for its introduction into the home is not the money to be spent for the installation of a television network, but the prices asked for a receiver. To make television popular the sets will have to sell at a much lower price! But, with popularity and volume, we believe that they will cost no more than a better-grade radio receiver costs today and they will become just as popular.

Although the cabinets of present television receivers bear close resemblance to sound broadcast sets they are actually highly-complicated devices consisting of 4 or 5 distinct parts, each of which must not only function correctly within its own sphere of activity, but must synchronize with every other part of the receiver.

The complex design of a present television set is clearly indicated by the number of the control knobs required. The recently-demonstrated experimental RCA receiver worked only after 14 knobs were manipulated. Of course, after the image had once been tuned in correctly, at least two-thirds of the control knobs did not require further attention; but nevertheless it is hard to imagine that a layman can handle such a labyrinth of control devices.

This single detail about the design of present American television receivers indicates that we have today about the same situation with television receivers as was the case with sound broadcast receivers in the early days of radio. Receivers were forbiddingly expensive, and had a large number of control knobs. Today there is only one control knob left for the actual tuning, and the 2 or 3 additional knobs which still remain are operated only once in a while, as for example when a change in wave-range is required. It took a long time to "induce" the many control knobs of sound broadcasting receivers to disappear but each time a knob disappeared a part of the initial high price disappeared too, and today we have the cheapest but the best radio receivers in the world.

### 5-TUBE TELEVISION SET OF THE FUTURE

The same evolution is to be expected as far as television-receiver design is concerned. We are at present only at the beginning of the design of receivers for high-definition image reception, and yet there are already some interesting signs that in a short time to come television receivers will be simplified to a considerable extent. Instead of the 32 tubes applied in the newest RCA television receiver, only 4 or 5 will be necessary in the television receiver of 1945. The main trick of these simplified television receivers will probably be the newly-developed electron-multiplier tubes (see Fig. 5). These tubes are at present quite expensive, and consequently do not promote price reduction in television receivers.

However, what mass production is able to do as far as tubes are concerned has been impressively indicated in the past. The first radio tubes were sold for about \$10 each. Tubes of today having an efficiency 5,000 times greater than the initial ones are listed at about \$1.00 or less. There is no reason to believe that the new electron-multiplier tubes (which also have the advantage of eliminating a great number of the television receiver circuit elements now required) should not be sold at a relatively reasonable price. This, if accomplished, would bring the television receiver within the reach of the man on the street.

(The contention had been made that such multiplier-type tubes, due to the number of elements incorporated in one envelope could not be maintained at the requisite high vacuum. But it will be recalled that Loewe in Germany has had on the market for several years multi-element tubes incorporating in one envelope not only the elements which comprise several tubes, but also all the resistors and condensers that go toward making up a complete amplifier—and even a radio receiver!—Editor)

### THE IMPORTANT ROLE OF THE TELEVISION AMATEURS AND EXPERIMENTERS

Our discussion so far has indicated that there are no short-cuts to the inauguration of television which would bring it within the next

year or so into every man's home. Two impediments have first to be overcome:

(1) The "1 tuning knob" television receiver has to be designed which must sell for a reasonable price (see the article, "World-Wide Television," *Radio-Craft*, August, 1935, page 80, Fig. 31).

(2) Quite a bit of interest has to be created for this new branch of radio communication by demonstrations in the vicinity of the listener's home.

Both tasks cannot be solved without the help of the amateur and experimenter.

Amateurs have actually boosted broadcasting reception technique in the past, and in fact some of the best men at present in the American radio industry formerly were amateurs. After broadcasting transmission and reception changed from a hobby into a money-making enterprise, amateurs were actually thrown out of the broadcast range, and restricted to the short-wave field, which at that time was without importance.

Again radio amateurs have done pioneer work, and have actually been responsible for exploring the short-wave bands. Their success in bridging continents with a few watts has not only promoted a completely new realm of long-distance communication but has also fertilized the field in which American radio industry has harvested the boom of the all-wave receiver.

The few engineers kept busy in the nation's leading television laboratories to solve design problems cannot do as much of the work as is necessary; nor can they attempt to equal the accomplishments of properly directed mass activity. To make television receivers cheaper and easier to operate, then, the aid of thousands of radio amateurs (and experimenters) will have to be enlisted.

In addition to their technical contributions towards fool-proof television receivers, amateurs will create interest among radio listeners by their demonstrations. This free publicity will again fertilize the field of which the American radio industry will harvest the fruits of its third boom, the fruits of the television era to come.

## TELEVISION AS HOME ENTERTAINMENT

(Continued from page 80)

### TELEVISION'S DEMANDS UPON THE ONLOOKER

Television broadcasting, on the other hand, absolutely fixes the looker. The room must be partially darkened, the looker must go to a specific place and must keep his eyes fixed on a small picture area (at this time about 5 x 7 ins. in size). If his attention is distracted, he completely loses the program. There is no chance to do other things nor can wandering attention be tolerated during a television broadcast. In fact, it demands in the home, and with relation to a small picture, all the attention which the audience must focus on the large screens in a motion picture theater.

Perhaps present broadcasting has taught the radio audience bad radio manners and perhaps television despite the nervousness or restlessness of many people, will help them to develop habits of attention to their own benefit.

The moral of all of this is that television is extremely new and untried; that its development will of necessity proceed experimentally and slowly; and that the burden upon those who create the programs will be indeed a heavy one. In fact, television programs must be so supremely interesting and attractive that they will justify, on the part of the lookers, the expenditure of (1) money, (2) time, and (3) attention—which are some of the most valuable things which the audience can give. Probably the needs of the situation will develop highly ingenious program creators who will accomplish what is needed in due course. But years of study, experiment, and program development must pass before the great television audiences of the future will be fully satisfied by the entertainment value of the programs sent to them.

Please Say That You Saw It in RADIO-CRAFT



### OPERATING NOTES

(Continued from page 89)

**Majestic 20.** No plate voltage on the R.F. amplifier, 1st-detector, and I.F. amplifier, was found due to a shorted 0.1-mf. condenser. This condenser is built in with the I.F. transformer and there is one in each I.F. transformer. To get the defective one out, the I.F. coil must be taken off and all wires to it unsoldered. Drill out the rivets holding the outside case, then place the transformer in a pan of water (making sure the water does not come high enough up the transformer to get into the inside); then place on a gas burner and let boil until the inside will pull out from the shield. Be very careful while scraping the pitch from around the I.F. coils as they are wound with very fine wire. The condenser may be found by tracing the red wire that goes to "B+." It is advisable to put in a good grade high-voltage condenser in place of the bad one as there is a high "B" voltage, of 422 V., in this set.

**Serenader 160.** Set was very noisy and at times gave intermittent operation. The trouble was located in one of the R.F. tube sockets; it was split at the plate prong, thus allowing the plate voltage to arc to ground. The split was very difficult to locate as it was only the thickness of a hair.

BRISCOE RADIO LABS.

### A FRENCH TELEVISION SYSTEM

(Continued from page 91)

a cathode-ray tube has been applied!

The scanner disk is completely enclosed in a case as Fig. 1 shows; a design which reduces the noise produced by a disk rotating in open air. To obtain a strong spot-light beam with a small light-source, lenses have been installed in the holes of the Nipkow disk. How efficient this lens system actually operates may be seen by the fact that only a 60-W. lamp is used as light source.

This lamp is of course of special design. It is a so-called "point-lamp." A kind of incandescent lamp without the usual type of filaments, but furnished with 2 small tungsten balls between which a small electric arc is produced. The light of such a lamp is not only of a very bright white color, but is also concentrated to a degree seldom obtained by the use of a carbon-arc lamp. A similarly-designed scanning disk has been used for the 60-line transmissions of the French broadcasting station "Poste-Radio-Lyon," in the southern part of France.

The chassis is designed in a 3-shelf form. Upon the bottom of the chassis (see Fig. B), the power supply and the sweep circuits have been installed. On the second shelf we see the image receiver, and above this receiver there has been suspended the cathode-ray tube. No means of sound reception and reproduction are provided in this laboratory set-up.

The receiver is a superhet. of normal design as used for the reception of medium-wave (broadcast band) transmissions on which the television signals are at present radiated by the broadcast station "PTT-Paris." Only the I.F. stages are tuned to a relatively broad band to avoid a cut-off of the image frequencies. The receiver is kept in synchronism with the transmitter by means of synchronizing impulses at the end of each line. In connection with this it might be of interest to mention that the sweep circuit operates with a thyratron tube which is applied as a resistor of variable resistance, which discharges a condenser.

The cathode-ray tube (of English make) is of the so-called high-vacuum-type, with a screen size of 6 x 10 ins. The plate and exciter voltage applied in this tube is about 3,000 volts. Although the image quality is too low to satisfy the public after the first curiosity has been satisfied, it is only the beginning of real television progress in France.

**DON'T FORGET THE SEPTEMBER-SPECIAL RADIO SET BUILDERS' ISSUE OF RADIO-CRAFT**

# WESTON

## price reductions

### save you up to

# 25%

**DON'T DELAY...  
ORDER THROUGH  
YOUR JOBBER, OR  
RETURN COUPON**

Increasing demand for these standard,  
precision test units makes these big  
savings possible:

<p><b>Model 692 ALL-WAVE OSCILLATOR</b> Was \$60<sup>00</sup> net</p>	<p><b>Now \$45<sup>00</sup> NET</b></p>
<p><b>Model 669 VACUUM TUBE VOLTMETER</b> Was \$59<sup>63</sup> net</p>	<p><b>Now \$45<sup>00</sup> NET</b></p>
<p><b>Model 780 CAPACITY METER</b> Was \$29<sup>25</sup> net</p>	<p><b>Now \$22<sup>50</sup> NET</b></p>
<p><b>Model 687 OUTPUT METER</b> Was \$15<sup>00</sup> net</p>	<p><b>Now \$11<sup>25</sup> NET</b></p>



Model 692 - All-Wave Oscillator
Model 669 - Vacuum Tube Voltmeter

Weston Electrical Instrument Corporation  
599 Frelinghuysen Avenue, Newark, New Jersey  
Send full data on these and other WESTON test instruments.

NAME \_\_\_\_\_

ADDRESS \_\_\_\_\_

Please Say That You Saw It in RADIO-CRAFT

# TECHNICIANS' DATA SERVICE

JOSEPH CALCATERRA DIRECTOR

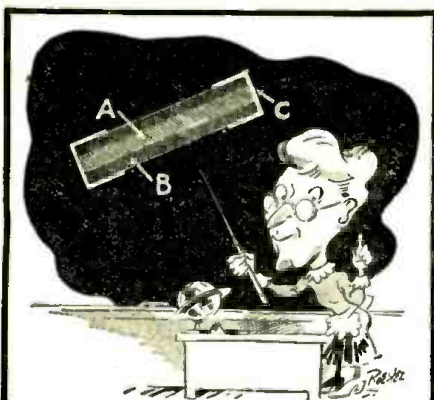

## The "ABC" of Sturdy Resistors

You'll go to the head of the class if you stick to CENTRALAB Fixed Resistors for your Replacement jobs.



- A** Center core of resistance material is surrounded by a dense shock-proof ceramic, providing strength and protection against humidity.
- B** Core and jacket are fired together at 2500 degrees F. into a single, solid unit, hard and durable as stone.
- C** Pure copper covers the resistor end for wire lead contact. Contact to the resistance material is at the extreme ends only, providing uniform resistance and load distribution over entire length. End contacts do not short circuit part of resistance as in other types.

# Centralab

MILWAUKEE WIS.  
 BRITISH CENTRALAB. LTD.  
 Canterbury Rd., Kilburn  
 London N.W. 6, England  
 CENTRALAB  
 68-70 Rue Amelot  
 Paris, France

## Your FREE COPY

**BARGAIN BULLETIN**  
 SAVE MONEY ON EVERYTHING YOU BUY!

SPORTING GOODS  
 WATCHES-CLOCKS  
 TYPEWRITERS  
 OPTICAL GOODS  
 CAMERAS-NOVELTIES  
 ELECTRICAL APPLIANCES, ETC.

**RADIO SETS AND REPLACEMENT PARTS**

is JUST OFF the PRESS

Contains hundreds of up-to-the-minute bargains, special's at PRICES THAT ARE SLASHED TO THE BONE!

"Save Money on Everything you Buy"—Send for your FREE COPY of this big new book—Join the thousands of satisfied customers all over the world who rely on "BARGAIN BULLETIN" for TREMENDOUS CASH SAVINGS.

This Catalog is ABSOLUTELY FREE—without any obligation. Just send us your name and address—a postcard will do.

**RADIO CIRCULAR CO., INC.**  
 915 Broadway, Dept. R.C., New York, N. Y.

A special arrangement between RADIO-CRAFT magazine and the publishers of this literature, which permits bulk mailings to interested RADIO-CRAFT readers, eliminates the trouble and expense of writing to each individual organization represented in this department.

2. HAMMARLUND 1936 CATALOG. Contains 12 pages of specifications, illustrations and prices on the new line of Hammarlund variable, mid-gate, band-spread and adjustable condensers; trimming and padding condensers; R.F. and I.F. transformers, coils and coil forms; sockets, shields, chokes and miscellaneous parts of ultra-short-wave, short-wave and broadcast operation.

3. HOW TO GET A HAMMARLUND 1936 SHORT-WAVE MANUAL. A circular containing a list of contents and description of the new 16-page Hammarlund Short-Wave Manual, which contains construction details, wiring diagrams, and list of parts of 12 of the most popular short-wave receivers of the year.

4. THE "COMET PRO" SHORT-WAVE SUPERHETERODYNES. Describes the outstanding features of the standard and crystal-type Hammarlund "Comet Pro" short-wave superheterodynes designed to meet the exacting demands of professional operators and advanced amateurs for a 15 to 250 meter code and phone receiver, but which can be adapted by anyone for laboratory, newspaper, police, airport and steamship use.

5. ELECTRAD 1936 VOLUME CONTROL AND RESISTOR CATALOG. Contains 12 pages of data on Electrad standard and replacement volume controls. Tru-volt adjustable resistors, vitreous wire-wound fixed and adjustable resistors and voltage dividers, precision wire-wound non inductive resistors, center-tapped filament resistors, high-quality attenuators, power (50- and 150-watt) rheostats and other Electrad resistor specialties.

53. ALADDIN POLYRON DATA SHEET 536. This new folder contains complete catalog descriptions, specifications, prices, performance curves and circuits showing applications of the complete line of Polyron radio components made by the Aladdin Radio Industries, Inc.

57. RIBBON MICROPHONES AND HOW TO USE THEM. Describes the principles and operating characteristics of the Amperite velocity microphones. Also gives a diagram of an excellent humless A.C. and battery-operated preamplifier.

59. THE EVOLUTION OF TUBE TESTING. This interesting booklet, published by the Supreme Instruments Corp., traces the development of tube testing equipment and gives a complete technical description, with wiring diagram and discussion of the technical points involved in the design and use of the Model 89 Supreme Radio Tester for testing all tubes, and also paper and electrolytic capacitors.

62. SPRAYBERRY VOLTAGE TABLES. A folder and sample pages giving details of a new 300-page book, containing 1,500 "Voltage Tables" covering receivers manufactured from 1927 to date, published by Frank L. Sprayberry to simplify radio servicing.

64. SUPREME No. 385 AUTOMATIC TESTER. A technical bulletin giving details, circuits and features covering this new Supreme development designed to simplify radio servicing. In addition to the popular features of Supreme analyzers and tube testers it contains many direct-reading features which eliminate guess-work or necessity of referring to charts or tables.

65. NEW 1936 LINE OF SUPREME TESTING INSTRUMENTS. This 16-page catalog gives complete information on the entire Supreme line of testing instruments, including the Model 385 Automatic Tube Tester and Analyzer, the Model 339 DeLuxe and Standard Analyzers, and other standard Tube Testers, Set and P.A. Analyzers and Signal Generators. Complete details of the Supreme Easy Payment Plan for purchasing testing equipment on the installment plan are given.

67. PRACTICAL MECHANICS OF RADIO SERVICE. Information, including cost, features and outline of lessons of the Frank L. Sprayberry course in Radio Servicing, and list of Sprayberry Data Sheets for modernizing old radio equipment.

69. YOUR FUTURE IN RADIO. With the development of Radio into many specialized fields, it has become increasingly important for anyone considering radio as a lifework, to investigate the opportunities offered in the various fields

for a man of his particular qualifications. These opportunities are described in an interesting 32-page book, "Your Future in Radio" published by the Sprayberry Academy of Radio. It also gives complete information on the new Sprayberry Course in Radio Service Engineering which includes all standard equipment and supplies for the practical work required in mastering the course and going into business.

73. HOW TO ELIMINATE RADIO INTERFERENCE. A handy folder which gives very complete information on how to determine and locate the sources of radio noise by means of the Sprague Interference Analyzer. A description of the analyzer and method of using it is included, together with data on how to eliminate interference of various kinds once the source is located.

74. SPRAGUE 1936 ELECTROLYTIC AND PAPER CONDENSER CATALOG. Gives specifications, with list and net prices on a complete line of wet and dry electrolytic, and paper condensers made by the Sprague Products Co. for radio Service Men, set builders, experimenters and engineers. Information on the Sprague Capacity Indicator, for making capacity tests on condensers and in servicing receivers, is included.

75. SPRAGUE TEL-U-HOW CONDENSER GUIDE. A valuable chart, compiled by the Sprague Products Co. which tells the proper types, capacity values and voltages of condensers required in the various circuits of radio receivers and amplifiers, and how to locate radio troubles due to defective condensers. Includes data on condenser calculations.

76. FACTS YOU SHOULD KNOW ABOUT CONDENSERS. A folder, prepared by the Sprague Products Co., which explains the importance of various characteristics of condensers, such as power-factor, leakage, capacity and voltage in determining the efficiency or suitability of a given condenser to provide maximum filtering and safety in operation.

Radio-Craft Technicians' Data Service  
 99 Hudson Street,  
 New York City, N. Y. RC-836

Please send to me, without charge or obligation, the catalog, booklets, etc. the numbers of which I have circled below.

2	3	4	5	53	57	59	62
64	65	67	69	73	74	75	76

My radio connection is checked below:

- Service Man operating own business.
- Service Man for manufacturer.
- Service Man for jobber.
- Service Man for dealer.
- Service Man for servicing company.
- Dealer.
- Jobber.
- Experimenter.
- Professional Set Builder.
- Amateur Set Builder.
- Short Wave Work.
- Licensed Amateur.
- Station Operator.
- Radio Engineer.
- Laboratory Technician.
- Public Address Worker.
- Manufacturer's Executive.
- Student.
- 

I am a:

- Subscriber  Newsstand reader
- I buy approximately ..... of radio material a month. (Please answer without exaggeration or not at all.)

Name .....

Address .....

City ..... State .....

(Please print name and address)

Avoid delay. The catalogs and booklets listed are now in stock and will be sent promptly as long as the supply lasts. Please use this coupon in ordering. The use of a letter causes confusion and delay.

Please Say That You Saw It in RADIO-CRAFT

## HIGH INTENSITY ILLUMINANTS IN TELEVISION

(Continued from page 76)

source shortly will be available for television purposes. (The newest Westinghouse type, released June 1, 1936, and illustrated in the heading, is here shown for the first time in any magazine!—Editor)

### CANDLEPOWER THAT RIVALS THE SUN!

In the air-cooled variety the intensity of the capillary vapor stream is approximately that of the electric arc crater or 85,000 candlepower per sq. in. But where the capillary is water-cooled by being encased in an outer glass tube through which a rapid stream of cold water is maintained flowing, high mercury pressures (20 atmospheres) are obtained; and a light intensity value equal to that of the sun's disc, or some 250,000 candlepower per sq. in.!

(The lamp in the heading illustration measures about 5 3/8 x 1 1/4 ins. overall, the actual light element being only 1 1/2 x 1/2-in. in dia. It is operated from a transformer which delivers around 250 V. at the secondary, and the mercury arc is approximately 1/2-ins. long, a striking contrast with the usual mercury- (or Hg-) vapor lamps in which the arc is of varying lengths from 6 ins., up. Thus the ideal "point source" is approached more closely than ever before in this type, which fact makes its use in television of the greatest interest. As with other lamps of the mercury-vapor type, the starting time is 3 to 4 minutes, before full brilliance is attained. Many other, larger sizes are made, that shown being the smallest at present.—Editor.)

**Indirect Modulation.** Whereas a water-cooled device of this nature would scarcely be practical in a home, the less brilliant, air-cooled high-pressure mercury-vapor source appears to give sufficient brilliancy even after the light passes through 2 polaroids (Nicol prisms, or equivalent) and a Kerr cell, and necessary lenses, etc., to illuminate with acceptable brilliancy a screen area of at least 4 sq. ft.

**Direct Modulation.** While the most obvious use of this new mercury vapor lamp would be as a fixed source with light valve modulation, it is not at all uncertain that the brilliancy of this source can not be directly modulated at television frequencies by means of a suitable power amplifier. If so, this latter arrangement will afford many advantages over the fixed source with Kerr cell and polarizing devices.

There seem to be as yet untried possibilities in the future development of the so-called crater lamp source. The ultimate in a high-intensity, long-life crater lamp, either with a hot or a cold cathode, has not yet been reached. However, and although several investigators and manufacturers are still at work on the problem, it is doubtful whether any crater lamp will equal in intrinsic brilliancy that of the capillary quartz mercury- (Hg-) vapor source above described.

### ULTRA-HIGH INTENSITY CATHODE-RAY BEAM

Akin to the crater lamp is the fixed-beam cathode of a source using a long, cylindrical, cathode beam tube containing sufficient gas to aid in focusing the beam to a very small spot and directing this fixed beam either upon a fluorescent coating upon a quartz window at the end of the tube which will successfully withstand the highly intense bombardment, or directing the beam at a 45 deg. angle upon a fluorescent, coated metal plate and viewing the spot through the side of the tube. In either construction it is obvious that the fluorescent surface must have no appreciable time lag, nor can the quartz or metal surface on which it is deposited become heat luminous. It is not difficult to construct air-cooled tubes of this nature which remain sufficiently cool to avoid redness of the bombarded surface.

The small number of milliamperes involved in this cathode-beam light source and the ease with which the beam can be modulated at television frequencies are arguments in favor of this type of light source for home television. (See the article, in this issue of Radio-Craft by Dr. Stager.—Editor)

The ensuing year's development should pretty well determine which of the above-described sources of high-intensity illuminants will be the most practical for television in the home.

## THE BIGGEST OPPORTUNITY IN RADIO TODAY

# \$ \$ SOUND \$ \$



Webster-Chicago Model C-10

## FREE System on NATIONAL UNION Deal

3-Stage, 10 Watt Amplifier. Mixes microphone and phonograph. 2-Button carbon microphone—stretched duraluminum diaphragm—banquet stand—25 feet cable. High grade 8" D.C. Dynamic Speaker. (System handles one or two speakers.)

### SOUND EQUIPMENT . . . . SENSATIONAL EXPANSION THIS YEAR . . . . VOLUME GROWING BY LEAPS AND BOUNDS . . . . NEW USES FOUND EVERY DAY.

National Union believes this field should gravitate to the radio service dealer. Now is the time to get started. National Union makes it easy for you to go into this business by furnishing equipment on National Union deals, requiring minimum outlay of cash. Further, National Union will help you learn the business; how to sell, how to rent, how to expand, how to explore the possibilities, just the same way that they did in helping service dealers build up service work. Don't delay—Get into sound now!

#### Other National Union Offers

In **SOUND EQUIPMENT** items available include 17 watt portable system, 10-watt mobile system, phonograph pickup and turntable, etc. In **SERVICE EQUIPMENT** items available include tube testers, analyzers, oscillographs, signal generators, modulators, meters, etc. In **SHOP EQUIPMENT** items available include stock cabinets, coats, display signs, etc.

National Union Radio Tubes Are Handled and Recommended By More Service Dealers Than Any Other Make.

All items available free on attractive National Union deals.

#### The National Union Way

Through National Union's help, radio service dealers everywhere have been able to set up better equipped shops to do better work; also to obtain merchandise helps that produce more customers. National Union has constantly put the latest advances in scientific equipment as well as modern selling aids within the reach of the service dealer. The National Union deal calls for a dealer deposit which is rebated when the specified number of tubes have been purchased. Over 50,000 completed deals. Every service dealer should investigate.

**Act Now! Send Coupon!**  
**Let National Union Help You!**

See Your National Union Jobber. Write for Complete Information.

**THE ROAD TO BETTER BUSINESS**

1. Full guarantee on highest quality radio tubes.
2. Cut price business not solicited.
3. Price Protection.
4. N. U. jobber stocks are complete. No hunting for odd types.
5. Timely business building aids.

National Union Radio Corporation  
570 Lexington Ave., New York City  
Please send me more information on  
—Free offer for Webster Chicago Sound System C-10.  
—Free offer for .....

Dealer Name .....

Address .....

City ..... State.....

## THERE'S A GOOD JOB FOR YOU IN RADIO

We Will Train You Quickly to Qualify

The servicing of modern radio receivers requires experts—men trained for this work are needed everywhere.

### RADIO OFFERS BIG OPPORTUNITIES

Your possibilities of making money are limited only by your ability and skill. There is no room for the soldering iron "guesser." But you must be trained—the sooner you begin the quicker you'll cash in.

#### LEARN AT HOME

We will train you at home to service and repair radio receivers of all types. Invest for future success in R.T.A. training.

#### NO EXPERIENCE NEEDED

You need no previous experience in Radio. We show you how to make money almost from the start. Hundreds of men are enjoying the rewards of R.T.A. training.



**FREE**  
of extra cost

This time saving trouble-finder and circuit analyzer included.

Full details of this great opportunity are explained in a helpful book that is **FREE**.  
Send for it today. It will be mailed at once.

**RADIO TRAINING ASS'N OF AMERICA**  
Dept RC-68, 4525 RAVENSWOOD AVE., CHICAGO

Please Say That You Saw It in RADIO-CRAFT

**Presenting Model T-37 . . . . A SIGNAL GENERATOR that "Does Everything" only \$12<sup>40</sup>**



Released by SUPERIOR INSTRUMENT CO., for limited time only.

- 110 Volts A.C. or D.C.
- 100 kc.—20 megacycles all on fundamentals.
- Dial is direct reading in frequencies.
- I.F. output may be taken from a high impedance or a low impedance post, in with attenuation present for either.
- Separate audio output at 2 amplitude levels, so that tone may be used for checking public address systems, audio amplifiers in receivers, and speech amplifiers in transmitters.
- Two extra posts on front panel enable leakage tests. Condensers may be checked for leakage, so may tubes, and other normally high resistance currents, otherwise difficult to test.

Model T-37 All-Wave Signal Generator, wired, in shielded cabinet with carrying handle and calibrated, tested; complete with 3 tubes, instructions \$12.40 (shipping weight 7 lbs.)

**SUPERIOR INSTRUMENTS COMPANY, 139 CEDAR STREET, NEW YORK, N. Y., Dept. T-2**

**AMERICAN TELEVISION INSTITUTE ANNOUNCES**

The merger of our American Television Manufacturing Company and the Laboratory of U. A. Sanabria to engage directly in the television business nationally through our trained engineers now available in every State.

We are now manufacturing and distributing a complete line of television and electronic devices. We invite you to inquire and address

**666 LAKE SHORE DRIVE CHICAGO, ILLINOIS**

**INTER-ELECTRODE CAPACITY**

THE EXPERIMENTER often needs to know the capacities between tube elements, this need becoming increasingly great at the high and ultra-high frequencies.

The capacities of the glass tubes are given in the table below, printed by the courtesy of National Union Radio Corp., with the glove-type shields over the tubes and throughout the table the figures are given with the shield connected to cathode in both glass and metal types.

TYPE	INPUT		OUTPUT		Cap. MAX.
	Shielded	Unshielded	Shielded	Unshielded	
6H7+	4.5	3.5	10.5	9.5	0.007
6C6	5.8	5.0	8.9	6.5	0.007
6D6	5.5	4.7	8.9	6.5	0.007
6E7*	4.0	3.2	13.3	12.5	0.007
6J7	7.0		12.0		0.005
6J7G	4.8	4.3	12.0	11.6	0.007
6J7MG	5.2		11.5		0.007
6K7	7.0		12.0		0.005
6K7G	4.8	4.1	12.5	11.6	0.007
6K7MG	5.0		11.5		0.007
6L7	8.5		12.5		0.0005
6L7G†	6.2	5.4	10.5	8.2	0.002
6L7MG†	7.0		10.5		0.001
77	5.5	4.7	12.1	11.0	0.007
78	5.3	4.5	12.1	11.0	0.007

\*Pentode Section. †As Amplifier.

TYPE	Cg-k		Cp-k		Cgp	
	Sh.	Unsh.	Sh.	Unsh.	Sh.	Unsh.
6C5	4.0	3.2	13.0		1.8	
6C5G	4.2	3.2	5.5	2.8	2.4	2.8
6C5MG	4.2		5.4		2.4	
6E6**	3.0	2.5	15.8	12.0	1.9	2.0
6E7††	2.9	2.5	3.5	3.0	1.9	2.0
6R7+	5.5		4.0		2.5	
6R7G+	2.8	1.5	6.8	4.0	1.8	1.8
6R7MG+	3.0		5.8		1.7	
76	4.5	3.5	5.1	2.5	2.6	2.8
85+	2.8	1.5	6.9	4.3	1.3	1.5

\*\*Triode Connected. ††Triode Section. Units—mmf. + diodes hooked to cath.

**Get on the List for These BIG CATALOGS**

Here are the mastheads of the four catalogs sent to every Burstein-Applebee customer this year. Each book is brimful of latest information and lowest wholesale prices on Radio, Electrical and Refrigeration equipment. Write today—get your name on the list to receive these valuable catalogs FREE.

**BURSTEIN-APPLEBEE CO.**  
1012-14 McGEE ST., KANSAS CITY, MO.

**6L6 60 WATT 30-13,000 CYCLES ± 1 D. B. MULTIPLE COIL, Hum Free Construction Push Pull INTERSTATE TRANSFORMER**

In Alloy Humproof Case **\$7.00** List

6L6 60 Watt Output Transformer into 500-15-8-4-2 in Alloy Hum-Proof Case . . . . . List \$10.00  
Columbia Diagram of 6L6 60 Watt Amplifier with Full Parts List, and employing Cathode Ray Indicator Tube, Automatic Feed Back Reducer, etc. . . . . \$0.40

**ALLOY TRANSFORMER CO., Inc., 135R Liberty St., N. Y. City**

**Buy Direct From Manufacturer . . . AND SAVE BIG MONEY!!!**

WRITE FOR OUR NO. 533

**FREE CATALOG**

OF RADIO & AMPLIFIER Replacement Parts, Power Amplifiers, Complete Amplifier Systems, Short Wave and All Wave Radio Receivers, Audio and Power Transformers, etc., etc.

**We Specialize In The Manufacture of Amplifiers**

Our prices are therefore the lowest in the industry . . . . . write us first.

**Remington Radio & Electric Corp.**  
106-W 7th Avenue, New York, N. Y.

**THE "ELF" A 2-TUBE SET FOR THE BEGINNER**

(Continued from page 82)

since the substitution of a single part will necessitate changes in the positions of the components, to make them fit—so the placement of the apparatus has been left to the builder. Just make sure you have everything in such a position that there is enough clearance for moving parts such as condenser plates, variable resistor rotor, etc.

The smallest parts consistent with good results were included in this set. The tuning condenser is an air-dielectric type with tiny plates but the spacing between plates is much less than usual. The volume control resistor is only 1½ ins. in diameter. This resistor was made for use in measuring instruments and the highest resistance available is 15,000 ohms; for this reason, the tickler coil is larger than usual.

The coils were made from an aerial coil of the iron-core type taken from a superhet. set. The primary is a high-impedance winding which is sufficient for the tickler, but the secondary was found to have too many turns when the coil shield was removed. It was necessary to remove 12 turns to make it cover the broadcast band, but the actual number can be found best by experiment, in the individual set.

For those experimenters who have difficulty in obtaining a suitable coil or prefer to make their own, the spider-web type of coil will be best. The coils should be wound the same—with the same number of turns—on cardboard forms 2¾ ins. in diameter and having 9 slots equally spaced around the circumference and cut ¼-in. deep by ¼-in. wide. The wire, which should be No. 28 single-cotton covered, is wound through alternate slots (every second slot); which makes a compact and rigid coil. The two coils should be mounted with a space of about ⅝- to ¾-in. apart. A total of 77 turns of this wire is required for each coil.

The author wishes to credit QST magazine for the ingenious arrangement of the detector circuit. The A.F. amplifier circuit was suggested by Mr. Arthur C. Miller, who has done considerable work on low "A" and "B" drain circuits using sub-normal filament temperatures.

The wiring must be done neatly and parts mounted rigidly, for the spacing between them

is so small. These details can be figured best by each builder. Both schematic and picture wiring diagrams are included for the convenience of those who make the set.

The aerial required for this set depends on the distance from the stations to be picked up. The aerial used by the writer for receiving the stations in the New York area, at a distance of about 30 miles from the local transmitters was a piece of wire about 15 ft. long, dropped onto the floor. Greater volume and more distant stations can be heard if a better aerial can be used.

**LIST OF PARTS**

One card file case, 3 x 6 x 4½ ins. high (inside dimensions);

One piece of aluminum 9½ x 6 ins. for panel and chassis;

\*One iron-core aerial coil with secondary changed; or spider-web coils (see text), L1, L2;

One Cornell-Dubilier mica condenser, 50 mmf., C1;

One Hammarlund variable condenser, 325 mmf. type CM325, C2;

One Cornell-Dubilier mica condenser, 250 mmf., C3;

One Cornell-Dubilier mica condenser, 100 mmf., C4;

One Continental Carbon fixed carbon resistor, 2 megs., R1;

\*One variable resistor (midget type) 15,000 ohms, R2;

One Franklin Transformer Co. A.F. transformer, 3:1 ratio or higher, T1;

Two National Union type 49 tubes, V1, V2;

Two 5-prong wafer sockets;

One toggle switch;

Two phone tip jacks;

\*One 3 V. "A" battery, type X152;

\*Two 7½ V. "B" batteries, type X204;

Wire, screws, solder, knobs, etc.

\*The name of the manufacturers will be sent upon receipt of a stamped addressed envelope.

Please Say That You Saw It in RADIO-CRAFT

# A NEW VARIABLE-ATTENUATION EQUALIZER

(Continued from page 80)

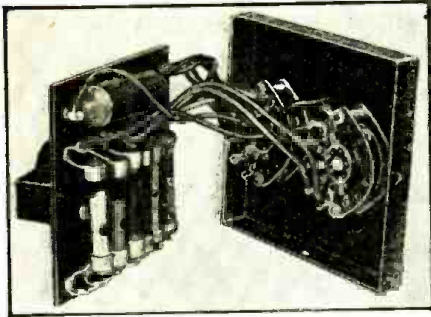

Fig. B. The interior of the device.

satisfactory performance. It is the purpose of the Equalizer to assist in correcting such faults by providing a means for overcoming muffled, boomy and harsh reproduction, reverberation and low-frequency feedback (howling). Furthermore, the Equalizer becomes the medium by which a P.A. system provides voice reproduction and instrumental reproduction with equal ability. In other words, the necessary accuracy of voice reproduction, and the just as necessary pleasing quality of music may be had through suitable equalizer adjustments.

All P.A. engineers recognize that greater emphasis on middle high-frequency response will in most cases compensate for those factors usually responsible for unsatisfactory reproduction, and in the Equalizer such necessary regulation of response characteristics is made possible by 2 variable switches; one governing the amount of attenuation introduced, and the other fixing the cross-over frequency at which attenuation begins. This latter control allows the selection of the frequencies that are to be accentuated, and since 5 positions are provided, representing 5 different frequencies, the equalizer has in effect a wide application. The attenuator affects only those frequencies below the cross-over point in steps of approximately 2½ db., thus providing more or less emphasis, as required, on the middle high frequencies at each setting of the cross-over selector.

With the equalizer in operation, the effect on the response characteristics of a sound system may be determined from the curves shown in Fig. 2. The group of curves (solid line) are the results with cross-over switch at point one, and the attenuator at each of the 5 positions provided, the numerals at the left indicating the attenuator sitting for that particular curve. The attenuation of the frequencies below the cross-over is clearly shown by these curves, and the resultant reproduction may be judged by the comparative predominance of the middle high frequencies. The curves (dotted lines) to the right are those with attenuator at point 5, and cross-over varied progressively from 2 to 5. The characteristics thus shown, are with maximum attenuation, and will be affected in the same proportion as the other curves by a change in the amount of attenuation.

An additional feature is provided by the response characteristics with cross-over switch at point 6 and the resultant curve, designated in Fig. 2 by the letters P.A., shows attenuation of the higher frequencies which provides increased emphasis on the middle highs so essential to crisp, clear reproduction. The attenuator switch functions as before, affecting only the frequencies below cross-over, and enabling the operator to accentuate the middle highs to a more or less degree. In this type of characteristic more power is contributed to the useful frequencies which are essential to good P.A. reproduction, and the system may when circumstances require it, be operated at higher levels than would ordinarily be satisfactory without suitable compensation. For most sound systems, the "P.A. setting" will be

found generally useful in handling all types of input in order to obtain satisfactory reproduction.

There are 30 different response characteristics possible with the equalizer, all of which may be graphically determined. The curve resulting with cross-over at 3, and attenuator at 2, may be found by extending the solid-line curve 2 until it intersects dotted-line curve 3. Similar methods may be used in finding curves for the other switch positions.

The location of the equalizer in the circuit is important, since it is a low-power device, and should not be subjected to more than 1½ W., but because of this low operating level, the insertion loss of 5 to 12 db. is negligible, and may be compensated-for by raising the gain through the amplifier. Proper matching of input and output impedances is necessary to maintain the characteristic curves shown in Fig. 2, as well as to preserve the matching balance of the system in which the equalizer is installed.

The connection diagrams in Fig. 3 illustrate one use of this Equalizer in two types of circuits: (1) direct input line; and (2) trunk line. From the nature of their use, the terms "series" and "bridging," respectively, have been applied to the two Equalizers required. With a single input line to the amplifier from the microphone, the equalizer should be inserted either ahead of the amplifier, or between the preamplifier and amplifier. In either case, it is essential that the impedance of the line (or output impedance of the preamplifier) and the input resistance of the amplifier properly match the input and output values provided in the equalizing unit. The series equalizer is available in two models, one for 500-ohm lines, and the other for 200-ohm lines. The use of the bridging type is indicated in those installations where a main input or trunk line of low impedance, to which it is desired to connect the equalizer, also serves other equipment at line impedance. For this purpose, the device is designed with a high-impedance input and output on the order of 20,000 ohms, drawing negligible power on the input and therefore not appreciably altering the impedance of the system.

While a unit of this type cannot be considered as a panacea for all ills of a sound system, it nevertheless provides an effective and practical means for improving the reproduction in a quick, easy manner—removing much of the guess work in designing an installation, and assuring favorable compensation for the many different problems which are encountered during operation.

The following notes refer to Fig. 3:

Note 1.—Output impedance of amplifier must match (combined) input impedance(s) of reproducer(s). Equalizer can feed 1 or more amplifiers but the input resistance of 1 (or of all amplifiers combined) must be 200 or 500 ohms.

Note 2.—Output level not over 10 W. (+ 32.2 db.) or 20 W. (+ 35.2 db.), depending on reproducer.

Note 3.—Line from device having 200- or 500-ohm output, or lines of corresponding impedance input to equalizer—not over 1.5 W. (+ 24 db.)

Note 4.—These leads must be as short as possible because of high-impedance line.

Our Information Bureau will gladly supply manufacturers' names and addresses of any items mentioned in RADIO-CRAFT. Please enclose stamped return envelope.

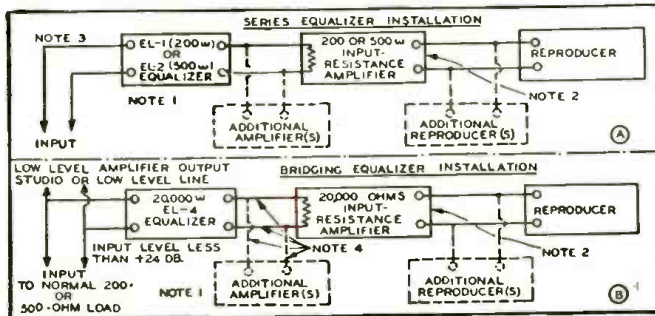

Fig. 3. Two types of equalizers for series and bridge connection.

Please Say That You Saw It in RADIO-CRAFT

# FREE RADIO CATALOG

This big, all-inclusive radio catalog is yours for the asking. It lists thousands upon thousands of items—anything and everything in radio, for hams, experimenters, service men and dealers. Whatever your needs may be—a 4 or 24 tube receiver, all-wave and short wave mantels and consoles; parts; tubes; kits; accessories; amateur equipment; P.A.—they can be comfortably and economically filled while you sit in your easy chair at home. You will find nationally known, nationally advertised merchandise at lowest WHOLESALE prices backed by a guarantee of Wholesale Radio Service Co., Inc., the largest radio institution of its kind in the world.

FOR EVERYONE



INTERESTED IN RADIO

This convenient catalog will serve as a handy reference book and shopper's guide to radio. It is thorough—complete—and it brings the world of radio to your door. Back of it all is a competent organization of experienced radio engineers and service men, whose services are available at all times in helping you with your radio problems. Be sure to get a copy of this helpful catalog for your own use. You will enjoy the assurance of knowing that every single item carries the guarantee of WHOLESALE RADIO SERVICE CO., INC. You will like our service too—the fastest, most dependable service in the field. Five huge, conveniently-located branches bring overnite service to most parts of the country—and these five branches are brought to you in the pages of this catalog.

MAIL THIS COUPON TODAY

Wholesale Radio Service Co., Inc. Dept. H-3  
901 W. Jackson Blvd., Chicago, Ill.  
Please RUSH catalog by return mail.....

Name .....  
Address .....  
Town ..... State .....

**WHOLESALE RADIO SERVICE CO.**  
NEW YORK, N.Y.  
100 SIXTH AVE.  
CHICAGO, ILL. 901 W. JACKSON BLVD.  
ATLANTA, GA. 130 W. PEACHTREE ST. NW  
BRONX, N.Y. 342 E. FORDHAM RD.  
NEWARK, N.J. 219 CENTRAL AVE.

# ★ NEWS! ★ From AMPLIFIER HEADQUARTERS

## NEW! A HIGH FIDELITY DUAL MIXER—DUAL GAIN—AMPLIFIER For Ribbon Velocity or Crystal Microphones

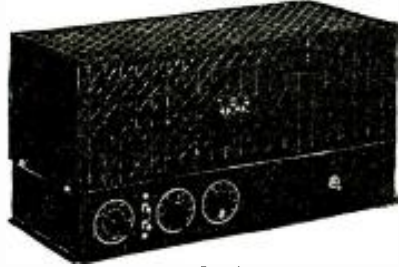

PRICE NET **\$15.75**

A COMPLETE WELL ENGINEERED UNIT UTILIZING ONLY HIGHEST QUALITY MATERIAL THROUGHOUT AND DESIGNED TO GIVE STEADY RELIABLE TROUBLE FREE PERFORMANCE.

Incorporating such outstanding features as— independent 18-watt field supply—multi-tap output transformer—hi and lo gain inputs—plug-in connections plus terminal posts—acoustic compensator—automatic sentinel (exclusive) all housed in a beautiful custom stamp chassis easily places this amplifier at the head of the sound equipment field.

FURNISHED COMPLETE WITH A SET OF SHIELDED PLUGS AND OPERATING INSTRUCTIONS.

**GILLETTE AMPLIFIER LABS**  
160 DUANE STREET NEW YORK CITY

## HIGH-FIDELITY WIRED SOUND

(Continued from page 81)

heretofore has been a thorn in the side of the paid musician, but this new system plans rather to enhance the status of the musical entertainer by maintaining the highest level of music appreciation during those hours and under those conditions which will not endanger his livelihood.

Thus, among the subscribers in New York is the large Waldorf-Astoria Hotel. (See Fig. A, in the heading.) They use this service during the day when there are no orchestras playing in their ballrooms and diningrooms, and during the evenings as "fill-in" between the rest periods of their orchestras.

This new service consists mainly of high-fidelity recordings sent at audio frequency over specially-balanced telephone lines. These recordings are made by the "vertical-cut" method and are reproduced by "vertical" pickups, thereby assuring almost perfect reproduction with negligible background hiss (as compared to the "lateral-cut" programs ordinarily used in the home). The records are of the 33 1/3 r.p.m., slow-playing type.

Figure B is a photo. of one of the control rooms showing 2 phonograph turntables and the units used to fade their outputs in and out as desired. The output of the phonograph pickup is fed to an equalizer and low-power amplifier, and from there to one of several 50-W. amplifiers located in the main control room shown in Fig. C. This sequence of operations is shown by block diagram A in Fig. 1.

From each of these 50-W. amplifiers the music is sent to the various telephone exchanges for distribution, as shown at B in Fig. 1.

The frequency response of these 50-W. amplifiers, which are push-pull throughout, is essentially flat from 30 to 14,000 cycles, and the harmonic distortion is only 0.5-per cent, thereby

assuring absolute fidelity of reproduction.

The telephone lines used for distribution are not those ordinarily used for telephone conversations. They are specially-balanced, 200-ohm lines, flat to 8,000 cycles and dropping only slightly to 10,000 cycles.

The signal is fed into the line at a level of zero db. (6 milliwatts). By the time it reaches the subscriber at the receiving end it has been attenuated to a level of -7 or -8 db. The receiver however is capable of stepping it up with perfect fidelity to a maximum of 40 db. This volume is controllable by the subscriber. On long transmission lines there is the usual tendency for the high frequencies to become somewhat attenuated. This condition however is remedied at the receiving end by a specially-designed equalizing network which attenuates the low frequencies in such proportions as to make the frequency response of the line essentially flat once more.

At the receiving end simple installations consist of a small amplifier and a single, high-quality speaker, as shown pictorially in Fig. D. More elaborate (console type) installations use two or more large reproducers plus several "tweeters" (high-frequency speakers), as shown in the heading illustration, to enable the reproduction fidelity to most nearly simulate the original.

The high-fidelity reproducer shown in the heading illustration incorporates several novel innovations. For instance, the front or baffle is hinged, and by loosening 6 wingnuts may be removed from the combined speaker and amplifier bay, folded together like a fireplace screen, and put away or removed to another location. Then, the speaker-amplifier bay, shown in Fig. E, may be tilted backward onto wheels, and rolled to a new location. The amplifier section of this bay raises the line output level to that required by the design of the individual, accompanying reproducers.

In rural districts it is sometimes convenient to utilize a carrier current or "wired radio" system, in which the program is superimposed on a radio-frequency carrier and this carrier fed onto the electric light lines that power the district, the carrier and its program being taken off by simple "receiving sets" (identical in appearance to the "set" shown in Fig. D, except that a selector switch is added) that separate the program from the carrier.

When it is recalled (*Radio-Craft*, June, 1936, pg. 759) that there are about 1,000 municipalities with populations of over 10,000, and that the larger towns offer proportionately larger opportunities for this type of entertainment service, the tremendous extent of this new field becomes increasingly inspiring.—Editor



Fig. D. A small-space "audio receiver."

**TELEVISION**  
with  
**CATHODE RAYS**  
ARTHUR H. HALLIDAY

**FLASH!**

Now, for the first time, you can read AUTHORITY information on the systems of Television which will actually be used by the large television corporations. This newest book, "Television With Cathode Rays," tells you what you want to know. Price \$2.75 per copy, including one year supplementary service. Order from:

**Pacific Radio Pub. Co., Inc.**  
P. O. Box 3278  
San Francisco, California

**One Year SUPPLEMENTARY SERVICE... Included without Extra Charge**

**FULL PRICE \$2.75**

### To Readers of RADIO-CRAFT FREE POST CARDS MAY BE HAD UPON WRITING TO PUBLISHERS

These post cards make it easy to answer advertisements which appear in RADIO-CRAFT, without cutting valuable data which you may wish to save.

Many times manufacturers request you to "clip the coupon" when answering their ads. Often this means destroying part of an article on the reverse page you may need later for reference. Save your RADIO-CRAFT issues complete. If you should ever want to sell bound volumes, or certain copies of RADIO-CRAFT, the resale value of uncut issues is very much higher than that of mutilated ones. So send for a supply of these free post cards and use them in answering all RADIO-CRAFT advertisers.

**TRI-STATE COLLEGE**  
Radio  
Engineering

Degree in 2 Years

Complete Radio Engineering course in 96 weeks. Bachelor of Science Degree. Radio (television, talking pictures and the vast

electronic field) offers unusual opportunities for trained radio engineers. Courses also in Civil, Electrical, Mechanical, Chemical, Aeronautical, Engineering; Business Administration and Accounting. Low tuition, low living costs. World famous for technical two-year courses. Those who lack high school may make up work. Students from all parts of the world. Located in picturesque hill and lake region of northern Indiana. Enter September, January, March, June.  
**2486 COLLEGE AVE. ANGOLA, IND.**

## A DUAL-MODULATED BEAT SIGNAL GENERATOR

(Continued from page 91)

modern broadcast station output. (External modulation may be used or the output of the audio oscillator may be used externally for A.F. tests.)

The operation of the unit is quite simple since all frequency ranges are directly calibrated on the tuning dial and for further simplification a range calibration chart is permanently fastened

to the top of the metal oscillator cabinet. The dial is of the vernier type; its 2 discs are calibrated in rough and fine variations which enable the user to obtain very close settings.

This article has been prepared from data supplied by courtesy of Clough-Brengle Co.

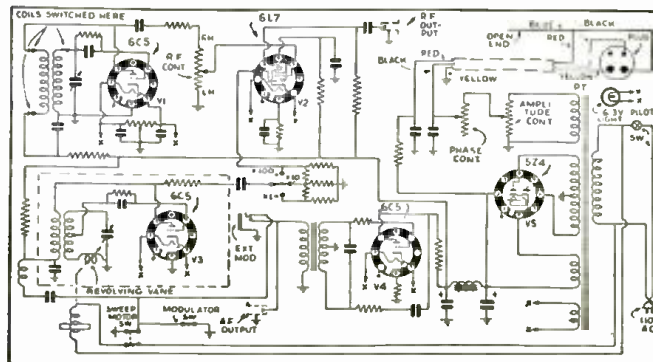

The circuit of the complete beat-frequency oscillator and frequency modulator (wobbler) for specific use with a cathode-ray oscilloscope.

Please Say That You Saw It in RADIO-CRAFT

## ELECTRONIC MUSIC FUNDAMENTALS

(Continued from page 90)

shutter being opened, the light energy from the mirrors passes through the moving tracks, through the apertures of the stationary mask, into the photoelectric element, for the conversion of light impulses into electrical energy and later into sound energy.

Figure 12 shows a close view of the pitch record and selective preadjustable mask.

(Part V will conclude the discussion of film systems, including photographic views of several models.—Editor).

**ADDENDUM TO PRECEDING ARTICLES.**  
The following letter was received from Mr. Leo L. Mesevage:

"In Part III of the article, 'Electronic Music Fundamentals,' in the June issue of your magazine the circuit diagrams of the different types of tone generators are incomplete and inadequate. For instance, in Fig. 8 the hookup to the amplifier is not shown. Also, in Fig. 9, the type of tube, the capacity of the condenser, the resistance value, etc., are not shown.

"In Fig. 10, the plans for the construction of the tone wheel system are also disappointing. The exact size of the phonic wheels is not given. According to the illustration there are 4 patterns of phonic wheels. Is the size of one pattern of the phonic wheel the same on each of the shafts? Are the pick-up magnets home-made? If so, what is the size of the wire and how many turns are there? All this and other information is necessary for the construction of an instrument.

"In the May issue of your magazine it was stated that in Part III the plans for the construction of the units C and D would be discussed. Well, I have read Part III, but I still do not understand the points in question."

Below we have Mr. Kassel's answer containing constructional details:

"Regarding your inquiry concerning Fig. 10 in 'Electronic Music Fundamentals' of the June, 1936, issue of *Radio-Craft*, additional information for the construction of a home-made electronic organ is as follows:

"Size of phonic wheels is not important, they can be from  $\frac{1}{4}$ -in. to 2 ins. in dia. It is important that they must be true on the shafts, preferably touched up by grinding.

"The phonic wheels must be made of soft iron or cold-rolled steel, press-fit on the shafts, or each having its own bushing with a set-screw.

"All shafts carry phonic wheels in duplication in size and in pattern. A row of one pattern of phonic wheels can be larger or smaller than the adjacent row of wheels.

"Thickness of the wheels is important, as is the cross-section of the magnet core. The longer (not wider) the gap between the wheel and core of magnet, the more A.C. is generated.

"Low-frequency coils on the pick-up magnet generate less current than high-frequency coils. In order to compensate for this, low-frequency coils must have more turns of wire than the 'high' ones. The size of wire is not important, practical sizes are Nos. 35, 33 and 28.

"Pick-up magnets are home-made and easily constructed. Permanent magnets are made of chromium magnet steel in annealed form. Better magnets made of chromium-tungsten magnet steel. For hardening glass-hard, heat steel bars to a bright cherry-red (1,550 deg.) and quench in water (water hardening steel).

"Use fibre washers to make coils, the kind that are used for spigots. Press washers tightly on the steel core and wind the coil, always in the same manner and in the same direction (for polarity checking use a compass).

"For magnetizing, use the core of a good dynamic speaker with the field turned on. By slapping one end of the steel bar with coil against the center of the speaker, the bar is easily magnetized.

"Assembling all magnets in a frame of the unit, adjust the gaps between the phonic wheels and magnet cores of the coils, by listening to the intensity of sound in the speaker or using a rectifier type of decibel meter for visual indication.

"More turns on the coil of the pick-up magnet produce high-impedance output and also cause trouble with key-click, while low-impedance coils (less turns) serve to the best advantage for transformer matching and in reducing key-clicks.

"The input (Amp.) transformer can be altered by the experimenter, with a primary winding (which must have several taps) with an impedance value of around 10 ohms, total, while the secondary must be matched to the grid of the tube of an amplifier.

"The pulleys on the shafts must be made true, as egg-shaped pulleys produce bad tones. The belt for the pulleys must be either endless, or spliced; and very long, so that the splice produces only slow beats (which are unnoticeable).

"The tremolo is accomplished by periodically loading and unloading the input circuit (change of volume), or by the Eremceff method, which consists of speeding and slowing down all shafts 4-7 times per second (change of frequencies).

"Amplification of A.C. from the pick-up magnets must be made with high-gain, standard amplifier. For 'swell pedal' use a standard volume control.

"For additional information on string amplifier art see the following patents.

- 1,002,036—1911, by Clement;
- 1,915,858—1933, by Meissner;
- 1,915,860—by Meissner;
- 1,915,859—by Meissner."

## THE RADIO MONTH IN REVIEW

(Continued from page 71)

the same thing can't be done in this country.—Editor).

The Pope has a new electronic star-controlled clock at Castle Gandolfo. The clock is adjusted by a photoelectric cell at the base of an astronomical telescope which sends an impulse when a certain star comes into focus of the latter and thus corrects any slight error in the clock's time.

In England, it is necessary to obtain an Artificial Aerial License before a radio transmitter can be built, even though it is never intended to use it with an aerial. This license is obtained without taking a test—which can be done later when the transmitter is ready to be connected to an honest-to-goodness aerial instead of a dummy antenna.

## SHORT CUTS IN RADIO

(Continued from page 87)

the analyzer plug. A screw-eye is used as a lifter and as a locator to get the holes correctly centered. No ridge is necessary on the center-pin. The disc should of course be made of metal—steel being preferable, as the tool will last longer.  
E. KULLANDER

## HONORABLE MENTION

**TESTING FILTER CIRCUITS.** An adapter should be made, a simple way being shown in Fig. 8, so that a type 80 rectifier may be placed in a socket normally using a 5Z4. When testing a receiver, in which it is suspected that the filter system is shorted, insert the 80 with its adapter. A short will cause the plates of the 80 to turn red, or a milliammeter test may be made. The 80 will stand such an overload for several minutes while the 5Z4 immediately shorts.  
V. V. NILES

Please Say That You Saw It in RADIO-CRAFT

# RADIO SERVICING "In the Car"

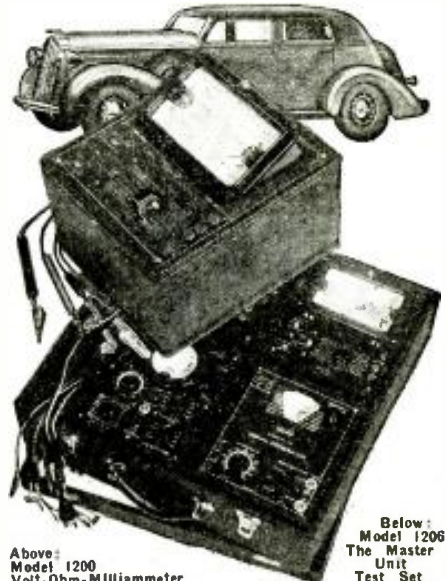

Above: Model 1200 Volt-Ohm-Milliammeter Dealer Net.....\$21.67  
Below: Model 1206 The Master Unit Test Set Complete Dealer Net \$84.33

Practically all makes of auto radio sets today are accessible for "in the car" servicing. Triplet Master Units are just the instruments for this work.

Small, light, compact, each Master Unit can be handled right where it is needed, doing the job easier and quicker.

The Triplet Master Unit Test Set is the most popular tester among radio servicemen. It is a complete portable laboratory with the testers that the professional serviceman needs in his daily work. Each instrument can be purchased separately and the entire laboratory thus built up over a period of time.

	DEALER NET
Model 1210-A Tube Tester.....	20.00
Model 1220-A Free Point Tester.....	10.00
Model 1231 All Wave Signal Generator, D.C. ....	26.67
Model 1232 All Wave Signal Generator, A.C. ....	26.67
Model 1204 Leatherette Carrying Case with Demountable Cover.....	6.00
Model 1207 (same as Model 1206 except has A.C. Signal Generator No. 1232) ..	84.33

See your jobber.

Write for Catalogue.



Triplet Electrical Instrument Co.  
168 Harmon Dr., Bluffton, Ohio

Without obligation please send me—  
—More information Master Unit Test Set.  
—New 1936 Catalogue.

Name .....

Address .....

City ..... State.....

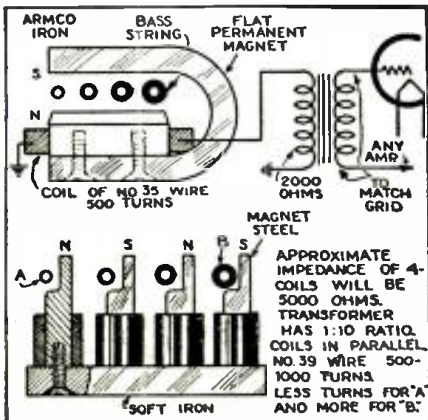
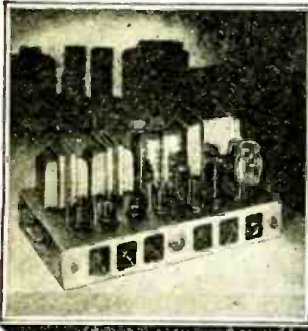

Fig. 13. Details of the pick-up magnets.

# NEW BEAM POWER AMPLIFIER



Here is the new, sensational and revolutionary 60 watt high-fidelity Anti-Howl ACA Beam Power Amplifier—the last word in sound equipment. It employs the new 6L6 high power output tubes, 6L7 volume expander, and 6E5 cathode ray expansion and output indicator—yet offered at a price within the reach of all. *Guaranteed for five years.*

Send for FREE Circular No. 836 describing our complete line of ultra-modern amplifiers. Dealers, Jobbers, and Distributors: Write for attractive proposition. Mr. A. C. Shaney, will gladly help you plan any type of P. A. installation. Send complete details for free expert advice.

**AMPLIFIER CO., of AMERICA**

AMPLIFIED SOUND SYSTEMS

20 WEST 22ND STREET NEW YORK CITY

## SET BUILDERS

The September issue of RADIO-CRAFT will be your special issue—written to give you the latest circuits and data on set, amplifier direction finder, etc., construction. Don't miss it!

## JOBS & CAREERS

THE VOCATIONAL DIGEST

**Tells You How to Go About**

WHEN YOU ARE TACKLING THE JOB OF FINDING A JOB;  
WHEN YOU ARE PLANNING A CAREER;  
WHEN YOU WANT TO BETTER YOUR POSITION.

On all newsstands. 25c.

If your dealer cannot supply you, send a quarter and we will forward a copy at once

**JOBS & CAREERS**

520 N. Michigan Avenue, RC-836, Chicago, Illinois

## SUPREME Velocity MICROPHONE

The new Supreme Velocity microphone is an all-purpose microphone, designed to be used wherever high quality is essential. With a curve which is flat over the entire audio frequency range, it assures maximum fidelity from all associated equipment.

**NOTE THESE FEATURES—Output level: -51 db. Frequency range: 30-15,000 c.p.s. Cable: 20 ft. Special low capacity shielded. No frequency discrimination. No hum pick up due to thorough shielding. Dimensions 6 1/2 x 2 1/2 x 2 1/2 inches. Thread standard 5/8-27 inches. Housed in a beautiful bronze-back case and may be had in all standard impedances including High Imp. List \$40.00. NET TO DEALERS AND SERVICE \$21.60 MEN**



Jobbers Write for Our Interesting Store Proposition and Sales Territory.

**SUPREME SOUND LABORATORIES**

20 Liberty St., Washington Hts. Newburgh, N. Y.

## RADIOS..SAVE UP TO 50%

DEAL DIRECT, Factory Prices. Many models to select from: AC-DC, All wave, Farm, Car and new Metal Tube Models. Your name and address on postcard brings you NEW 16-page 1936 Bargain Catalog in colors FREE. Get details of 30-day TRIAL plan and Agent-User propo. from Goldstone Radio Co. Dept. 301 8780 Grand River, Detroit, Mich.

30 DAY TRIAL \$6.98

Free Catalog

## RADIO ENGINEERING,

broadcasting, aviation and police radio, servicing, marine radio, telegraphy and telephony, Morse telegraphy and railway accounting, taught thoroughly. Engineering course of nine months' duration equivalent to three years of college radio work. All expenses low. Catalog free. School established 1874.

Dodge's Institute, Hudson St., Valparaiso, Ind.

## BOOK TELLS ALL! MODERN RADIO SERVICING

Get Free Circular Now

RADIO & TECHNICAL PUBL. CO.

45 Astor Place, N. Y. C., Dept. RC86

## TELEVISION ON THE WEST COAST

(Continued from page 76)

the Director of Television for the Don Lee Broadcasting System. Using his basic patents on scanning synchronizing processes, operation of the receiver away from city electric light mains was thus made possible.

A console-type television receiver was installed in a Western Air Express tri-motored plane, in which two flights were made with reporters and photographers. An image 8 ins. square was clearly received in spite of the plane's speed of 120 miles per hour. The image was transmitted from W6XAO, then operating on 44,500 kc. The ruggedness and reliability of cathode-ray television was thus demonstrated. The receiver withstood the shocks of take-off and landing 6 times.

Broadcasting Earthquake Scenes. Subsequently, on March 14, 1933, motion pictures of a major disaster were transmitted to the nation by television for the first time, when W6XAO broadcast scenes of the Long Beach-Compton earthquake area within a few hours after the tremor.

Scenes of the debris, survivors, wrecked buildings and the general havoc were included in this unusual television broadcast, the event presaging a new era in the speedy distribution of such scenes in the future when perhaps thousands of homes throughout the nation may not only hear of disasters, but witness pictures soon after the catastrophe has occurred.

Football Scenes Broadcast. Reception of the Stanford-University of Southern California football game on Armistice Day, 1933, was reported to the Don Lee Broadcasting System, only 3 hours and 45 minutes after the close of the game, by Mr. E. D. Erickson, who received the images at 1117 Venice Boulevard, Los Angeles. The game, which was recorded on motion picture film, ended at 5 p.m. At 8:45 p.m. that same evening the film was run off on the television. This is believed to be the shortest time in which timely football scenes have ever reached the television screen. This unique television broadcast presages the "evening summary" type of program which gives the late news at a time when the head of the household and others are able to view it.

### TELEVISION RECEIVER DATA

While no definite information can be given, now, regarding the "best" type of receiver to use for television reception, due to the lack of experience in this line, the following will be of help to experimenters.

For preliminary experiments in receiving W6XAO, any type of receiver which will tune to 6 2/3 meters may be used. Receivers designed for 5-meter amateur work are suitable when provided with slightly larger coils. Install coils with 50 per cent more turns and remove one turn at a time while tuning for W6XAO. A

simple line image of constant intensity is broadcast for a short period of each schedule, and an appreciable change in its strength after a change in the circuit or operation of a receiver is a direct measure of the effect of the change.

For receiving the images of W6XAO, the receiver must tune very broadly and should be of the superheterodyne type, with band-pass I.F. transformers arranged to operate on an I.F. of approximately 8,000 kc.

The new RCA type 954 or 955 "acorn" tubes are recommended for use in circuits carrying ultra-high frequency radio energy, except for the first-detector of a superheterodyne receiver, where the 6L7 metal tube is recommended.

Plate resistors in the detector and television-frequency amplifier must not be greater than 10,000 ohms. (This figure has been verified.—Editor)

The antenna for the receiver should consist of a thin copper tube about 1/4-in. in dia., or a thick copper wire which is 10 ft., 3 3/4 ins. long. This is a half-wave antenna for 45,000 kc. This may be attached to the receiver at one end through a small condenser, or may be cut in the center, held apart by an insulator, and a 2-wire, parallel, 70-ohm "lampcord" type of feeder joined thereto, one wire to each of the antenna halves at the insulator. The 2 wires of the feeder at the receiver end are connected to a 2-turn coil which is coupled to the first coil of the receiver.

As has been the case with certain other television activities, much of the work of the Don Lee Broadcasting System has been done behind closed doors. The work is carried on by a separate staff which devotes its entire time to television.

This station, however is one of the few in the U.S. which has been actually transmitting views during the past few years. Much practical experience has been gained from this experimental work and since the equipment has been kept strictly up to date, W6XAO will be ready when "chain" television arrives.

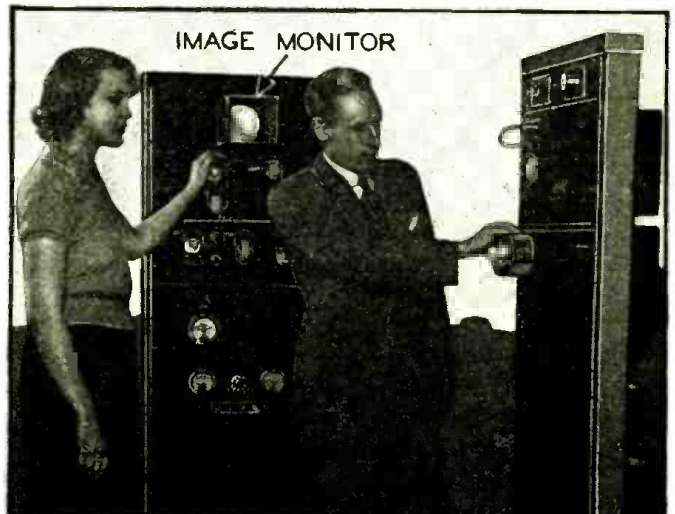

H. R. Lubcke explaining equipment at W6XAO. Note the cathode-ray image monitor.

Please Say That You Saw It in RADIO-CRAFT



# THE DESIGN OF MODERN TEST EQUIPMENT

(Continued from page 92)

pins are numbered from the key ridge of the bakelite guide pin. Looking at the base of an octal tube, with the guide key uppermost, the pins are numbered consecutively in a clockwise direction, beginning with the first pin clockwise from the guide key.

Aside from the established practice of using the No. 1 pin to terminate the metal shield and the No. 2 pin as one of the filament or heater pins, the other filament terminal may be the top cap or any pin from No. 3 to No. 8. This means, that, if a single 8-hole socket is to be used in which to test all elements of all octal tubes, it is necessary to select the contact of the octal tube to which the one side of the filament potentials may be applied, in addition to selecting the filament or heater potential to be applied; otherwise, a separate 8-hole socket or adapter would have to be added for each new pin combination.

The filament or heater circuits terminate at what are known as the pins numbered 2 and 7 on the octal tubes which were included in the preliminary announcements of metal tubes. Subsequently, the metal tube type 5Z4 was announced with a filament circuit terminated by pins numbered 2 and 8, and a later type 6P7 was announced with a heater circuit terminated by pins numbered 2 and 3, so that a tester socket in which the filament or heater potentials are applied to the contacts numbered 2 and 7, only, cannot be used for testing the later types in which the filament is terminated by pins numbered 2 and 3 or 2 and 8.

If the "Filament Return Selector" switch, shown in Fig. 8A, or its equivalent, were not used, three 8-hole sockets would be required to enable a test of all of the elements of the first few octal tubes already in use; it would be possible for the user to insert an 8-pin tube in the wrong socket, and the tester would be partially obsolete in the event a metal tube were announced in which neither pin numbered 3, 7 or 8 were used as one of the filament or heater pins. Hence, the advisability of using a "Filament Return Selector" switch through which the filament or heater current, which may be considered as entering the No. 2 pin of the octal tubes, can return through the "top cap" terminal or through any one of the numbered pins of such tubes. By using this switch, no adapters are required, and only one 8-hole socket is needed for all present or future octal tube types in which the filament currents may return through the top cap terminal or through any pin other than the number 2 pin through which the filament or heater currents may be considered as entering octal tubes.

Variations in power supply potentials may be compensated (1) by means of a power rheostat in the primary circuit, or (2) by means of a tap switch used with a tapped primary transformer winding. When a rheostat is used, the unwanted power is dissipated in heat losses, and the rheostat must be re-set for each load imposed by a tube test. The tapped transformer arrangement, which is more expensive in original cost, is more economical in operation, and does not

require a re-setting operation for each tube test load, is used with the tested circuits under discussion. A type 01A tube is used as a rectifier tube in series with the meter for power supply adjustments. Since the rectifier load is only 0.005-A. (½-milliampere), the tube is never overloaded and should last indefinitely.

## ELECTROLYTIC CONDENSER LEAKAGE TESTER

The condition of an electrolytic condenser is indicated on a "Good Capacitor—Bad Capacitor" scale, which is connected into a circuit arrangement indicated in Fig. 8B. The required D.C. potential is supplied by the self-contained rectifier tube and filter arrangement through the resistance R, which limits the current to a safe value for good condensers and protects the meter against short-circuited electrolytic units. Our engineers originated the English-reading electrolytic condenser leakage test which will probably be copied in competitive designs later on.

For electrostatic (paper) condenser leakage tests, the tester circuits are resolved into the scheme suggested by Fig. 8C. The required D.C. potential is supplied by the self-contained rectifier tube. After the initial surge through an "unknown" condenser, there should be no current through the neon lamp unless there be a leaky or short-circuited condition within the unknown unit to pass direct current. If the unknown condenser is short-circuited or if it has very low D.C. resistance, one element of the neon lamp will glow continuously, indicating the presence of a direct current through the unknown condenser. If the unknown condenser is not short-circuited, but has a high-resistance leakage, the leakage resistance will periodically discharge the accumulated charges of the known unit, C, through the neon lamp and the rectifier tube, so that the presence of such a leakage within the unknown unit will be indicated by intermittent glows of one element of the neon lamp. This arrangement is the best known practical method for indicating leakages in electrostatic (paper) condensers.

## SUMMARY ON TUBE TESTING CIRCUITS

In Part IV, we discussed the development of the individual tube testing circuits. By referring to Fig. 9 we see the complete master tube testing circuit combining the component circuit as discussed herein.

It will be noted that this circuit includes a resistance measuring and a D.C. voltage measuring circuit as explained in Part I.

*Thus, we have given, to the best of our knowledge, the most complete explanation of modern tube testing and analyzing circuits heretofore published!* The development work in this line cannot help but make many forward strides in the next few years if the modern test instrument, compared to the old "Filament Checker" and D.C. voltmeter of 10 years ago, is any indication.

*This article has been prepared from data supplied by courtesy of Supreme Instruments Corp.*

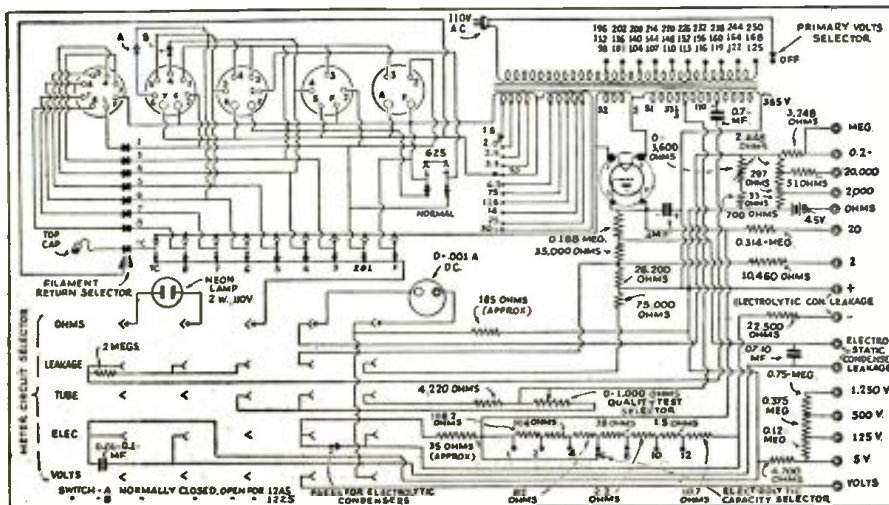

Fig. 9. The circuit of the complete tester described.

Please Say That You Saw It in RADIO-CRAFT

# THE SYLVANIA TECHNICAL MANUAL



## IS GOING GREAT GUNS!

Every day from every corner of the world . . . more orders are coming in for the New Sylvania Technical Manual. And no wonder! Radio men have discovered that here is a real VALUE! Look at some of the subjects covered in this book:

1. 141 tube types listed with important circuit application information given on each type.
2. Characteristics on all types completely up-to-date. This includes all standard types of metal tubes.
3. Section on circuits has been increased to include 13 typical radio receiver and amplifier circuits which show proper use of the most popular types of tubes now being employed.
4. Curve data on ballast tubes for battery sets.
5. A 50% increase in contents.
6. The convenient pocket size has been retained in spite of the large increase in material.

**Don't miss this value! Send 15c for the New Technical Manual NOW!**

Hygrade Sylvania Corporation, makers of Sylvania Radio Tubes and Hygrade Lamps. Factories at Emporium, Pa., Salem, Mass., and St. Mary's, Pa.

# SYLVANIA THE SET-TESTED RADIO TUBE

Hygrade Sylvania Corporation BC-86  
Emporium, Pa.  
Please send me the new Sylvania Technical Manual  
I enclose 15c in stamps.

Name .....

Address .....

City .....

State .....

## REFLECTIONS OF A SERVICE MAN'S WIFE

(Continued from page 85)

**DEPEND ON DUMONT OF QUALITY PRECISION**

**Built for You At a Price You Can Afford!**

The DuMont Model 154 Oscillograph has been aptly called the Featherweight Champion of the Industry. It's the kind of an instrument Service Experts are proud to own! DuMont exclusive features and built in quality make it the best buy in the industry. Check the DuMont claims of superiority. Write for complete data. You can't afford not to know!

**GET FULL DETAILS**

Industrial Plants and Colleges Have Made DuMont Their Standard

Write Dept. 836

Allen B. DuMont Labs., Inc. Upper Montclair, New Jersey

## TYPEWRITER BARGAIN

10-DAY FREE TRIAL OFFER

FREE HOME TYPING COURSE



ONLY 10¢ A DAY

BRAND NEW MODEL No. 5

## REMINGTON PORTABLE

● A brand new Remington for only 10¢ a day. An easy, Practical Home Typing Course FREE. With it anyone quickly becomes expert on this machine... the most rugged, dependable portable made. Not used or rebuilt. Standard 4-row keyboard. Standard width carriage. Margin release on keyboard. Back spacer. Automatic ribbon reverse. Every essential feature of big office typewriters. Carrying Case FREE. Try it for 10 days without risking a cent. If you don't agree it is the finest portable at any price, return it at our expense. Don't delay. Without obligation, write now.

REMINGTON RAND, INC.,

205 East 42nd Street, Dept. 189-B, New York, N. Y.

### DEALERS! SERVICEMEN! SOUND SPECIALISTS!

Send for your copy of our FREE catalogue No. 127, chock full of PUBLIC ADDRESS AND SOUND EQUIPMENT at prices which you cannot afford to miss.

PRECISION SOUND LABORATORIES

Dept. B8

126 LIBERTY STREET, NEW YORK, N. Y.

## OXFORD NEW SPEAKERS

... with "Changeable Fields" and Universal Transformer, bring you new convenience, performance and economy in Speaker Replacements. Ask Your Jobber or Write today for Bulletin 361C.

OXFORD-TARTAK RADIO CORP. 915 W. VAN BUREN ST. CHICAGO, U.S.A.

"honest" is somewhat interesting—should the customer need the set badly enough to throw out the \$10.00, which he must—in a city "100 per cent organized."

This organization is constantly held up as a model upon which organizations should be built. They are lauded as instigators of the "flat rate" supposed panacea for what is wrong with radio service. They are attackers of the free examination man on the ground that he is a crook who gives away his labors. Mayhap they coined the thought "A Workman Should Be Worthy of His Hire."

Pity we couldn't take a peek into the record! It ought to prove interesting as well as enlightening to secure a bona-fide list of all service work performed in that area, together with the sum total of money received, and divide it equally among the supposed number of radio men engaged—and come to some conclusion as to who, if any, was worthy of his hire then.

In many cases, it would be found they were not only giving their work away. They should be willing candidates for the ditch-digging jobs so slightly spoken of in the advertisement.

The greatest error any organization can make is the laying down of hard and fast rules regardless of the community it serves. In radio—it is the posting of a flat rate. The uncompromising exaction of an inspection fee. The limiting of a man's earning power by decreeing that the expert shall earn only as much as the ineffect. Destruction of initiative, without which progress in any field is brought to a standstill.

No hard and fast rule can apply to anything so individual as the quality and sort of a man's labors. There is something within himself which regulates how great or small he shall be.

At a meeting of Service Men in this city some time ago, a nationally known engineer, publisher of a service manual and ardent exponent of Organization, when pressed, admitted that a Service Man could not expect to charge as much for repairing an inexpensive set as he could for repairing a Stromberg-Carlson for instance. A contradiction which in itself would indicate that latitude is needed in the matter of price-fixing alone.

Let us consider the argument—"it takes no more than a few minutes to replace a bypass condenser in the average set"—the flat rate for a bypass being \$1.25, regardless. Consider also an ancient Majestic 60 (there still are a few rambling around)—or some similar model with a 0.1-mf. shorted in the intermediate. When the Service Man upon whom this set falls gets through melting tar (!), replacing condenser, assembling, testing, aligning chassis—he has valued his labors at less than a coolie's. And the coolie has no overhead either.

Even among the lauded medical profession a physician sets his own charge for any operation he may perform. One physician may charge \$25.00; another \$50.00; another \$1,000.00—all for the same operation. Some get nothing. But physicians do not rise to revile each other because their prices differ. Radio men, it would seem, rise and revile each other whatever they charge. The other fellow either charges too much or too little. His sin rests primarily in being the other fellow.

This squabbling and burbling among the clan is going to cease being a private family row and leak out the cracks to the public before long. Then the radio service industry will indeed have dealt itself a round black eye.

Whenever there is anything particularly wrong anywhere it is human nature to select someone or something to ride on a rail. Theoretically justice is so served. To date it would seem that the "free examination" man is the goat. But the "free examination" man is a very minor factor in what is wrong with radio today.

To say that all "free examination" men are dishonest is making so broad a statement it is ridiculous on the face of it.

Because some "better business" bureau started a cleanup of its own conditions and found—among others—that a number of "free examination" men were dishonest—many an opportunist, thousands of miles away, seized upon the chance to preen.

The article treated very lightly of the man who "service" charged, but damaged the set still further as a parting shot.

Not even a better-business bureau is within its legal rights in causing the just to suffer equally with the unjust. It has a poor conception of the word "protect" if it deals with generalities and not specific instances. Wherever it finds proof of malpractice it should make known the facts and bring the offender to justice. But should first make sure it has the right offender.

To forbid a man not to not make a charge is the height of absurdity. If it is indeed true that such a body has forbidden a man to furnish an estimate on his labors such a request most certainly did not come from the public in whose interest it was organized! Here I speak from the viewpoint of any customer, anywhere.

It is as ridiculous as the barring of lolly-pops to children by local barbers. The barber who furnishes a lolly-pop as an adjunct to a Dutch-cut is a crook and a shyster. But try to make the kids object!

To show how fallow is the human mind, the bubble is being floated that were the "free examination" man exterminated root and branch the industry would become as the lily. The inspection charge would automatically create an honest man. Or a talented one. Not so. A skunk is a skunk in any guise. He may take on the habiliments of a gentleman, but the strain of being one is often too great, and eventually he will show the stripe up his back. Let me assure you, ye brethren who toil by the analyzer and soldering iron, you are not the only ones to resent his presence. John (but especially Jane) Customer has his own proboscis.

Free examination may be followed with honor and profit. If an organization finds it practical as well as profitable to furnish an estimate on its work it should be absolutely its own business. It is in other businesses. Common sense is an ideal factor. In communities where to cover territory a Service Man would need an airplane instead of his usual venerable ark, no one but a radiant optimist would attempt it.

Too much stress is laid upon the service charge anyway.

Anyone with a dither of sense will agree that profit lies not in the nominal sum at best that can be exacted for an examination, but in the number of real jobs, or aggregate of small ones, that come his way. A galaxy of door-bells would have to be punched at a dollar a punch if the service charge alone could be counted on to maintain the upkeep of even a mediocre staff—to say nothing of overhead.

Often I have heard it said—a radio Service Man must learn his trade; why should he go out and impart his knowledge to the layman that the layman depart and doctor himself? Even if every Service Man everywhere should suddenly become a lot more truthful than he usually is and tell the customer the plain unvarnished truth about what ails his radio—the average layman would still be at loose-ends. Even if he were to try his hand at self-medication—the job would almost certainly be the Service Man's. So what?

The Service Man is primarily out to sell his work. To view the customer in the light of "sucker" is not and has never been good business. When a Service Man exacts a fee for displaying his wares, it would seem he has something to fear; and he leaves a bad taste behind him if he walks out with a dollar and leaves nothing to show for it. If his work is good and his prices fair he will invite comparison, and gain more than he will ever lose in time and gasoline.

After all—if it were your radio set—your crumpled fender—your leaky roof—your hard-earned cash—what would you do? You're telling me!

The real mote in any Service Man's eye should be those misleading statements whereby the public is led to believe that for little or nothing (usually the price of the inspection or "tune-up" [!] fee) their sets can be put into repair. Advertising is a great and wonderful medium, when properly utilized. The man who advertises consistently lugs home the bacon. The letter mouse-trap in the middle of the wood is OK in theory but a dud in reality. Repairing radio sets can be made as attractive to the public as any other commodity. In fact it must be. But let it be truthful.

Just as a real Service Man takes pride in his labors he places equal importance upon the

Please Say That You Saw It in RADIO-CRAFT

quality of materials he uses. No shoddy parts or seconds are used, to return like Banquo's ghost to haunt his sight. He does not pass as "good enough" any set about which there is any question. The dyed-in-the-wool radio man will stick with a sticker until there is no question that it is right. That man indeed is worthy of his hire!

I firmly believe all repairs should be strictly c.o.d. It is unfair to the man who specializes in service to find it necessary to compete with department stores and nit-wits in general who repair on the installment plan. Such tactics demote specializing in service to a point that removes all semblance of profit. A Service Man should not have to be an installment collector. Having to make repeated calls to collect and many times not collecting them should call forth the only hard and fast rule I can see any logic in—c.o.d. to the devil himself!

Another natural enemy of the qualified Service Man (I quote) is the blankety-blank wholesaler who has a foot in both camps; runs with the hares and hunts with the hounds—so to speak. He sells to Service Man and consumer alike at the same price—not aloud, perhaps, but nevertheless. Into his shop can walk any Tom, Dick, or Harry and buy the part at full discount. He repairs for dealer and public both. Pats the Service Man on the shoulder and knifes him in the back. The consumer can tell the Service Man where he can buy the part and for how much. Why should he pay him more? He shouldn't, for a fact.

I have never purchased a single gadget for a radio receiver. In fact, I have a distinct distaste for radio parts in general. I prefer the esthetic phase, absolutely, but—

I do believe wholesalers should stick to their own side of the fence and gather their roses from their own legitimate clientele. We wives of radio have enough of the prima donna in our mates to contend with as it is.

We wives to whom radio has meant so much—who have seen it grow up as it were—and, like the farmer's wife who nursed many a sick chicken beneath the kitchen range, have nurtured many a convalescent set on the refrigerator—are loath to see the grand old game to which

we donated so much of our loyalty and maybe a gray hair, fall into evil days for lack of a little renovation.

Must it become as dead as the dodo-bird—something fabulous of which to tell our great-grandchildren?

Ask not the radio men themselves! They are too near to the subject; as near as to the tools they cannot see when they lie beneath their noses. The air they breathe in is too rarefied; that which they expel too frequently too sulphurous for calm, careful, logical consideration.

The radio service industry should and must organize if it means to survive. *But organization should first be local; then national.* Organization within organization is what is necessary. Fitted to communities; meeting sectional requirements. The right material must be assembled in the first place, with aspirants closely studied as to ability. No farcical so-called examination by mail. No "fathering" by some manufacturer with an eye to pushing his product. Instead, honest-to-goodness examination both practical and theoretical by some licensed examiner at some specified time and spot.

That is the only way, to my thinking, that wheat can be successfully separated from the tares and the field cleared of over-crowding. Make being a member of such an organization not the jest it seems to be but an honor and a privilege. Make impossible the card of entry to the gate-crasher and poseur.

That when some future airy commentator holds forth on what he kens so little of—the real merits of a real Service Man—it will not be necessary any longer to use your sleeve to smother your curses.

At last you can agree with him.

This survey of the radio service field is presented to prompt, if possible, an honest discussion of the subject, by our readers. It is printed just as the author wrote it, without revision and thus is the opinion of one person. However, there is much truth in the statements made and while we may disagree about some minor details, it must be admitted that the story is true in all major points.—Editor

### AN IMPROVED TELEVISION CAMERA

(Continued from page 92)

#### METHOD OF INTERLACED SCANNING EMPLOYED BY FARNSWORTH

Much of the improvement in picture detail is due to the new method of interlaced scanning employed. If beyond a certain point the number of lines per frame be increased, the band of picture signal is increased without appreciably increasing the picture detail. Therefore, a method of effectively increasing the picture detail and reducing the flicker has been developed by doubling the frame frequency and letting the lines of alternate frames fall midway between each other. This method of scanning is called "2:1 even interlace" and is accomplished by impressing on the 60-cycle vertical deflecting frequency a 30-cycle oscillation of a magnitude just sufficient to change the amplitude of the 60-cycle oscillation by the space of 1/2 line in the vertical plane of the picture frame. This causes the "odd" and "even" lines to fall in alternate positions every 1/60-sec. Thus, if 350

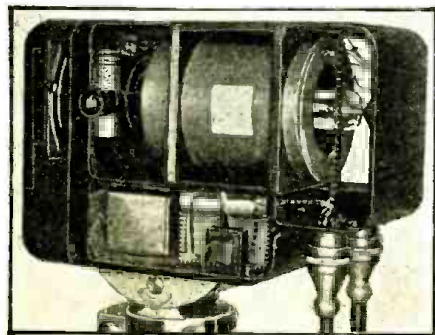

Fig. 8. The interior of the camera.

lines are in every complete frame (1/30-sec.), there will be 175 "odd" lines on the frame the first 1/60-sec., and 175 "even" lines on the frame the second 1/60-sec.

The difficulty of maintaining such a scanning pattern is dependent on the accuracy of the 30-cycle oscillation impressed on the vertical deflection frequency. If the amplitude of this wave changes, the spacing between interlaced lines will vary, thus destroying the scanning pattern. At the present time, experiments are being conducted employing either 350, 441, or 450 line frames. It is quite possible that a system employing 450 lines per frame will be the ultimate result.

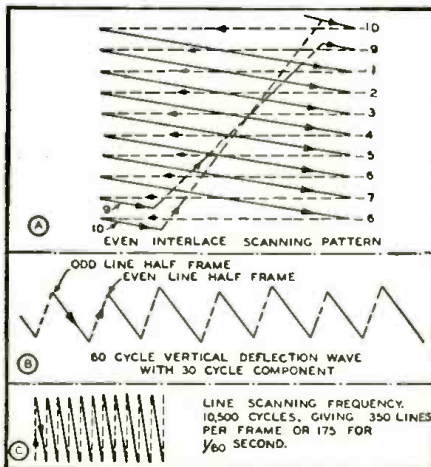

Fig. 1. The method of interlacing the lines.

Please Say That You Saw It in RADIO-CRAFT

# HAIL...THE



NEW  
POCKET D.C.  
VOLT-OHM.  
MILLIAMMETER  
MODEL 735



DEALER  
PRICE  
**\$10.80**

- ★ Accurate to 2%
- ★ Molded Case
- ★ Selector Switch
- ★ With Test Leads and Two Alligator Clips

### A SENSATIONAL DEVELOPMENT AT A SENSATIONAL PRICE

Here is the handy, general purpose instrument you have always wanted . . . Precision built, D'Arsonval movement . . . Accurate . . . At the unbelievable price of \$10.80.

Slips in the coat pocket, provides all the D.C. measurements required by the radio serviceman. The selector switch makes operation as simple as the larger multimeters.

Reads D.C. 15-150-750 volts at 1000 ohms per volt; 1.5-15-150 Milliamperes; 5-1000 low ohms; 0-100,000 high ohms at 1.5 volts.



Readrite Meter Works  
816 College St., Bluffton, Ohio  
Please send me more information on the Ranger-Examiner.....

Name .....

Address .....

City ..... State .....

*Again...*

**AMPERITE LEADS WITH 2**

**ADVANCES IN MICROPHONE ENGINEERING**

**1 New! EXTERNAL INPUT TRANSFORMER** (Cable type Model LGP)  
NOW ENABLES USE OF LOW IMPEDANCE MICROPHONE WITH AMPLIFIERS HAVING HIGH IMPEDANCE INPUT  
Up to 2000' of cable can be used  
Hum trouble is entirely eliminated by special balanced windings. Extra heavy case will withstand mechanical abuse. Not to be confused with ordinary input transformer.

**2 New! DUAL-IMPEDANCE MICROPHONE** MODEL (RB DE)  
FOR LOW OR HIGH IMPEDANCE AMPLIFIERS  
Can be used with high impedance input with cable lengths up to 125' or low impedance input with cable lengths up to 200'. **USE PLUG IN THE PROPER CABLE** as shown in diagram. **NO DEAD WINDINGS OR TAPS**—therefore maximum efficiency for low or high impedance connection.

*Again?*  
Yes, Amperite was first to use Microl Alum minimum Magnetoresistance with a successful "Topol" velocity... Best with a high impedance velocity... Best to bring velocity type microphone within reach of all.

**AMPERITE Company** 361 BROADWAY, NEW YORK.

**AMPERITE velocity MICROPHONE**

**KATO LIGHT JR.**  
Complete light plant at price everyone can afford  
**LIST PRICE**  
6 v. 150 watt D.C. \$59.95  
12 v. 200 watt D.C. 62.00  
32 v. 300 watt D.C. 65.00  
110 v. 300 watt D.C. 69.00  
110 v. 300 watt A.C. 84.00  
Profit for dealers.  
Kato Engineering Company  
Mankato, Minn., U. S. A.

**ANY CARBON MIKE REPAIRED**  
Includes replacement of damaged diaphragms and reworking of both buttons with best grade of granular carbon. Both buttons are scientifically matched for like impedance. Genuine acid-leaf gold spot contacts furnished. 24 hour service.  
**\$3.00**  
MICROPHONE REPAIR SPECIALISTS  
159 6th Ave., New York, N. Y.

**"HAM" SPECIAL Standard Teleplex**  
A highly efficient code teacher using heavy specially prepared waxed paper tape, having two rows of perforations. Write for Free folder AS. We are the originators of this type instrument.  
**TELEPLEX CO.**  
72 Cortlandt St., N. Y. C.

**RADIOS AT A GREAT SAVINGS BUY DIRECT**  
Many models to select from. Factory prices.  
**THIRTY DAYS TRIAL**  
A.C.-D.C. All Wave, farm, car, and new metal tube models. Public Address and Communication Systems. Send for new 1936 bargain catalog free.  
**FREE CATALOG**  
**AUTOCRAT RADIO COMPANY**  
3855 North Hamilton Avenue Dept. 258 Chicago, Illinois

**Attention... SERVICEMEN!**  
Why not write today for full free details on Sprayberry Advanced Service Training? We have helped hundreds of servicemen to greater success. We believe we can help you, too. It will cost you nothing to investigate.  
**SPRAYBERRY ACADEMY OF RADIO**  
2548 University Pl. N. W., Washington, D. C.

**HOW TO MAKE AN OSCILLOSCOPE**

(Continued from page 93)

water would only have to travel 6 ins. from bottom to top. Therefore, we would be able to fill the pail 8 times in 1 minute instead of 4 as in the previous case. In other words, we have doubled the frequency and cut the amplitude in half.

The water slowly filling the pail to the top represents the voltage, which is slowly moving the electron beam across the screen. Assume, as before, that 15 seconds is required to move the luminous spot across the screen a distance of 2 ins. At the end of the charging-current cycle, the electron beam is instantly returned to its former position and a new cycle starts. Of course, in practice, the spot always moves across the screen faster than 10 times in 1 second, thereby producing a solid horizontal line extending across the screen. That is, with no voltage applied to the vertical deflector. But when any voltage is applied to the vertical input jacks, the electron beam will move up or down or both, as well as sideways, thus producing an image which has all the variations of the voltage itself.

Now, before we proceed with the constructional details pertaining to the addition of the sweep circuit, we want to make it clear that the complete oscilloscope has a pair of type 57 amplifiers which are used to increase the input sensitivity of the 906 to a point where 2 V. input will cause a 1 in. deflection on the screen. Without these amplifiers 75 V. would be required to obtain the same 1 in. deflection.

The vertical amplifier may be omitted until later but the horizontal amplifier circuit is so interwoven with the sweep-oscillator circuit that it was deemed best to include it in this issue. The additional parts required for the vertical amplifier are few and have been included in the parts list.

**CONSTRUCTION**

First a 5-prong socket is mounted on the chassis, in the hole which was previously drilled for it. If no hole was provided in the initial construction refer to the chassis layout in last month's issue and follow specifications.

To the left of the 5-prong socket, mount the sweep input transformer. If the recommended transformer is not used, obtain a 1.1 ratio low-impedance audio transformer, having a D.C. resistance of about 1,000 ohms on both the primary and secondary.

Mount on the front panel, the following parts:—Facing the front panel, the top row of four 3/8-in. holes will be occupied by 4 switches. The extreme left hole is for the vertical-amplifier switch which is 1-gang, 2-pole, 2-tap.

In the next hole is mounted the sweep-frequency range switch which is 2-gang, 8-tap. Then comes the sweep-selector switch which is 1-gang, 3-pole, 3-tap. In the extreme right hole is mounted the horizontal-amplifier switch which is 1-gang, 2-pole, 3-tap.

The center row of four 3/8-in. holes is filled as follows:—Extreme left, vertical-gain potentiometer. Next, synchronizing-vernier potentiometer. Next, frequency-vernier rheostat and in the extreme right hole, horizontal-amplifier potentiometer. Neither gain control is mounted directly on the front panel, but a 1/4-in. shaft bushing is placed in the extreme left and right holes. Quarter-inch aluminum shafts extend from the front panel to the controls which are mounted on small angles placed very close to each amplifier tube shield.

A bakelite panel should now be prepared for the mounting of 14 bypass condensers. Eight of these condensers are 0.25-mf. The rest range in size from 0.1-mf. down to 500 mmf. It is suggested that this panel be mounted upright, midway between the front panel and the sweep input transformer. If this plan is followed, the leads from the sweep-frequency range switch to the 8 different condensers will be short and the wiring capacity will be very low. Two slots are cut into the panel for the passage of the two aluminum shafts.

Figure 8A shows the size of the panel and the recommended layout for the various condensers.

Figure 8B gives the dimensions for the sweep panel top shield. This shield prevents stray electrostatic fields, which may be produced by the condensers beneath, from affecting the electron beam, in the 906 directly above.

It is grounded to the front panel by fastening

it under the two black tip-jack lock-nuts. It also serves as a brace for the bakelite panel to which it is fastened and finally, it enhances the appearance of the "innards."

Figure 7 shows a rear view of the 4 switches together with the proper terminal designated. These special switches come with rather long shafts, which must be cut 1/2-in. from the start of the threaded shanks. Lock-washers should be used on all shanks to prevent future loosening.

Panel wiring above the base, which must pass through the chassis should be routed through the proper grommet in the row of three, directly behind the front panel.

By following Fig. 7 very carefully, the switch wiring may be done quickly and neatly. In fact, the switch wiring which will remain above the base may be left a few inches longer, to make it easier when the sweep panel is hooked up. The sub-base wiring is not difficult. Small bakelite terminal strips will help a great deal to produce a very neat and rugged wiring and resistor assembly.

The four 0.25-mf. condensers C7, C8, C9, C10, which were used in the first stage unit may be removed and placed on the sweep panel, if desired.

The wiring and parts required for both amplifiers are almost identical, that is, each amplifier has a plate resistor, R.F. choke, bias resistor, and condenser of equal values. The horizontal amplifier is wired first. If the additional parts needed for the vertical amplifier are at hand, there would be no point in waiting to add them later on.

This completes the wiring and as before, the circuits should be tested carefully for continuity, shorts and possibly poor soldered joints.

In next month's issue, we will describe in detail the operation of each control. We will also include the addition of the sides, top and bottom, to completely enclose the chassis.

**LIST OF PARTS FOR SWEEP CIRCUIT**

- \*One sweep selector switch, 1-gang 3-pole 3-tap, Sw.3;
- \*One sweep frequency range switch, 2-gang 3-point, Sw.2;
- One Centralab frequency vernier control, 2 meg., R15;
- One Centralab synchronizing vernier control, 1,000 ohms, R16;
- One RCA sweep input transformer, part No. 4847;
- One Eby wafer socket, 5 prongs;
- One RCA type R85 tube;
- Two Cornell-Dubilier tubular by-pass condensers, 0.25-mf. 400 V., C11, C12;
- One Cornell-Dubilier tubular bypass condenser, 0.01-mf. 400 V., C13;
- One Cornell-Dubilier tubular bypass condenser, 0.03-mf. 400 V., C14;
- One Cornell-Dubilier tubular bypass condenser, 0.01-mf. 400 V., C15;
- One Sprague mica postage stamp type condenser, 0.003-mf. 400 V., C16;
- One Sprague mica postage stamp type condenser, 0.001-mf. 400 V., C17;
- One Sprague mica postage stamp type condenser, 500 mmf., 400 V., C18;

(Continued on the bottom of page 115)

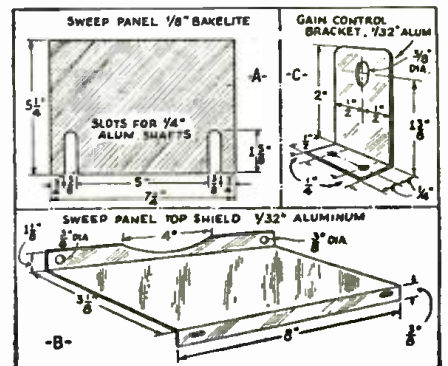

Fig. 8. Details of the sweep panel and its top shield; also the bracket for holding the gain control resistor.

Please Say That You Saw It in RADIO-CRAFT

## A CATHODE-RAY FILM SCANNER

(Continued from page 94)

cathode-ray beam, which is practically free of inertia. (The latter statement is the author's opinion and, as in this issue, is disputed by some writers.—Editor)

The principle of von Ardenne's method is shown in Fig. 1. At the left is represented the cathode-ray tube. At the right is a lens system and behind it the movie film to be scanned, and the photo-cell. The 4 deflecting plates of the cathode-ray tube are fed by time-base (sweep) oscillators. The lens projects the moving line of light from the luminescent screen onto the surface of the movie film. The light that issues from the other side of the film, the intensity of which depends exclusively upon the absorption power of the film, strikes the photo-cell and produces an electric current, the intensity of which is proportional to the transparency of the film element concerned.

The main difficulties with early apparatus were:

1. The inertia of the fluorescent substance at high frequencies.
2. Lack of light output.

In 1934, fluorescent materials were discovered which are practically free of inertia and have a sufficiently high light output.

Since scanning with 300 to 400 lines is required, considerable light intensity in the traveling spot is necessary. For this purpose v. Ardenne constructed a special type of a cathode-ray tube in which an anode potential of 25,000 V. can be used, speeding up the electrons sufficiently to produce an intensely bright spot.

The complete transmitting and receiving plant which von Ardenne has constructed together with Messrs. C. Lorenz A.-G., Berlin, is shown in block form in Fig. 2. The short line connecting the transmitting apparatus to the receiver represents the transmitting channel. This may be a wire or a radio carrier wave. In von Ardenne's laboratory set-up of apparatus it was a short wire.

The result achieved by v. Ardenne's apparatus excels in accuracy that obtainable by mechanical scanning systems.

## HOW TO MAKE AN OSCILLOSCOPE

(Continued from page 114)

- One Sprague mica postage stamp type condenser, 50 mmf. 400 V., C19;
- One Continental carbon resistor, 200 ohms, 1 W., R17;
- One Continental carbon resistor, 1,000 ohms, ½-W., R18;
- One Continental carbon resistor, 5,000 ohms, ½-W., R19;
- One Continental carbon resistor, 10,000 ohms, ½-W., R20;
- One Continental carbon resistor, 0.3-meg., ½-W., R21;
- One Continental carbon resistor, 0.4-meg., ½-W., R22;
- One Continental carbon resistor, 0.75-meg., ½-W., R23;
- Six Blan terminal strips, 6 lugs on each.

### VERTICAL AND HORIZONTAL AMPLIFIER

- Two Eby wafer sockets, 6 prong;
- Two Blan tube shields;
- Two RCA type 57 tubes;
- Two Blan grid caps;
- Two Centralab gain controls, 0.5-meg., R24, R25;
- Two Blan ¼-in. shaft couplings;
- Two Blan ¼-in. aluminum shafts, 8 ½ ins. long;
- Two Blan ¼-in. bushings with ¾-in. shanks;
- \*One horiz. amp. switch, 1-gang 2-pole 3-tap, Sw.4;
- \*One vert. amp. switch, 1-gang 2-pole 2-tap, Sw.1;
- Two Cornell-Dubilier tubular cond. 0.25-mf., 400 V., C20, C21;
- Two Cornell-Dubilier tubular cond. 0.004-mf., 400 V., C22, C23;
- Two Hammarlund shielded R.F. chokes, 80 Millihenries;
- Two Continental carbon resistors, 0.1-meg., 1 W., R26, R27;
- Two Continental carbon resistors, 850 ohms, ½-W., R28, R29;
- Eight Blan pointer knobs.

\*Names of manufacturers will be sent upon receipt of a stamped, self-addressed envelope.

# AGAIN - Kendall Clough presents a great new achievement in Cathode-Ray Equipment

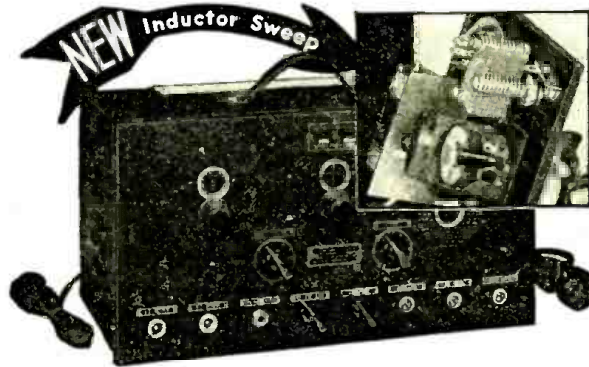

## The "INDUCTOR SWEEP" Frequency Modulated R-F Signal Generator

No rotating condenser—No impulse generator—No commutator

After two years of continuous research and field experience, this new method of frequency "wobble" has been developed. The copper disc, rotating in the field of the solenoid coil, provides uniform frequency sweep for all test frequencies. Eliminates all mechanical and electrical uncertainties. Ask your jobber to demonstrate or write for new announcement bulletin.

### Clip and mail today

Send at once new bulletin describing the "INDUCTOR SWEEP" Frequency Modulated R-F Signal Generator for use with the Cathode-Ray Oscillograph.

Name .....

Address .....

**The CLOUGH-BRENGLE CO.**  
1130 W. Austin Ave., Chicago, Ill.

## PRICE CUT 30%

On this Fine Receiver Made by McMurdo Silver

Silvertone  
PROFESSIONAL  
Superheterodyne  
Now  
**\$66.50**  
CASH

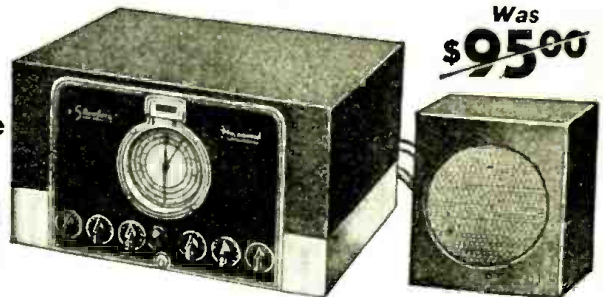

Was  
~~\$95.00~~

- Covers all five amateur 10, 20, 40, 80 and 160 meter and all S. W. broadcast bands—9 to 175 meters. No plug-in coils.
- Bliley crystal filter for single signal C. W. and super-selective phone reception.
- Two tuned R. F. stages on all four bands.
- Sensitivity better than 1 microvolt at all points of all bands.
- Ten new Raytheon 6.3 volt tubes—2 6D6 T.R.F. stages, 6D6 S.G. first detector, 41 electron coupled H. F. oscillator, 6D6 high gain, high Q, I. F. stage, 6B7 amplified A.V.C., 76 beat oscillator, 6C6 high gain tetrode second detector, R-meter amplifier, 4Z output and 5Z3 rectifier. Ten tubes with 12 tube functions!
- Polished chromium finish on heavy welded steel chassis fully shielded and temperature isolated for 100% frequency stability.

Compare this receiver feature for feature with any communication receiver on the market selling for as much as \$109.80 and form your own conclusions as to whether or not the Silvertone Professional is a buy of a lifetime at our cut price of \$66.50. We do not have many of these sets left. When they are gone there will be no more; so get your order in the mail today! Order direct from this ad. Shipping weight, 50 pounds.

57 T 3830—Cash ..... \$66.50

Also sold on our Easy Payment Plan, Write for Terms.

SEARS, ROEBUCK AND CO., CHICAGO

## BUILD IT YOURSELF

You can build this Trailer with ordinary tools easily from our step-by-step constructional sheets and large sized blueprints. Finest demand trailer in existence, steps 4. Toilet, Shower, Electric Light, etc. Save 75% of the cost by building it yourself. Send 25c for plans sheet, illustrations and details.



THE PLAN SHOP, 910 Palmolive Bldg. Chicago, Ill.

## LES Correspondence Courses in RADIO and ELECTRICAL ENGINEERING

**ELECTRICAL ENGINEERING** covers complete electrical field. Most modern course. So simplified anyone can grasp quickly. **LOW COST!**  
**RADIO ENGINEERING** Ultra-modern course in radio, public address, photo-electric work. Trains you to be super-service man, real vacuum tube technician. Diploma given. Tuition only \$25, other course. Deferred payment plan.  
**WRITE TODAY** for free copies of school catalogs, student memorandums, etc. **SEND NOW!**  
LINCOLN ENGINEERING SCHOOL  
859-J So. 37th St., Lincoln, Nebr.

Please Say That You Saw It in RADIO-CRAFT

# MILLION Tube Tester

## FEATURES

1. Emission
2. Metal Tubes
3. Shorts
4. Leakage
5. Resistance
6. Electrolytics
7. By-Pass Condensers
8. Neon Alignment

**\$8.45 NET**



25 cycle-\$10.95—220 V-\$9.45

Here's what the Service Men say about the New Million Tube Tester! "Most valuable purchase of test equipment we made during the last year." "It shows up weak tubes better than my expensive—tester."

If your jobber cannot supply you—order direct—20¢ deposit required on C.O.D. orders. Tear out this ad and send it to us NOW for complete information!

**MILLION RADIO AND TELEVISION LABORATORIES**  
363 W. SUPERIOR ST., CHICAGO, ILL.

Manufacturers of  
**VITREOUS TRANSMITTING GRID LEAKS**  
VOLUME CONTROLS • POWER RHEOSTATS

Write for Complete Free Catalog  
**ELECTRAD, Inc.**  
175 Varick Street, New York

EXACT **STANDARD** DUPLICATE  
**TRANSFORMERS**  
STANDARD TRANSFORMER CORPORATION  
850 BLACKHAWK STREET, CHICAGO, ILLINOIS

Get into **RADIO** Earn While Learning at Home!

PHILCO CROSLLEY ZENITH GRUNOW and 46 other mfrs. endorse R-T-1

Television, Photo Electric Cells, Public Address

Many R-T-1 Trained Men make up to \$75 a week and more in full-time spare time alone. More trained men needed. Learn at home by quick, easy, R-T-1

R-T-1 WAY. Endorsed by 60 big concerns. Write for big Opportunity Book FREE. RADIO and TELEVISION INSTITUTE, Inc., 2150 Lawrence Ave., Dept. 22-C, Chicago, Ill.

**"HURRAH—What a Treat"**

Thanks to you S.O.S., I'm off to a ripping start for a BIG SEASON OF PROFIT with your New THEATRE EQUIPMENT catalog is the CATS—and will be able to SELL at your Slashing Savings!

P.S. We'll gladly mail you a FREE copy on request.

**S.O.S. Corp.** Cable "SoSound"  
1600 B'way, N.Y.C.

**SAVE \$\$\$ on RADIOS**

BUY DIRECT 30 day trial

FREE CATALOG

Buy at factory prices. 30 models in choice from AC-DC, All-wave, Farm, Car and Metal Tube models. Send postcard for NEW 1936 Bargain Catalog FREE. Get details of 30 day TRIAL plan and Agent-User proposition. Also ask for our NEW Parts Catalog.

**ZEPHYR RADIO CO.**  
11708 Givernois, Detroit, Mich. DEPT. 228

**SERVICE MEN**

New, handy Pocket Tool Case keeps your tools together in a convenient place. Fits in your hip pocket or fastens on your belt. Saves wear and tear on pockets. Have your tools ready when you need them. High grade genuine leather case, double sewed, snap flap. See it at your jobbers. If he cannot supply you write us. Illustrated circular of Radio Service Aids FREE on request.

**GENERAL CEMENT MFG. CO.**  
(Radio Division) Rockford, Illinois

# MAKING A PRECISION ALIGNING UNIT

(Continued from page 94)

Bands 1, 2, and most of 3, are calibrated in this manner.

When calibrating the higher-frequency bands, the lower calibrated band is used to calibrate the next higher band, as:

Band 2—calibrated band 300-900 kc.; set the calibrated band at 900 kc.; tune receiver to 900 kc. (accurately); do not move dial; change the service oscillator band to No. 2 and tune to resonance with the receiver frequency.

Band 3—calibrated band 900-2,700 kc.; set the calibrated band at 500 kc.; tune receiver to 1,000 kc., the 2nd harmonic of 500 kc.; change the service oscillator band to No. 3 and tune to resonance with the receiver frequency.

As stated before, the low-frequency band is used to calibrate the next higher frequency band and the receiver acts as an indicating device. Thus, between the change-over of bands to get the two notes, the receiver dial is not returned.

## SEQUENCE OF OPERATIONS

Line switch Sw.1—place in On position.  
R.F. oscillator switch Sw.3—turn to On or Off.  
A.F. oscillator switch Sw.5—turn to On or Off.  
Output range switch Sw.4—adjust for desired range.

Output attenuator control R4—adjust for desired range.

Procedure for placing equipment into operation for set alignment:

For an R.F. carrier signal—turn switch Sw.3 to On; Sw.2 to Band Selector; and adjust Frequency Selector C1.

For a modulated R.F. signal—first follow the procedure for securing an R.F. carrier signal, then turn switches Sw.5 and Sw.7 to On Modulation; adjust Percentage Modulation control R10; and set switch Sw.6 to A.F. Selector.

For a modulated R.F. signal (external)—first follow the procedure for securing an R.F. carrier signal, then turn switch Sw.7 to Off Modulation; and adjust A.F. Input Attenuator R13.

For an A.F. signal (external)—turn switch Sw.5 to On; adjust Output Attenuator R10; turn switch Sw.6 to A.F. Selector; and Switch Sw.7 to Off Modulation.

## LIST OF PARTS

- One Hammarlund variable condenser, 350 mmf., C1;
- One Cornell-Dubilier fixed mica condenser, 100 mmf., C2;
- Three Solar tubular condensers, 0.1-mf., 200 V., C3, C4, C5;
- One Cornell-Dubilier fixed mica condenser, .001-mf., C12;
- Two Cornell-Dubilier fixed mica condensers, 250 mmf., C13, C14;
- Three Aerovox or Sprague electrolytic condensers, 8 mf., 150 V., C15, C16, C17;
- One Aerovox or Sprague electrolytic condenser, 15 mf., 150 V., C17;
- One-Solar tubular paper condenser, 0.1-mf., C19;
- Nine Cornell-Dubilier condensers, C20, C21, C22, C23, C24, C25, C26, C27, C28 (sizes optional, depending upon range desired);
- Three Solar tubular condensers, 0.05-mf., 400 V., C29, C30, C31;
- One Aerovox condenser, 0.5-mf., 200 V., C32;
- One Aerovox condenser, 0.5-mf., 600 V., C34;
- Two Hammarlund R.F. chokes, 60-85, mhy., L1, L3;
- One Hammarlund shielded, pie-wound R.F. choke, 85 mhy., L2;
- \*\*One kit of oscillator coils L4-100 to 300 kc., L5-300 to 900 kc., L6-900 to 2,700 kc., L7-2,500 to 7,500 kc., L8-7,500 to 22,500 kc., L9-22,000 to 60,000 kc.;
- One R.F. choke, 20 microhenries (25 turns of No. 22 enameled wire, single-layer wound on a bakelite rod 1/2-in. in dia.) L10;
- One Aalloy center-tapped audio oscillator coil (standard push-pull input transformer secondary), L11;
- One Aalloy midget filter choke, 100 ohms, L12;
- One Continental Carbon resistor, 0.25-meg., R1;
- One Electrad resistor, 150 ohms, R2;
- One Continental Carbon resistor, 50,000 ohms, R3;
- One Electrad dual wire-wound variable resistor, 100 ohms, R4;
- Two Electrad resistors, 5,000 ohms, 1 W., R5, R6;
- One Electrad wire-wound resistor, 30 ohms, R7;
- One Electrad resistor, 400 ohms, R8;

- Two Continental Carbon resistors, 15,000 ohms, R9, R11;
- One Centralab potentiometer, 5,000 ohms, R10;
- One Continental Carbon resistor, 1 meg., R12;
- One Centralab potentiometer, 0.5-meg. (coupled with R10), R13;
- One Continental Carbon resistor, 2 megs., R14;
- One Continental Carbon resistor, 0.5-meg., R15;
- One Centralab potentiometer, 50,000 ohms, R16;
- One Centralab potentiometer, 5,000 ohms, R17;
- One Shalcross precision resistor, 50,000 ohms, R18;
- One Continental Carbon resistor, 10,000 ohms, R19;
- Five S.P.S.T. toggle switches, Sw.1, Sw.3, Sw.4, Sw.5, Sw.11;
- One 4.P.6.T. rotary switch, Sw.2;
- One 2.P.6.T. rotary switch, Sw.6;
- One D.P.D.T. toggle switch, Sw.7;
- One S.P.S.T. switch mechanically coupled to R17, Sw.8;

One pushbutton switch (the writer built this up, from multiple-contact phone jacks), combined of a D.P.D.T., S.P.S.T. and a break contact, Sw.9;

One S.P.D.T. toggle switch, Sw.10;

Two Eby 5-prong sockets, for V2, V3;

One Eby 6-prong socket, for V4;

One Eby 8-prong socket, for V1;

\*\*Eight insulated tip-jacks, J1 to J8;

\*\*Five pairs insulated phone-tips;

\*\*One 5-prong male plug;

\*\*One 6-prong male plug;

\*\*One 7-prong male plug;

\*\*One 8-prong male plug;

Ten alligator test clips;

One line cord and plug;

Eighteen ft. of shielded low-capacity wire;

\*\*One kit of test leads with attachments;

\*\*One steel cabinet (8 x 10 x 12 ins. deep), complete with metal panel, (8 x 10 x 1/16-in. thick), chassis, and hardware;

One General Transformer Co. special power transformer (for the home constructor, directions for rewinding a standard power transformer were given in the July, 1935, issue of Radio-Craft, in the article, "Service Man's Companion"), T.

\*Note No. 1: When simultaneous operation of the two units is desired (the vacuum-tube voltmeter and the signal generator), it is necessary to couple the ground terminal of the oscillator through a 0.1-mf. condenser, at X, as shown in the diagram (Fig. 2, Part I) to secure operation of the two units without interference, or the unbalance of one of the units (the V.-T.V.M.).

\*\*Name of manufacturer upon request.

†Only the plate connection of each plug is used, as shown in Fig. 1D, Part I.

## IMPEDANCE MATCHING SIMPLIFIED

IMPEDANCE matching transformers must have a turns ratio equal to the square root of the ratio of the 2 impedances. In the table below, "Z ratio" is the number obtained by dividing the larger impedance by the smaller. The "T ratio" is the required turns ratio for a good match. Example: the load for a 47 pentode is 7,000 ohms; voice coil of speaker is 6 ohms, ratio, 1,167. The number nearest to this is 1,156, indicating a 34 to 1 transformer. This will be step-down as the larger number of turns always connects to the larger impedance. For impedance ratios below 121, square numbers below 11; choose the square that is nearest the impedance ratio; original number is then transformer ratio. For smaller impedance ratios, fractional T ratios may be necessary. Thus a 3 1/2 to 1 transformer matches a Z ratio of 12, also 13.

Z Ratio	T Ratio	Z Ratio	T Ratio	Z Ratio	T Ratio	Z Ratio	T Ratio
121	11	361	19	729	27	1225	35
144	12	400	20	784	28	1296	36
169	13	441	21	841	29	1369	37
196	14	484	22	900	30	1444	38
225	15	529	23	961	31	1521	39
256	16	576	24	1024	32	1600	40
289	17	625	25	1089	33	1681	41
324	18	676	26	1156	34	1764	42

WALTER E. KNEVER

Please Say That You Saw It in RADIO-CRAFT

READERS' DEPARTMENT

(Continued from page 95)

Even with 110 V. D.C. supply, better results may be had with these universal sets if the filter and rectifier are temporarily shorted out.

M. E. CAGLEY

THE CIRCUIT IS CORRECT

Fort H. G. Wright, N. Y.:

In your April, 1936 issue, page 609, there is an article entitled "Direct-Impedance Amplification," written by Mr. L. Mitchell Barcus. This article describes a new type of high-fidelity receiver and gives a circuit diagram of same. I am desirous of building this receiver, but in going over the diagram I find what appears to be an error which would prevent the receiver from working if it was wired as shown.

In the cathode circuit of V5, the 2nd A.F. amplifier, I find that the low-voltage end of the plate load impedance of the preceding tube, V4, is grounded through a condenser, and connected directly to the cathode of V5. This point is then connected directly to the center-tap of the heater winding of V5 on the power transformer. There is no connection to the ground anywhere in the cathode circuit, yet the plate of V5 is connected to +350 V. D.C. I cannot see where the A.F. section of V4 has any plate voltage or low plate current is to flow in the plate circuit of V5. The above-mentioned potential of 350 V. is grounded at the negative side. Apparently some resistor from the ground to the cathode has been omitted.

If the diagram is correct please advise me how it works; and if not, please tell me what changes to make.

RALPH C. YINGLING

The following answer was sent to Mr. Yingling by Mr. Barcus, to whom we forwarded the original request:

"In your letter of April 13th, you ask a question that is commonly brought up by constructors of amplifiers of the 'direct-impedance' type. This has to do with the circumstances surrounding the connections to the plate of the 1st A.F. stage.

"In all of the direct-impedance amplifiers which I have designed, the cathode of the 2nd A.F. stage is a floating circuit. Close inspection will reveal that the 1st and 2nd A.F. stages are in series, and that the plate supply for the first is derived from the cathode of the second. Should the cathode be grounded, either directly or through a resistance of low value, the circuit will become inoperative. The large bypass condenser between the cathode and ground is for the purpose of completing the function of the 1st A.F. choke in smoothing out audio fluctuations and supplying a steady current to the cathode of the tube.

"The voltage at this point is not a steady value, but varies over a considerable range depending upon the input signal and other factors. A complete discussion of this point would be rather involved and is not necessary here. However, this complete freedom of the tube functions is one of the reasons for the amazingly clear tone possible from the amplifier.

"The use of the separate filament supply to the 56, V5, is necessary because the cathode is normally 100 V. or so more positive than the heater, and this difference in potential would exceed the permissible rating of 40 V. between the 2, were the common heater supply used.

"While it is recommended that you build one of the larger models of these receivers, such as the one to appear in Part II, you will find that this receiver will provide astounding performance."

L. MITCHELL BARCUS

OOPS!

Cambridge, Mass.:

I wish to call your attention to what might well prove a very troublesome error in one of your prize-winning letters giving a radio "kink," in the April issue of Radio-Craft.

Mr. P. Mortz, winner of the 3rd prize of \$5.00 (which I think Mr. Mortz should give back), in an article entitled "Filament Supply," the 3rd article on p. 601, makes the following statement: "The formula for finding the size of the condenser is: E (Volts) = 1,200 x I (amperes) x

C (capacity). For example, in the case illustrated,  $108 = 1,200 \times 0.06 \times C$ , which works out to  $C = 1.5 \text{ mf.}$ "

This is an error, and it is only this particular choice of values which caused Mr. Mortz's formula to give the correct result (which it happens to do here, at least when carried out to only 2 significant figures). For what it may be worth, I will give a correct solution to this problem, with a final simplification: The voltage drop

across a condenser is given by: 
$$e = \frac{1}{C} \int i dt$$
 in which

e is the instantaneous voltage; i is the instantaneous current, t is the time in seconds, and C the capacity of the condenser in farads. Solution of this differential equation, using a cisoidal current (which I shall not go into here)

gives for the steady state solution: 
$$E = \frac{I}{\omega C}$$

in which E and I are the voltage and current respectively, in complex form,  $\omega$  is the angular velocity of the alternating current vector and equal to:  $2 \pi \times$  the frequency in cycles per second. This gives the following formula, discarding the complex notation as well as the j (equal to the square root of -1), since these quantities concern the relative phase of current and voltage, and our concern is with amplitude

only: 
$$E = \frac{I}{2 \pi \times f \times C}$$

In the foregoing expression, f is the frequency in cycles per sec., and  $\pi$  is equal to 3.1416. The capacity C is still given in farads or in  $\text{mf.} \times 10^{-6}$ . Now in general use, the frequency is 60 cycles per sec. Substituting this and the values given in the preceding paragraph:

$$E = \frac{I}{2 \times 3.1416 \times 60 \times 10^{-6} C}$$

C is now in  $\text{mf.}$ , E is in volts, and I is in amperes. Simplification now gives:

$$E = \frac{2655 I}{C}$$

$$C = 2655 \times \frac{I}{E}$$

in which C is the capacity in  $\text{mf.}$ , I the current to be passed in amperes, and E is the voltage drop desired, in volts.

Incidentally, Mr. Mortz's values, substituted in this equation, give a desired capacity of between 1.4 and 1.5  $\text{mf.}$ , for which his value of 1.5 seems a fairly practical solution, as certainly the remainder of the voltage drop may be obtained by means of a rheostat.

FRED A. DARWIN

ORSMA MEMBERS' FORUM

(Continued from page 100)

if they would work toward the enactment of a law requiring Service Men to pass a rigid examination proving their ability, and a license fee of perhaps \$15.00 a year. The enactment of such a law I believe would clear up practically all the difficulties now in the radio service profession.

I might add that I have been in the radio service business both for myself and in charge of service departments not belonging to me for the past 10 years. I would like to see this letter published and I would like to have the editors' views, and the views of any Service Men, on this subject.

F. D. BUCHANAN,  
Owatonna, Minn.

While we agree completely with the contention of Mr. Buchanan that a reform is needed in this profession, we are afraid that the government license fee idea which we advocated a long time ago will not meet with much approval. However, there is the idea and we will welcome any and all comments upon it.

Please Say That You Saw It in RADIO-CRAFT



E. H. RIETZKE

President, CREI

CREI TRAINING

Gives Every Man  
The Opportunity  
to Get Ahead . .

Ambition alone, will not bring a better job and salary . . . you MUST also have the necessary TECHNICAL TRAINING. A recent survey among our graduates proves that CREI training is beneficial. Statistics show that the majority of our graduates have greatly improved their positions and increased their salaries.

PRACTICAL RADIO ENGINEERING

Available in home-study form, or at our one-year Residence School in Washington. New term starts Sept. 21st. Start home study at any time. This course covers every phase of Radio Engineering; well-balanced in mathematics, theory, practice and practical engineering problems.

SERVICE AND PUBLIC ADDRESS ENGINEERING

A newly developed course for EXPERIENCED service men who feel the need for Technical Training. Practical right from the beginning and priced within reach of all. Teaches theory PLUS the principles of design. Write for details about this new, popular service course.

MAIL THIS COUPON TODAY!

Please send me complete details and illustrated booklet regarding your Courses in Practical Radio Engineering and Service and Public Address Engineering.

Name .....

Address .....

City .....

CAPITOL RADIO ENGINEERING INSTITUTE

WASHINGTON D. C.  
14th & Park Road

Dept. RC-8

NEW YORK CITY  
29 Broadway

ELECTROLYTIC MIDGETS



Popular PBS Series card-board-case electrolytics provide reliable capacity at lowest cost. • Single, dual, triple section units. 200 and 450 v. working. Popular capacities. • Ideal general utility units because of compactness. • Write for catalog.



CORPORATION  
77 Washington St. Brooklyn, N. Y.

# Weather Forecaster

AND  
HUMIDITY  
TESTER

**"HYGROSCOPE"**

The Ace of Weather Forecasters

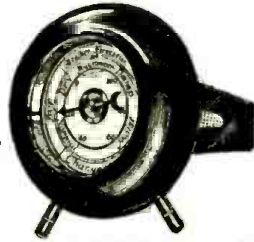

When placed in a well-ventilated room or in the fresh air, the HYGROSCOPE foretells coming weather conditions from eight to twenty-four hours in advance. It also accurately records outdoor humidity, and when placed inside it gives the humidity within the house or room.

The HYGROSCOPE is automatic self-adjustable, simple American-precision made. It cannot get out of order at any time. The dial measures 2 3/4", is enclosed in a 6" round hardwood case, with either walnut or mahogany finish. It is attractive for desk or living room.

### OUTSIDE DIAL FORECASTS WEATHER

Fair—rain—or changeable is indicated on the outer dial when the HYGROSCOPE is placed in a well-ventilated room or out-of-doors. If indoors, place the instrument near an open window.

### INNER DIAL SHOWS HUMIDITY CONTENT

The HYGROSCOPE also acts as a hygrometer. Numbers on the inner dial indicate the degree of humidity present in the air and in artificially heated rooms.

SEND YOUR ORDER NOW! Get your HYGROSCOPE today. Your remittance in form of check or money order accepted. If you send cash or unused U. S. Postage Stamps, be sure to register your letter. Also specify if you prefer the HYGROSCOPE in Walnut or Mahogany.

**\$200**  
Postpaid

**GREN PARK COMPANY**  
Dept. RC-836  
99 Hudson St. - New York, N. Y.

# THE LATEST RADIO EQUIPMENT

(Continued from page 96)

## A 32 V. POWER PLANT (1080)

ONE of the big features of this unit is the collector ring assembly which allows the generating unit to revolve freely without having any wires to tangle. The tilting principle is used to slow the generator down as the wind velocity increases. The charging begins at a wind speed of 10 m.p.h. with a maximum capacity of 15 A. The plant may be had with or without a 5-ft. steel tower and may be supplied with a 6-V., 35-A. generator.

## AUTO P.A. SYSTEM (1081)

A FALSE bottom on this unit enables the operator to set the case so that the turntable is always level. Operation is entirely from a 6-V. storage battery. The power output is 20 W. The turntable is of the 2-speed type and will play up to 16-in. records. The amplifier is designed for use with a crystal microphone, and has controls for mixing the outputs of the microphone pickup.

## ULTRA-SHORT WAVE POWER SUPPLY (1082)

MOBILE ultra-high frequency operation may be facilitated by the use of this power supply. It consists of 2 separate dynamotors mounted on one base which houses a comprehensive filter system. One unit supplies 250 V. at 50 ma., while the other gives 350 V. at 100 ma. Note that the unit will not cause interference in any ultra-high frequency receiver. Cooling vents are provided in the cases and the bearings are of the quiet-running ball-bearing type which requires no oiling.

## STREAMLINE AUTO ANTENNA (1083)

(Norwest Radio Labs.)

HIGH efficiency is obtained by use of this antenna. It is impervious to mud, ice, or water, and its position on top of the car makes it more efficient than other types of car antennas in pick-up. It is intended particularly for use on cars having turret tops, but works equally well on the more usual fabric top. No holes need be drilled, since the antenna is held in place by means of rubber suction cups.

## NEW AUTO RECEIVER AND CONTROL (1084)

MANY valuable features are incorporated in this receiver. It has an antenna filter circuit, a sensitivity control, class B output, and the latest octal base tubes. No speaker is included in the case since the set is intended to be used with 1 or 2 outside speakers, which connect by means of plugs on the side of the case. (Further information may be had from Data Sheet 172.)

Since there has been some publicity on the possibility of auto radio receivers adding to the dangers of driving, a special safety dial has been developed to go with this receiver. It is large and easily read and very clear from any angle. The figures and the pointer are both indirectly illuminated and they light up only when the receiver is actually being tuned. When the operator removes his hand from the tuning knob, the light goes out, so that there is no cause for distraction of the driver's attention.

(Continued on page 119)

## AN ADVANCED COMMUNICATION RECEIVER (1090)

(Continued from page 97)

them: Thus transfer of energy from the antenna to the grid is limited to pure electromagnetic coupling. The 3rd and 4th coils in each band are special R.F. transformers, and the 5th is the high-frequency or heterodyne oscillator coil. Each coil has a trimming condenser mounted on its isolantite base for circuit alignment at the high-frequency end of the band. At the low-frequency end, alignment is accomplished by adjusting the inductance by means of a copper disc located on top of each coil form. The selec-

tivity of the I.F. amplifier is continuously variable from the front panel. The control simultaneously varies the coupling between the primaries and secondaries of the 3 I.F. transformers. Since both the primary and secondary of each transformer are tuned, this variation of coupling changes the response characteristic from the single sharp peak in the minimum coupling position to a wide, double-humped curve in the position of maximum coupling.

The circuit with values is shown below.

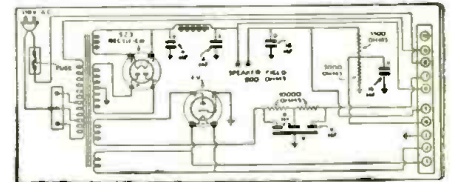

The circuit of the separate power supply for the receiver below. Note bias rectifier. (1090)

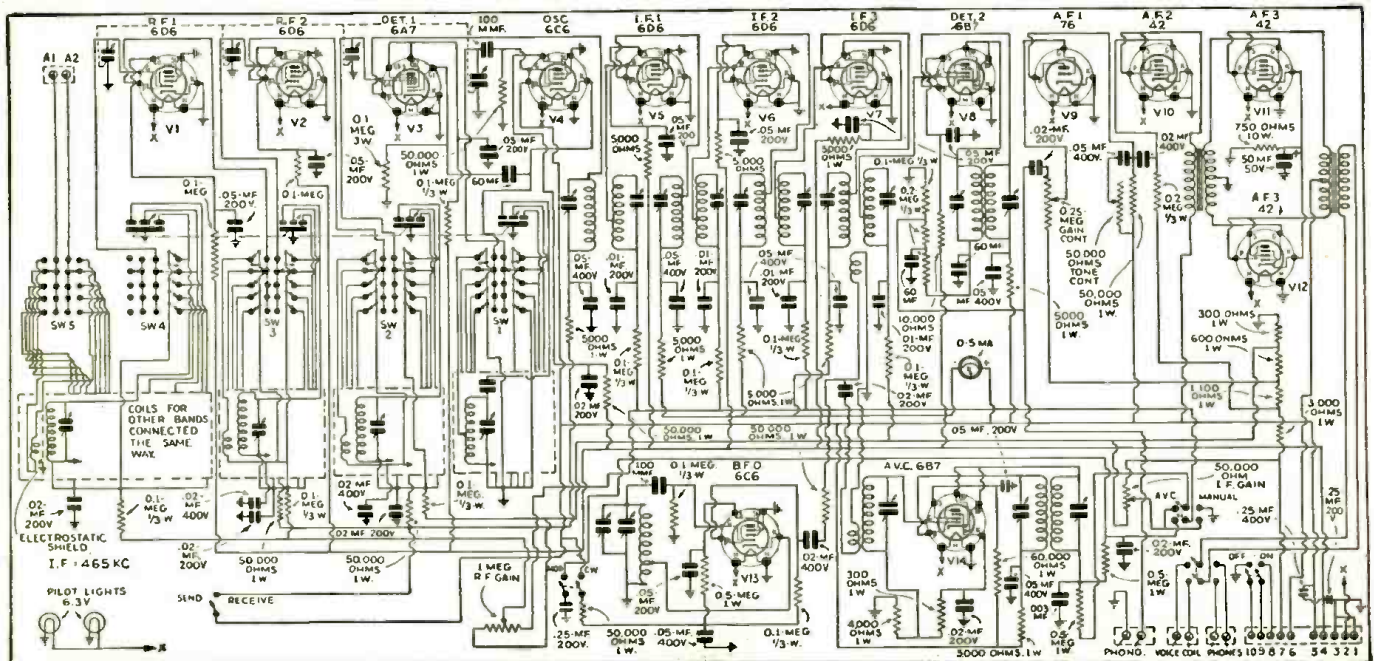

This circuit of the new Hammarlund "Super-Pro" receiver is of especial interest since it is the first time all component values have been published. (1090)

Please Say That You Saw It in RADIO-CRAFT



**ALL-WAVE ANTENNA (1085)**  
(RCA Mfg. Co., Inc.)

**A** COVERAGE up to 23,000 kc., with optional range to 70,000 kc. is assured with this antenna. It is of the multiple doublet type and incorporates an improved transmission line to the receiver. The space required is only 38 ft. long with a vertical clearance of 12 ft. The antenna system comes from the factory completely assembled and soldered, so that installation takes but a short time. The use of 7-strand, No. 22 wire assures sufficient strength to withstand the hardest weather.

**"A" BATTERY ELIMINATOR (1086)**

**D**EMONSTRATING and testing auto receivers is facilitated by the use of this apparatus. It delivers pure D.C. of the proper voltage for any auto receiver and is equipped with a dry-disc rectifier to assure quiet economical operation. The case is of heavy metal and carries on one side, an on-off switch, pilot lamp, and the output terminals. A 10-A. fuse is contained in the case. The latter measures 7½ x 7½ x 5 ins. high; the total weight is 20 lbs.

**CAR-RADIO SPEAKER-ADAPTER CORD AND PLUG (1087)**  
(Wright-De Coster, Inc.)

**D**EMONSTRATION of extra speakers is easy with one of these plugs. It fits directly into the type 41 or 42 tube socket. The cord then is run to the outside speaker.

**INTRA-DEPARTMENT COMMUNICATION SYSTEM (1088)**  
(Bell Sound Systems, Inc.)

**C**OMMUNICATION between offices or rooms of a home is made simple and quick by the use of this equipment. The only controls are a pilot light, volume control with power switch, and a send-receive switch. The basic unit is the amplifier which measures 5¼ x 8 x 4¼ ins. deep and contains a special 3½ in. crystal unit which serves as both speaker and microphone.

For greater coverage or higher volume, a separate 6-in. alloy core speaker unit is furnished. The amplifier utilizes 3 tubes, 1-25Z6, 1-25A6, and 1-6F5, in an A.C.-D.C. circuit.

**COMBINATION TESTER (1093)**  
(Precision Apparatus Co.)

**H**ERE is a tester for the Service Man which combines a set analyzer and a comprehensive tube tester in on compact case. The overall size is 20½ x 12½ x 6 ins., and the weight 20 lbs. The analyzer uses the rotary selector switch system and has 2 meters, one for A.C. and one for D.C. readings. There are 5 D.C. voltage ranges from 0-5 to 0-1,000 V., and 5 A.C. ranges from 0-4 to 0-800 V. Also included are 3 each ma. and ohms ranges and a direct reading capacity scale. The tube tester has an English-reading scale on its one meter and all multiple section tubes are tested so that each section may be rated separately. Various short and leakage tests are included. Tubes are all tested under correct load. The Service Man will find in this unit a complete servicing laboratory. Combined with a reliable all-wave oscillator, it will supply all the needs for both shop and outside jobs.

**NEW SPEAKER DESIGN (1094)**  
(Cinaudagraph Corp.)

**R**EVOLUTIONARY features are included in the design of this speaker. The voice coil is wound on a quartz form, chosen because it is extremely dense and non-elastic. This coil fits into a special recess in the cone, there being no orifice as usually used. Especial material is used for the cone, which is formed to an exponential curve. The usual center spider suspension is dispensed with and in its place, an interlaced centering net is employed, this net allowing perfect freedom only in an axial direction. The magnet is of a new substance called "Nipermag," which assures an extremely intense magnetic flux without the need for electrical field excitation. A compact "infinite baffle" has been developed to enable the speaker to be used to best advantage. This baffle has an equivalent area of over 10 sq. ft., making it ideal for any P.A. requirements.

This remarkable speaker represents the results of intensive research work in a field that has been neglected by most radio engineers.



set needs carefully-made tubes to reproduce tone accurately, and in volume. Tung-Sol tubes qualify. They are mechanically right.. the kind upon which a service organization can stake its reputation.

**TUNG-SOL**  
Tone-flow radio Tubes  
Tung-Sol Lamp Works, Inc.  
Radio Tube Division  
NEWARK, N. J.



**ADVANCED . . . . .**  
**AMATEUR—PROFESSIONAL**  
**RECEIVER**

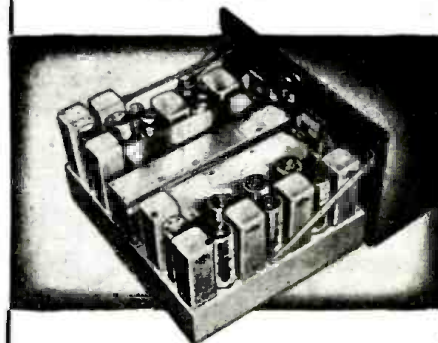

**Hammarlund "Super Pro"**

The "Super Pro," the newest Hammarlund receiver is truly a model unit. More striking features than have ever been incorporated in any receiver will more than provide that exacting efficiency you want! The only receiver with exclusive Hammarlund silver-plated, five-band cam switch, positively fool-proof and noiseless. Only receiver with 12-gang band spread condenser. Hundreds of other unusual features in the "Super Pro." Mail coupon below for full story!

Send for your copy today!

**Hammarlund Manufacturing Co., Inc.**  
424-438 W. 33rd St., New York RC-8

- Check here for complete data on the new Hammarlund "Super Pro."
- Check here for the 1936 Hammarlund catalog.

Name .....

Address .....



Turret-top antenna. (1083)



Safety set control head. (1084)

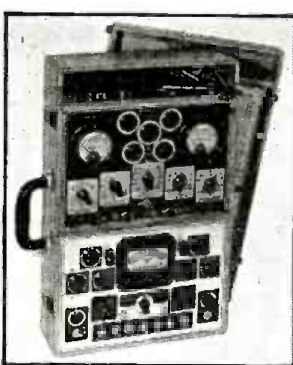

Combined tube and set tester. This unit in its neat carrying case includes practically all the "tools" a Service Man needs. (1093)



Spider-web all-wave antenna. (1085)

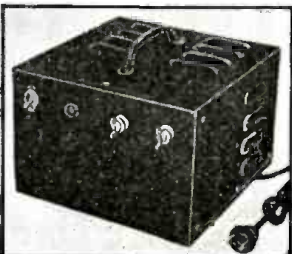

"A" battery eliminator. (1084)



Communication system. (1088)

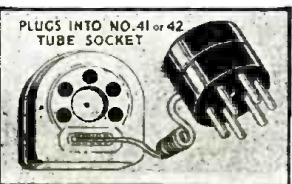

Car radio speaker adapter. (1087)



New type alloy-core speaker. (1094)

Please Say That You Saw It in RADIO-CRAFT

# Westinghouse Power Generator

Manufactured for U. S. Signal Corps

200 Watt. 110 V. AC

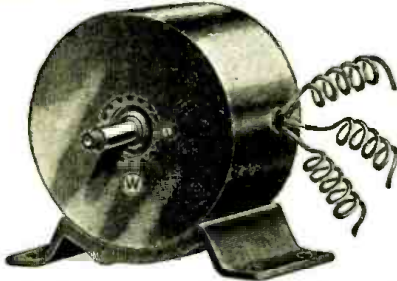

## A. C. ELECTRICAL POWER

from a Windmill, from available Waterpower, from your Automobile, from your Motorcycle, from your Bicycle, Foot-pedals or Handcrank; operates A.C. Radio Sets in D.C. districts, also A.C. Radio sets from 32 V. D.C. farm light systems; use two generators in series to get 200 V. A.C. Used as an A.C. Dynamo, lights ten 20 Watt 110 Volt lamps; Short Wave Transmitter supplying 110 Volts A.C. for operating "Ham" Sets; Motor Generator; Public Address Systems; Camp Lights; etc., etc.

### There Are Over 25 Applications

#### Specifications:

HOUSING—Aluminum (Diameter 6 3/4 in. Length—5 1/4 in.). SHAFT—2 3/16 in. (driving end). Diameter—9/16 in. (the end is threaded for a distance of 1/4 in.). BASE—Cast Iron (Length—7 3/4 in. Height 1 9/16 in. Width 4 1/4 in.). OUTPUT—200 Watt 110 volts AC (speed 4500 R.P.M.). STATORS—Two pairs (two North and two South). ROTOR—12 tooth inductor. Built-in commutator. Motor turns in ballbearings.

1/4 to 1/2 H.P. needed to run generator.

BLUE-PRINT 22 x 28 in. and Four-Page 8 1/2 x 12 in. Applications and INSTRUCTION SHEETS FREE with Generator.

Generator, as described, including four replacement carbon brushes. Blue-Print and Instructions ..... **\$7.90**

Send \$2.00 deposit balance C.O.D. Shipping weight 18 lbs.

(Replacement carbon brushes bought separate \$1.50 per set of four. Set of Instructions bought separate \$1.00.)

# SPRAYER OUTFIT

ELECTRICAL—PORTABLE

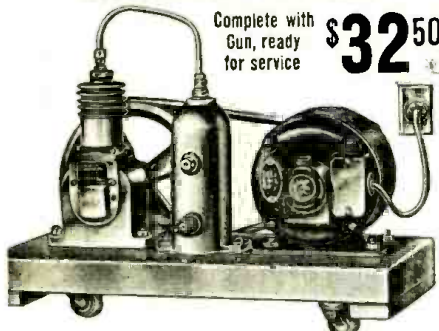

Complete with Gun, ready for service **\$32.50**

This is the ideal outfit for all around spraying work wherever Current is available. Sprays everything: Lacquers, Oil, Cold Water Paints, Enamels, Varnish, Insecticides, Disinfectants, Shoe Dyes, etc. The Unit is compact, completely self-contained.

Ideal for spraying Furniture, Radiators, Screens, Machinery, and other maintenance paintings in Homes, Schools, Clubs, Hospitals, Stores, Factories, and Office Buildings.

The Gun furnished with this Unit is of Pressure Cup type, requires but 2 cu. ft. of Air per minute. Has Bleeder type construction which assures uniform pressure at all times without clogging the Air Passage which is easily cleaned. Furnished with 3 Nozzles which produce Fan, Round, and Light angle Spray respectively.

Complete Unit consists of Air-cooled Compressor with machined Fan-cooling Pulley, V-Belt Drive; Pressure type Gun with 1 quart Aluminum Paint Cup; 3 Tips; 1/2 H.P. Heavy Duty Motor, 110/120 volt, 60 cycle, AC; 15 ft. rubber covered 2 Ply Air Hose; 8 ft. Cord & Plug; Filter Tank; Entire Unit mounted on Base with Ball Bearing Casters.

A low priced Power Sprayer: the kind of Machine that usually sells for \$50.00 to \$60.00.

Price of complete outfit, shipping weight, 60 lbs. **\$32.50**  
Price of outfit complete, less Motor, shipping weight—35 lbs. **\$25.50**

Strict Money-Back Guarantee

All Shipments will be forwarded by Express Collect if not sufficient postage included with your order.

# WELLWORTH TRADING CO.

560 W. Washington Blvd., Dept. RC-836, Chicago, Ill.

# NEW DEVELOPMENTS IN TELEVISION

(Continued from page 75)

## EMPIRE STATE BUILDING TRANSMITTER

It is estimated that the power of W2XF will be sufficient to develop a field strength of 5 microvolts, at 1 meter height; this is the rated input sensitivity required for good image reproduction in residential areas.

Just how much shadow effect exists, due to the tall steel buildings in the metropolitan area, nobody knows—that's one of the reasons for these preliminary tests.

The purpose of operating this experimental transmitter, in conjunction with a number of special, experimental receivers assigned only to engineers of the company for checking various performance characteristics, is to take television out of the laboratory in an effort to determine within the next 18 months or so, if possible, just what obstacles are yet to be overcome, before commercial television can be instituted, in the face of the following problems:

1. Short range.
2. The difficulty of securing intercommunication between network stations.
3. Suitable program selection, arrangement and production.
4. Commercial profit.
5. Static interference (particularly from automobiles).

Any transmissions that take place, for some time to come, can only be on an experimental basis, since the Federal Communications Commission has not as yet granted a single license to any company for commercial visual (television) broadcasting.

## THE RCA EXPERIMENTAL-TYPE TELEVISION RECEIVER

It is probable that almost identically the same experimental receiver design will be employed in receiving the signal from this station, as was used during the recent press demonstration in Camden. The set in question has been described in the daily press, but for completeness its general details will be repeated insofar as the writer can recall them.

The set is designed for reception of 343-line images, interlaced, and 30 frames per minute. When transmitting film programs, a special "intermittent" in the transmitter speeds the action and sound, slightly, as the normal 24-frame movie film is sped through the mechanism at 30-frame speed. This makes it very convenient in most instances to secure the framing frequency from the 60-cycle electric light power supply that is common both to the transmitter and to all the receivers. (Thus, where the receiver is operated from a power supply not connected into the same power system as the transmitter, an additional filter system will be required in the receiver in order to select a framing frequency from the received signal.)

The receiver proper utilizes a total of 32 tubes, plus a 9-in. cathode-ray tube, for combined image and sound reception, at an estimated cost (per experimental set) of \$500 to \$1,000. The total current consumption of this experimental receiver is about 350 W. The cathode-ray tube mounts vertically in the console cabinet, the image being viewed on a mirror set into the lid of the receiver and tilted "open" 45 deg. This mirror is of chromium-plated steel, which eliminates the double-reflection effect of silvered glass. The cathode-ray tube operates at 6,000 V., but the current drain being only a fraction of a milliampere any shock a Service Man might experience under exceptional conditions would not be excessive. A shatter-proof glass cover-plate over the tube protects it. Although a special cathode-ray tube is used in this set a very similar type is available on the open market at a cost of about \$100. The conservative life rating of this tube is about 500 to 1,000 operating hours. Audio and visual signals are sent over the one television channel, with a blank safety zone between the two as shown in the accompanying illustration.

It is very easy to tune this receiver, not even

a tuning meter or other visual indicator being required; tuning-in the sound for best reception automatically and exactly tunes in the image frequency. A broad-band R.F. and first-detector circuit amplifies both image and sound; but individual I.F. amplifiers are provided for the visual and image signals. The front of the cabinet is provided with 1 tuning knob, 3 image-receiver controls, and 3 sound-receiver controls. The receiver tunes over a frequency range of 40 to 84 megacycles (approx. 7.5 to 3.5 meters), thus tuning-in 4 "visual broadcasting" (television) bands. On the top-inside of the opened-up cabinet is ranged, along the front, a row of 7 controls for adjusting the cathode-ray tube circuits for best operation. Once adjusted, there is little additional adjusting; it is understood that a commercial model, for private use, would have but few of these adjustments.

The actual television programs we may expect to sometime see and hear over sets of this general type subdivide as follows:

- 1—Studio; 2—Outside; and, 3—Film.

Ralph K. Beal, Research Supervisor, RCA, made some interesting remarks in connection with such programs, last month. He was speaking at The American Museum of Natural History, in a symposium on television held under the auspices of The American Institute. The following data, taken from the writer's notes of this New York meeting are supplemented by notes made at the earlier talk and demonstration at the RCA factory in Camden.

## TELEVISION STUDIO WORK IN FUTURE

Television in many respects is closely allied to the moving picture industry, from which latter, more experienced field much may be learned. However, the very contrasts between television and movie technique become more evident when comparisons are drawn.

For instance, it is usual to put in perhaps 8 hours of preparatory work, getting everything "all set" for a "shot" of only about 15 minutes duration, using "stand-ins" so that lighting, etc., may be properly adjusted; only then do the actual performers go onto the "set," and then for only about 3 minutes at a time. In television, substantially the same intense lighting arrangement is used as on the movie "lot," but the television performers will be expected to stay under the lights until the program is fully completed—which may be a matter of 10 or 15 minutes, at least!

Such extreme demands are going to require, among other things, special cooling systems that will be noiseless, yet function to keep performers under the Klieg lights (or their equivalents) as cool as possible; it would be fatal to the esthetic effect of many programs, should the performers become beaded with perspiration!

Perhaps the use of infra-red or ultra-violet light will solve the lighting problem, since the television camera can be made to respond to either "illuminant." (The use of infra-red "light" in wired television, in Germany, is described on the Pictorial Page of this issue.)

Make-up, too, is an almost unexplored field of television. True, the art of make-up is a very old one in Hollywood, but here again television and movieland are but distant cousins.

Let's look at it this way. The movie camera records light variations on a chemically-sensitive surface—the film; the television camera is concerned with changes on an electrically-sensitive surface—the photoelectric cell (or its

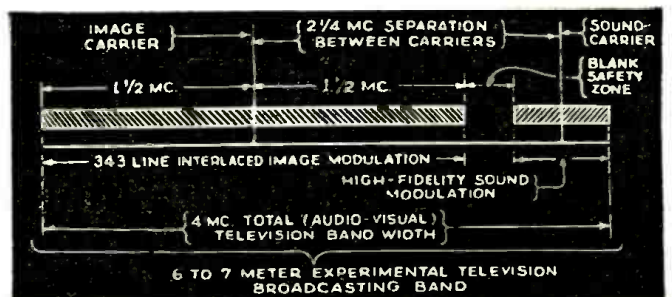

General relation of frequencies in RCA experimental television transmissions. The safety zone is limited by the image-sound modulation.

Please Say That You Saw It in RADIO-CRAFT

equivalent). Now, the film does not respond to light variations with respect to the various colors of the spectrum, to quite the same degree as the light-sensitive cell. Just as it is possible (in the case of the film) to obtain a film that will be exceptionally responsive at the red end of the spectrum, or at the blue end, as desired, so too it is possible to obtain light-sensitive cells that favor either end of the spectrum. Just what range, and ratio of color and light intensity response will be found best suited is a matter of conjecture. (The make-up procedure under infra-red light would be entirely different from that to be used in ultra-violet light.) Whatever is eventually decided upon (and the choice may include several types, to meet individual conditions), you may be sure that the make-up man is going to have his hands full, learning just how, and how much to lay on the various colors so that the reproduced image will have the proper halftone shadings between the extremes of light and dark.

Thus it is plain to see that even the experimental angle of television is rapidly opening new opportunities for employment. The television development laboratories are fast approaching a point where the services of others besides research engineers will soon be in demand to aid in the presentation of visual programs.

Harry R. Lubcke, Director of Television of the Don Lee Broadcasting System, in "Tele-

vision as a Profession," in the January, 1936, issue of *The International Photographer*, states further:

"The present positions in the radio field throughout the country embrace the posts of director of television activities, television engineer, television operator, and television technician. . . . This group of positions will gradually expand to include the television continuity writers, program directors, producers, advertising salesmen and executives."

In concluding this article the writer points out that the scene depicted on the cover of this issue of *Radio-Craft* is representative of an actual "action" television pick-up staged for RCA by the Camden, N. J. fire department, during the special demonstration previously mentioned. The Zworykin Iconoscope camera, of the type shown at lower-left, pg. 74, was used to televise the scene from a window on the second floor of one of the company buildings. (Except for the fire engines, some smoke, and an RCA ad. on the billboard—with, of course, 343-line definition—, this outdoor scene was identical to the 180-line image reproduced in the article, "A Modern Picture of Television," by Wilhelm Schrage, in the May, 1935, issue of *Radio-Craft*, pg. 673! Incidentally, the television receiver shown immediately above this photo, except that it has only 5 control knobs and these placed horizontally is almost identical in exterior appearance to the one used in the later demonstration.)

## BOOK REVIEWS

**TELEVISION**, by M. G. Scroggie. Published by David McKay, Co.; 1935. Size, 5 x 7 1/2 ins., 68 pages. Price, \$1.50.

The author has written this book to appeal to 2 distinct classes—the non-technical public, and the amateur and experimenter who wishes to learn the latest in the art of television. He has succeeded admirably, as the text is not too technical nor is it so simple as to be of no use to the experimenter.

**A FUGE IN CYCLES AND BELS**, by John Mills. Published by D. Van Nostrand Co., Inc.; 1935. Size, 5 1/2 x 8 1/2 ins., 264 pages. Price, \$3.00.

What is electricity doing for music? The answer to this simple question may be found written in a most understandable style, in this new book. The author believes that the electrical developments of the last decade or so had a great effect on the social and economic aspects of music. Also that these technical advances are laying a foundation for a revolutionary change in the actual art of music.

These changes are discussed with as little technicality as possible so that the music lover who is not a technician will have no trouble in understanding them.

It is a book, then, for those who are interested in the relationship between sound and the electrical field, and as such it is of interest to both the technician and the uninitiated.

**LA MODERNA SUPERETERODINA**, by D. E. Ravalico. Published by Heopli Editore, Milan, Italy; 1936. Size, 5 x 7 1/2 ins., 365 pages.

This is the 2nd edition of this book and for those who read Italian, it will be found of exceptional interest. It contains a wealth of new information and innumerable drawings of circuit elements and complete circuits. Several commercial receivers are extensively treated. It is of interest to American readers particularly since the tubes used in the sets described are mainly American types.

**RADIO OPERATING QUESTIONS AND ANSWERS**, by Nilson & Hornung. Published by McGraw-Hill Book Co., Inc.; 1936. Size 5 1/4 x 8 1/4 ins., 427 pages. Price, \$2.50.

The 6th edition of this long-popular work is very up to date. In this edition, 100 new questions on radio law, transmitting, receiving, and general theory have been added, bringing the text up to all the current requirements for applicants of Government licenses. These additions have been made necessary by recent advances in the art, and the possessor of the 6th edition will be able to keep right up to the minute on the latest in the game.

**BOOK SERIES FOR THE BEGINNER**. Published by Radio Publications, 99 Hudson St., New York. Uniform format: size 4 3/8 x 6 3/8 ins., 32 pages. Price, 10c ea.

**HOW TO BUILD 4 DOERLE SHORT-WAVE RECEIVERS**. No. 1.

In this book are described 4 of these popular receivers, with all constructional details included. Also, a power pack for A.C. operation is included.

**HOW TO MAKE THE MOST POPULAR ALL-WAVE 1- AND 2-TUBE RECEIVERS**. No. 2.

This book describes 6 receivers, including both battery and line power models, that are of great interest to the experimenter. Among these sets is a very effective 2-tube, battery-operated portable outfit.

**ALTERNATING CURRENT FOR BEGINNERS**. No. 3.

A simplified discussion of some of the major theories of A.C. Also included are many experiments which may be performed with this type of power.

**ALL ABOUT AERIALS**. No. 4.

Many interesting facts about the erection calculation, and tuning of antennas are presented in this book. A complete chapter is devoted to discussion of transmitting antennas, which will be of practical help to the amateur. A glossary of technical terms is also included.

**A TREATISE ON PRACTICAL WAX RECORDING**

The Universal Microphone Co., Ltd., has recently brought out a booklet written by Everette K. Barnes, Recording Engineer. This work covers very completely the field of wax-disc recording. The most minute instructions are given on how to obtain the most perfect results with this type disc. The beginner should have no trouble in following and understanding perfectly the clearly written and well illustrated text. Some of the sections include a description of the wax, details of the shaving process, studio and recording technique, descriptions of recording machines, and a description of the finishing processes whereby the original wax is transformed to the finished records.

While the booklet is written for the beginner, and as such is very detailed, nevertheless the more advance student of recording will find many points of interest, since it is authoritatively written by an acknowledged expert in the field.

Write to *Radio-Craft* for your copy—the price is 50c; ask for book No. 1091.

**NOW - BETTER VALUE THAN EVER!**



No. 405A

**New Price \$8.75**

(WAS \$9.95)

**DEPENDABLE OHMMETER**

Save money on this wonderful eight range instrument! Ohmmeter O-1000 and O-100,000 Ohms, measures less than 1/4 ohm. D'Arsonval moving coil meter, guaranteed accuracy of 2%. Voltmeter scales O-2.5; O-25; O-125 and O-750. Milliampere ranges O-2.5 and O-125. Complete with case and self-contained batteries. See it at your jobber's.

**NEW MODEL #410 MASTER MULTITESTER**

Amazing new instrument has 6 ohm-meter ranges, 1/4 Ohm to 40 Meg-ohms; 5 capacity ranges, .001 to 300 mfd.; 5 A.C.-D.C. voltmeter ranges. Uniform, highly accurate scale on both A.C. and D.C. Six A.C. and D.C. current ranges including 2 1/2 Amp. range. Measures power level in Decibels and Inductance and Impedance. Accurate at all frequencies.

Many improved features make this instrument indispensable for present day service needs. Low priced. Send for special bulletin at once. Dept. RCs.

**RADIO CITY PRODUCTS CO.**  
88 Park Place, New York City

**5-TUBE SUPER KIT**

456 K.C. 15 to 50 meters  
200 to 550 meters

The kit consists of: 1st I.F. Transformer, 2nd I.F. Transformer, 2 Gang Condenser, Chassis Pan, Broadcast Oscillator Coil, Short Wave Oscillator Coil, Band Change Switch, Broadcast Antenna Coil, Short Wave Antenna Coil, 6 Sockets, Electrolytic Filter Condenser, By-Pass Condensers, Padding Condensers, Resistors, Wire, Transformer, Hardware, Schematic Drawing furnished.

With 6 1/2" Speaker **\$5.95**

With 8" Speaker **\$6.95**

Add 50c for 25 cycle

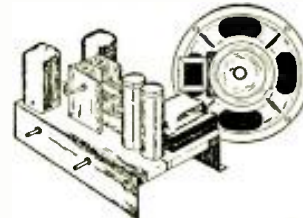

**7-TUBE SUPER KIT**

Kit Includes: ANTENNA COIL; R.F. COIL; OSCILLATOR COIL; 1st I.F. COIL; 2nd I.F. COIL; 3-GANG TUNING CONDENSER. Price **\$1.95**

Schematic circuit diagram for A. C. and Auto Receiver furnished.



Send enough money for parcel post or we ship by express collect.

Write for **FREE RADIO PARTS Circular**  
**ARROW SALES CORPORATION**  
631 Washington Blvd., Chicago, Illinois

Please Say That You Saw It in RADIO-CRAFT

## ESSENTIAL HOUSEHOLD APPLIANCES

### Ultra Violet Sun Lamp \$3.95

#### WITH CARBONS AND GOGGLES

Sunshine—Man's greatest benefactor—now in your own home. Good for children; good for grown-ups—especially on damp, dreary days. Provides same benefits as expensive hospital lamps. Safe and simple to operate. Automatic shutoff prevents over-exposure. For use on 110 volts, A.C. or D.C. 1000 watts. 15" high by 12" diam. finished in antique silver. Heavy metal base prevents tipping. Complete with instructions, carbons and goggles. Shipping wt. 6 lbs.



### HOOVER Vacuum Cleaner REBUILT Like New \$14.95 GUARANTEED

These fine machines are UNCONDITIONALLY GUARANTEED FOR 12 MONTHS. Thoroughly conditioned to standards of new machines. All moving parts which show the slightest wear are replaced with new ones. New bags, brushes, cords, handles and other parts are supplied. Even the chassis itself is repainted and polished.

The HOOVER cleaner is a powerful suction machine with a revolving brush which beats as it sweeps. Requires but a drop of oil a month—no other attention. REMEMBER, it's GUARANTEED! You'll have no grief with this machine. Shipping wt. 24 lbs.

ATTACHMENTS: comprising suction-coupling unit, extension rod, long suction hose, upholstery nozzle, upholstery brush and radiator nozzle \$5.50 additional

We issue no Catalog—Order directly from this page

100% Satisfaction Guaranteed. Send Money Order or Certified check. C.O.D. shipments require a 20% deposit. Immediate Service—No Waiting.

**HUDSON SPECIALTIES CO.**  
40 West Broadway New York, N. Y.

### CLASSIFIED ADVERTISEMENTS

Advertisements in this section are inserted at the cost of twelve cents per word for each insertion—name, initials and address each count as one word. Cash should accompany all classified advertisements unless placed by a recognized advertising agency. No less than ten words are accepted. Advertising for the September, 1936, issue should be received not later than July 6th, 1936.

#### A.C. AUTO GENERATORS

TURN SCRAP INTO MONEY. AUTOPOWER SHOWS you how easily and economically auto generators can be converted into A. C. or D. C. generators and D. C. motors. 2 to 1000 volts; for sound, radio, power, light, or welding. No previous experience necessary—complete information all in new book, with simple instructions and illustrations. Endorsed by thousands. Only \$1.00 postpaid. Autopower, Inc., 414-C S. Hoyne Ave., Chicago.

#### HELP WANTED

TECHNICAL HELP WANTED—MEN BETWEEN the ages of 21 and 45, capable of installing, operating, maintaining, and servicing Public Address Systems. For part time work in local territory. Experience preferred but not essential. Radio Dealers, Servicemen, etc., can qualify. State age, experience, territory desired and salary (per hour) expected. Amplifier Co. of America, 20 West 22nd St., New York City.

#### RADIO

RADIO ENGINEERING, BROADCASTING, AVIATION and police radio, servicing, Marine and Morse Telegraphy taught thoroughly. All expenses low. Catalog free. Dodge's Institute, Pine Street, Valparaiso, Indiana.

#### TELEVISION

TELEVISOR \$15.00, \$6.00, KIT \$10.00, \$4.00. ARTHUR Max Pohl, 2134 Palms, Detroit, Mich.

## THE IMPORTANCE OF INTERLACED SCANNING

(Continued from page 79)

TABLE I

1. A much lower scanning speed.
2. A smaller eye strain.
3. A faster permissible motion of the image.
4. The elimination of the picture "flash" when the eye winks.
5. A higher fidelity of the probable image when using a condenser-coupled electrical amplifying system.

In other words, *offset scanning* is an engineering science. It is a very important part of a profound knowledge of television. It can not simply be casually adopted in its most unpleasant form by engineers if it is expected to yield suitable results. It is easy, when scanning electrically, to simply interlace the lines of any 2 alternate picture scans to obtain the well-known "2 spiral effect" (of the mechanical scanner). While such alternate interlacing gives a higher fidelity of the received image, it is only because such observations are being made for the first time by these particular engineers concerning the advantages of the "line waveform interposition of different lines" (or interlaced scanning) in television signals. This simple single offsetting reveals the advantages of a small amount of waveform interposition while suffering an optical disadvantage in the scanning system itself, and therefore these engineers are going to a higher and higher number of scans per second. It has been unpleasant to listen to some engineers speak of the number of scans per second as though television engineers had frequently to "burn"; and fidelity so fine as to necessitate practically putting the image out of focus in order to avoid unpleasant sharpness! Such is definitely not the case, and we must conserve every spot of the television picture and cause it to recur as infrequently as possible as long as we retain a thoroughly acceptable effect. In other words, using ordinary American business intelligence with our engineering, we must make our picture definition cost us as little as possible.

### CAUSES OF FOGGED IMAGE

Now the reason for picture line frequency interposition in television can be illustrated very simply:—The probable image is a person's face—that is, although we must resolve every conceivable type of image, the human face is the most probable. Therefore, the scanning system producing the *probable frequency* will probably develop this most probable frequency by scanning a face. The face, if traced with an ordinary simple sequence (or non-interlaced) scanning system shows a practically similar waveform sequence in the electrical system, for each line-tracing across the forehead. The low-frequency (or shadow) variation is approximately the same in each case, and therefore, the average voltage developed in an alternating current amplifying system will develop in a general direction which will alter the effective bias on the control-grid in the amplifying system. Therefore, any system using condensers, or a so-called "condenser-resistance coupled" amplifier, will yield spurious shadows in the vicinity of any repeated waveform sequence which is either lighter or darker than that produced at zero signal level. For example, if each successive signal increases the charge in the coupling condenser, which does not have time to completely leak off between signals, then a continuous discharging current will cause a general change in brilliancy in that zone of the picture where these effects occur. Thus, the picture assumes a striped appearance having different zones of light and dark shadows.

By reference to Fig. 1A and B, we can easily see that the successive signals from tracing a forehead of a person will produce a change in effective bias voltage on the control-grid of the electron relay, for the condenser is charged each time, and does not have time to fully discharge, and again balance the circuit to give normal bias on the control-grid. Hence, zones of whiteness will have black shadows, and zones of blackness will have white shadows, and at the end of the zone, gray shadings will appear where white is intended. In photography, we would call this a "fog" on the picture. So let us classify this effect in television as either a "(1) scanning or (2) electrical fog," for it is due to either (1) improper scanning or (2) improper amplifying technique.

By the use of a so-called "battery balanced

amplifier," or devices that do not involve transformers, inductances or condensers directly in the amplifying system, we can eliminate these undesirable effects from the picture. Such amplifying systems have so far been expensive, and somewhat unstable in operation. To overcome this unpleasant effect with an amplifier is the task of the television engineer *when he is working on amplifiers*, but when the television engineer is *working on scanning systems*, then he should reduce this unpleasant effect with the proper scanning system in order that (1) "scanning fog" may be eliminated; and (2) "electrical fog" isolated and treated by itself.

A noticeable improvement in picture fidelity is immediately effected when a television engineer omits every other line on one scan of the image and inserts it with the next scan, alternately interlacing or off-setting, for then the number of repetitions of "forehead signal" or "hair signal," or "mouth signal" are reduced by 50 per cent and "interlaced" with other signals. Optically, this "shutter" or "lattice work" appears to move within itself, and the scanning system really has to trace very rapidly to effect a pleasant optical sensation. Now, if we off-set 3 times so that we leave out every 2 adjacent lines, then a much more acceptable optical effect is achieved while tracing the picture at a fairly low scanning speed, and at the same time a lesser number of repetitions of the same type of signal occur in sequence; thus, only a few lines have "forehead signal" before they are followed with the signal produced from the eyes, or the teeth, etc.

Visible improvement in fidelity continues as we increase the number of offsets, but the optical advantages of off-setting decrease if we follow too-rhythmic interlacing, for then we appear to see an apparent motion between the coarse-grained pictures that are interwoven. We have observed (in our laboratory, where we have exhaustively studied this particular phase of television problems over a period of years) that the best optical and electrical effect is obtained when we scan sections of the picture as widely separated as possible with each successive tracing of a line of the picture.

### "RHYTHMIC—UNRHYTHMIC" SCANNING

Thus, we scan first a line at the top of the picture, and then at the bottom, but now if we should alternately go back to the top and then the bottom and weave in toward the center, the effect would be good in the elimination of electrical fog shadows, but the optical apparent motion or flickering wiggle effect would be rather poor, for the picture parts would appear, at low scanning speeds, to close in toward the center repeatedly in mechanical fashion. Therefore, after we have scanned the top and the bottom line, we move toward the middle of the picture and scan a line there, and since it has been two intervals before we have been near the upper part of the picture, we now scan a line half way between the center of the picture and the top line of the picture, and then we move back to a line mid-way between the center line of the picture and the bottom of the picture. Now we have completed what we call a "cycle in scanning," or in other words, we have skipped as widely as possible over the picture. Now we repeat the same general effect, filling in the lines that have not been scanned, and in this fashion, we continue until we have scanned every line of the picture with the scanning spot. The effect defeats the eye's tendency to follow the scanning spot, so that flicker and apparent motion are practically nullified at very low scanning speeds. Using very high brilliancy, we have been enabled to completely eliminate any serious visible flicker or wiggle or "crawl" with this "rhythmic—unrhythmic" arrangement.

### DEFINITION MULTIPLICATION

Now great further advantage is obtained if on the next complete cycle of scanning events, we cause the lines to be "half-off-set" so that they trace in the manner shown in Fig. 2A. The center of definition has now shifted to the point where absent lines formerly existed, and this "invisible offsetting" greatly reduces the apparent grain in the picture so that it can be made to appear extremely smooth. We call this "invisible offsetting" *definition multiplication*, for in effect, it takes a fixed lattice work, and puts it into a state of motion. This effect may

Please Say That You Saw It in RADIO-CRAFT

be improved with two "invisible offsets" in the manner shown in Fig. 2B. Therefore, by operation of these two methods of scanning in co-operation, we achieve both the advantages of definition multiplication and line frequency interposition; or in other words the best optical effects and the best electrical effects. Hence, by the application of such a system we can say, "we have made television scanning progress."

That is, we can scan and produce the optimum definition with the minimum speed, with the minimum electrical frequency, and the cheapest possible electrical amplifying systems; and with devices which might otherwise have too much inertia for improperly-engineered, higher-speed systems attempting to produce the same definition at the same frequency.

The means by which these methods may be accomplished are numerous. It is not confined to mechanical scanning, and they may be just as easily applied to electrical scanning. If an electrical scanner like the iconoscope has an image-tracing line sequence which traces the lines in a manner giving the best line frequency interposition for the probable image by offsetting, then the cathode-ray receiver may pick up this tracing signal and trace similarly. It is only necessary that they trace in synchronism and the best visible and electrical effects are, therefore, easily obtained. With a mechanical system, this is simply incorporated in the mechanical design. While we hear much of the glory of electrical scanning these days, and the systems are, undoubtedly, attractive,

their fidelity "per spot" is far below that of a good mechanical system; and unless electrical scanning systems can reveal more notable advances and improvements, the mechanical systems still appear to play a serious part in eventual television—particularly, where large pictures are desirable. Lamb's polarizing film now offers immense new possibilities to large-screen mechanical systems giving extremely high definition, for the screen itself may be used as the light valve. It is quite possible that an electrical transmitter like the iconoscope can be made to work successfully with a mechanical receiver, but whatever system is adopted as long as it scans, electrical advantages are obtained by scanning the probable image so as to effect line frequency interposition of the dissimilar waveforms, and to secure improved definition and agreeable effects with the properly coordinated sequence of scanning and invisible offsetting.

Television is a broad science, and it is not "solved" by the contribution of any one type of tube, or a scanner, or any one of its component parts. Like all the other engineering arts, it has many phases. Since the art is young, we are all occasionally inclined to overlook its enormous scope. Therefore, we must choose any standard of scanning at this time with a more scientific attitude than that with which we approached experimental standardization some years ago when single-spiral scanning discs were adopted while now all turn directly to offsetting. Standards unwisely selected will be expensive, and as distressing as the 25-cycle hydro-power systems are in the midst of 60-cycle practice.

## TELEVISION IN GERMANY

(Continued from page 83)

working with Telefunken. Prof. Schroter from the same house proposed in 1926 to relay television transmissions on ultra-short waves.

To-day, the circle of firms and specialists has increased tremendously. Manfred von Ardenne was the first who successfully used the cathode-ray tube in 1930 for a television receiver. Since that time, great advancements have been made whereby all firms under the direction of the Deutsche Reichspost are inter-connected so that television in Germany has moved ahead of the world in several respects.

### TRANSMITTER

Today, the following characteristics are used in Germany: 180 lines and 25 pictures per sec., (i.e. 40,000 points per picture); modulation nearly 100 per cent; dark 25-35 per cent; synchronism by interruption at the end of each line, using 5-7 per cent of the line. This results in a modulation frequency of 1,000,000 cycles.

The transmission organization in Germany is tightly held by the Deutsche Reichspost, which at present has 2 stations on the air. First is the new television transmitter in Berlin-Witzleben, which was erected in order to replace the old one which burned down in August 1935. Figure A shows two sections, at the right is the image transmitter with a power of 15 kw., which works on 44,300 kc. (6.772 meters), while at the left is the tone transmitter with the same power, the frequency of which is 42,500 kc. (7.06 meters). The programs are sent out as follows: daily from 9 a.m. to 11 a.m. television experiments; 5 p.m. to 7.30 p.m. music; from 8 p.m. to 10 p.m. both transmitters relay the official television program, and from 10 p.m. to midnight only the sound transmitter works.

Because Germany plans to set up a complete network of television transmitters, the most favorable points for these stations have to be elected. For this purpose the Deutsche Reichspost has made a transportable television transmitter, which is built up on 20 heavy trucks. Figure B shows some of the trucks. The train of cars transports 2 ultra-short-wave transmitters, movie scanning transmitter, diesel motors, cooking and housing facilities for 30 engineers, etc. At first, the transportable transmitters went to the Brocken mountain and here sent out a good signal up to a distance of 62 mi. After conclusion of these measurements the transmitter traveled to other German mountains. In the meantime preparations for the construction of the main transmitter on the Brocken Mountain, which is connected with cable to the Berlin television studios has begun.

After many expensive experiments, which have

been undertaken in the labs. of the television and radio factories a good television receiver has been developed. The signals of both picture and sound are fed from the aerial to an R.F. stage, and are then mixed in the 1st-detector (mixer) with oscillator frequency, which is about 1 mc. different from the receiving frequencies. This produces two I.F. signals because of the difference in frequency between the sound and image signals and both are separately amplified. The I.F. of the sound transmitter runs through an I.F. amplifier, and then passes to 2nd detector (a diode) and the power audio stage. The image I.F. runs through an aperiodic I.F. power stage, where it is amplified tremendously. Now the image currents are rectified and fed to the cathode-ray tube.

In Fig. C we see a modern German television-receiver, made by Fernseh A.G. In this set it is only necessary to tune in the sound transmitter and then the picture is also tuned in right. The knobs, which are to be seen on the right, and which are covered by the hinged cover serve to adjust the receiver and the sweep oscillators. These are only changed when the cathode-ray tube is replaced.

The current consumption of the television receivers, which are supplied for 110 and 220 V. A.C., lies between 250 and 400 W., according to the design. The following firms produce television-receivers with cathode-ray tubes: Telefunken; Fernseh AG; Manfred von Ardenne with C. Lorenz A.G.; Radio Ag. DS. Loewe; CH. Muller & Co. (Philip Konzern).



The left side of the Lorenz A.G. set.

Please Say That You Saw It in RADIO-CRAFT

## NEW Extension Auto Speaker



Model 930

for Camping, Touring, etc.

- 8" Nokoli Speaker gives electro dynamic performance yet draws no current from battery.
- Cabinet easily taken apart to make proper connections to the universal transformer which matches all tubes.
- Any service man can easily and inexpensively furnish proper length cord and plug in connection for automatically disconnecting car speaker and connecting extension speaker.

Here is a Big Summer Item

Our special low price enables you to buy for \$9.30 to make it a great leader. List \$12.50

Write for further particulars, complete catalog and name of your nearest distributor.

WRIGHT-DECOSTER, Inc.

2251 University Ave., St. Paul, Minnesota

Export Dept.—M. Simons & Son Co., New York.

Cable Address: "Simontrice"

Canadian Office, Wright-DeCoster, Inc., Guelph, Ont.

## CORNELL-DUBILIER

CONDENSERS  
ARE



## THOROUGHBREDS

COMPACT • EFFICIENT • DEPENDABLE

Cornell-Dubilier capacitor units are thoroughbreds to the Nth degree, in eye appeal, mechanical and electrical characteristics.



On your job take this hot tip. Put your condenser money on C-D's. They can always be depended upon to lead the field in QUALITY, PERFORMANCE and SERVICE. Bank on a thoroughbred and increase your business.

Full details on the complete Cornell-Dubilier condenser line furnished upon request. Write for catalogs 128 and 131A

WET AND DRY ELECTROLYTIC  
PAPER • MICA • DYKANDOL

## CORNELL-DUBILIER

CORPORATION

300 BROADWAY  
NEW YORK

# NEW 10 CENTS RADIO BOOKS



### ALL ABOUT AERIALS

In simple, understandable language this book explains the theory underlying the various types of aerials; the inverted "L," the Doublet, the Double Doublet, etc. It explains how noise-free reception can be obtained, how low-impedance transmission lines work; why transformed lead-ins are used. It gives in detail the construction of aerials suitable for long-wave broadcast receivers, for short-wave receivers, and for all-wave receivers. The book is written in simple style. Various types of aerials for the amateur transmitting station are explained, so you can understand them.

### ALTERNATING CURRENT FOR BEGINNERS

This book contains everything to give the beginner a foothold in electricity and Radio. Electric circuits are explained, Ohm's Law, one of the fundamental laws of radio, is explained; the generation of alternating current; sine waves; the units—volts, amperes, and watts are explained. Condensers, transformers, A.C. instruments, motors and generators—all these are thoroughly discussed. Housewiring systems, electrical appliances and electric lamps.

Here are some of the practical experiments which you can perform at home. Simple tests for differentiating between alternating and direct current; how to light a lamp by induction; making a simple electric horn; demagnetizing a watch; testing motor armatures; charging storage batteries from A.C. outlet; testing condensers with A.C.; making A.C. electro magnets; frying eggs on a cake of ice; making simple A.C. motors and many others.

Each book contains 32 pages, profusely illustrated with clear, self-explanatory diagrams. It contains over 15,000 words of clear legible type. It is an education in itself and lays the ground-work for a complete study of radio and electricity.

If you do not think that this book is worth the money asked for it, return it within 24 hours and your money will be instantly refunded.

**RADIO PUBLICATIONS**  
99A Hudson Street, New York, N.Y.

RADIO PUBLICATIONS, 99A Hudson Street RC-836

Please send immediately books checked:

- All About Aerials, Book 4.....10c
  - Alternating Current for Beginners, Book 3.....10c
- I am enclosing .....c; the price of each book is 10c; (Coin or U.S. Stamps acceptable.) Books are sent postpaid.

Name .....

Address .....

City ..... State .....

## THE LATEST RADIO TUBES

(Continued from page 84)

filament current. It has the same physical dimensions and the same base connections. The chart, Fig. 3, shows the plate characteristics. This tube will doubtless find wide application in portable receivers, due to the economical current requirements. It is very similar to the 950 in this respect, although the operating characteristics are somewhat different.

### 1F4 characteristics

Filament voltage (D.C.) .....	2.0V.
Filament current .....	0.12-ma.
Plate voltage .....	135 V. max.
Screen-grid voltage .....	135 V. max.
Control-grid voltage .....	-4.5 V.
Plate current .....	8.0 ma.
Screen-grid current .....	2.6 ma.
Plate resistance .....	0.2-meg.
Amplification factor .....	350
Mutual conductance .....	1,700 micromhos
Load resistance .....	16,000 ohms
Undistorted power output .....	340 milliwatts

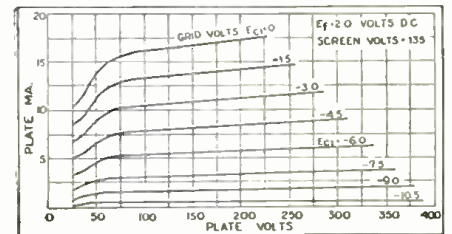

Characteristics of the 1F4 tube.

## THE OPTO-MECHANICAL SYSTEM OF TELEVISION

(Continued from page 88)

for any transmission, regardless of number of lines per image or images per second.

As to the question of cost, I cannot, of course, tell what price cathode-ray receivers will retail for, though rumors set their prices between \$350 and \$750. But I can state definitely that our television receiver, in a console cabinet with screen, and capable of tuning-in all-wave radio broadcasts as well as television images will be sold for about \$225 or less.

But first cost is not the entire cost of any radio set. Tubes need replacing from time to time, and in my set there are 6 to 12 fewer ordinary tubes, to say nothing of the extremely costly cathode-ray tube—which I do not use. Cathode-ray tubes will vary in price according to the size of the image which they will produce. Those capable of showing pictures approximately 6 ins. square may sell, it is said, for as little as \$5.00 and may last for 4,000 or 5,000 hours, while those producing larger pictures—say a foot square—will probably cost from \$25.00 to \$75.00, though their life may be considerably shorter.

The only elements needing replacement in my system are the auto headlight bulb, which costs 10 cents, and the light-modulator tube, which will sell for a dollar or less. Both these elements will last for 5,000 hours or more. The scanning disc and motor need never be replaced. My system uses only normal radio receiver voltages—less than a tenth the voltage required by the cathode-ray type. Its fewer tubes and lower "wattage" will also result in saving current and consequently lower electric bills, for the 1-100th horse-power motor uses far less current than one ordinary electric light bulb!

There is only one more control on this set than on ordinary broadcast receivers, for a component of the signal is used to maintain synchronism. The addition control is to be used for framing the picture when first tuned in. This control makes our receiver far more flexible than the cathode-ray type, for it is doubtful whether they will be able to receive programs sent out by transmitters using any type of scanning other than that to which they have been set at the factory, while our sets will receive any number of lines, from 180 to 405, whether straight or interlaced scanning is used. It does not seem practical to me that a set should be as limited as the cathode-ray type, any more than that a radio receiver should be limited to one of the two major networks, and be incapable of receiving the other chain, or the independent stations.

With the cathode-ray tubes thus far demonstrated, the picture has been limited to a square inscribed upon the circular end of the tube, and the length of each cathode-ray tube must be approximately 3 times its diameter, which creates the problem of building a cabinet big enough to house the tube if a large picture is desired. Newer cathode-ray tubes may be sufficiently brilliant to project a picture upon a screen, but these would probably use even higher voltages and have shorter life, due to the greater activity of their radio-active end screens. Using my mechanical system, we are now projecting a 14 x 16 in. picture on a screen built into a small console cabinet.

Most mechanical scanners have hitherto produced pictures of only 60 lines, while the cathode-ray tubes are stressing images of more than 300 lines. The new model, which I am bringing out shortly, will project 180-line images, or 9 times the detail formerly secured with a disc, and more than half the lines used in cathode-ray work. In other words, it is theoretically possible to view a cathode-ray image at 5 ft., while the same effective detail would be had at 10 ft. with any system. However, it is necessary that a cathode-ray scanner use twice as many lines as a mechanical scanner in order to get equally good images, for the flying spot remains uniform in size in my system, while it decreases in size when modulated downward on a cathode-ray tube, resulting in black spots which

must be filled in by closer scanning.

Furthermore the usual cathode-ray image is "peasoup"—green and black, while the images our system provides are black and white. Although experiments are being conducted to secure black and white images with the cathode-ray tubes, to the best of available information very uneven results have been thus far secured. Let me again stress the brilliance of an automobile headlight bulb, 90 per cent of the light of which actually reaches the screen used in our system, as compared with the fluorescence of the end-screen of the cathode-ray tube. This is like a comparison between a powerful electric light and a kerosene lamp.

Both systems will, in my opinion, probably use 24 effective frames per second, being thus enabled to transmit programs composed of standard motion-picture film in addition to direct pick-up of studio and outdoor programs.

Apparatus now under construction in our laboratory includes a receiver capable of reproducing straight or interlaced scanning images from 180 to 1,000 lines per frame, and automatically synchronized with any transmitter. The scanning disc has been reduced from its former size of 5 ins. to 2 ins., making for silent operation and greater economy, both in production and use. The flexibility of this new apparatus will fit it into the rapidly changing television broadcast situation whatever the ultimate number of lines and frames may be.

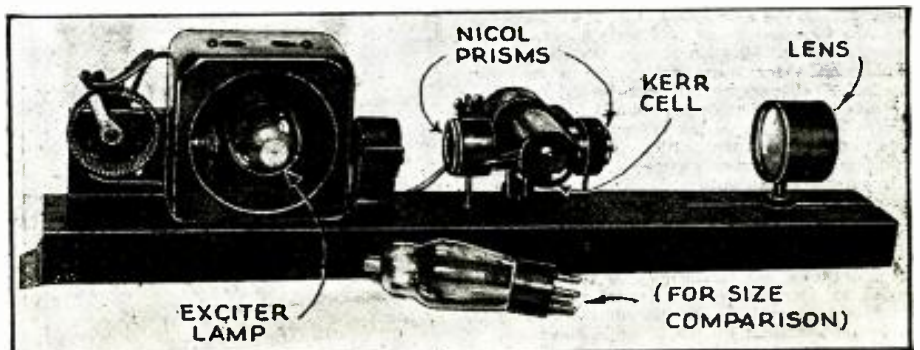

A complete set-up of exciter lamp in its reflector, Nicol prisms and Kerr cell and optical system for image projection.

Please Say That You Saw It in RADIO-CRAFT

## MAKING A MIDGET MULTI-PURPOSE METER

(Continued from page 88)

held together with 2-56 screws. The panel, on which the lettering is engraved, is of course removable and all parts are fastened to it so that the "works" may be removed as a unit. The box may be assembled to fit as closely as possible, then all edges and corners should be sanded off smooth. The best finish is a dull one, obtained by rubbing with very fine sandpaper, then waxing. When the panel has been drilled, an exact scale plan should be drawn on paper. The engraver will follow this exactly, so make sure it is right. No panel layout for engraving is given because most builders will want to use their own wording.

The selector switch is the heart of the instrument. Dimensions are given in Fig. 2 for this unit. Do not make it any larger or it will not fit in the box. When the bakelite disc has been cut out, the 20 holes around the rim are drilled and tapped for 2-56 round head screws. These are then screwed in tightly and the heads all filed off flat. The connecting wires are soldered directly to the other end of the screws.

The shaft is of 1/4-in. brass with a hole drilled and tapped in one end for a 6-32 screw. This screw holds the 5/8-in. insulating washer to which are fastened the two bronze contact arms. One arm is connected to the shaft, while contact to the other is by means of the flexible lead. A standard 3/4-in. threaded bushing serves as the bearing and also holds the unit to the panel. A strong bronze spring fastened to the center shaft serves to stop the switch arms when they are centered on the contact. This is done by an indentation on the outer end of the spring, which drops into holes drilled in the bakelite disc.

The wiring diagram should be studied, and pieces of bare No. 18 wire soldered to the proper contact points, leaving them long so they may be cut to size after assembly.

The wiring is all done with No. 18 tinned bare wire over which pieces of small diameter spaghetti

are slipped. This provides ample insulation in the close quarters.

After the multipliers are connected, the shunt panel is fastened to the bracket which holds the meter. The shunts are pieces of resistance wire taken from old wire-wound resistors, and should be cut to size by experiment. This is easily done by connecting the meter across the terminals of another ohmmeter, making sure to open the circuit when the shunt is not in place.

The wiring of the rectifier circuit is now finished and two flexible leads are taken from the proper points in the circuit to connect to the battery which is a standard 2-cell midget, the smallest 2-cell battery generally sold.

Before considering the instrument finished it should be checked against a standard, and any inaccuracies of more than about 3 or 4 per cent corrected.

### LIST OF PARTS

- One engraved panel, 3/16-in. thick;
- \*One milliammeter with universal scale, 0-1 ma., 2 ins. dia.;
- One Radio City Products W.W. resistor, 5,000 ohms;
- One Radio City Products W. W. resistor, 50,000 ohms;
- One Radio City Products W. W. resistor, 0.25-meg.;
- One Radio City Products W. W. resistor, 0.75-meg.;
- One midget potentiometer, 3,000 ohms;
- Two Eby pin tip jacks;
- One Cornell-Dubilier midget paper condenser, .01-mf.;
- \*One meter rectifier;
- One I.R.C. resistor, 5,000 ohms, 1/2-W.;
- One case, 4 1/2 x 1 3/8 x 3 3/8 ins. wide; wire, hardware, knobs, etc.

\*Name of manufacturer supplied upon request.

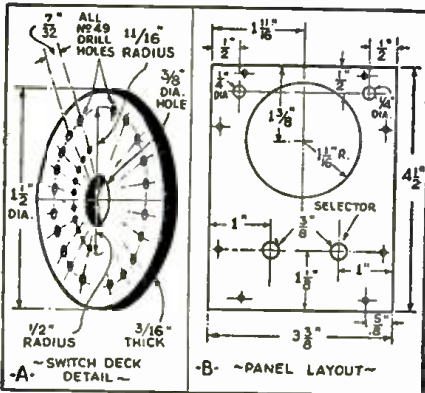

Fig. 2. Details for drilling the switch disc and the panel of the instrument.

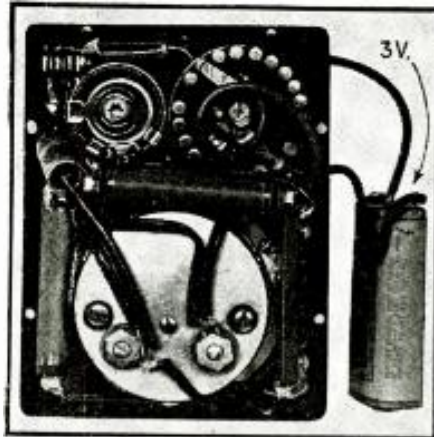

Fig. B. The works of the unit.

## HOW TO INSTALL A WIRED AUDIO P.A. SYSTEM

(Continued from page 84)

into a local source of power and the lines for the unit run directly from the control unit through an ordinary pair of telephone wires and tapped at each unit down the line. As the volume of each line is independently controlled from the master control units, each set of speakers may be operated at the desired volume, regardless of the distance from the operator.

In Fig. 1, we see a view of a hotel layout where a P.A. system has been installed for a gathering of about 1,800 people. Five speaker units (units marked A), each capable of carrying 10 W., were installed to provide coverage. This coverage, immediately adjacent to the speakers but in the center of the room, was unusually high and practically no sound existed. Several dead spots underneath both balconies were also noticed and the balconies were absolutely dead. In the top balcony no word of the speakers was understood.

The new system was installed in this same room (units marked B in Fig. 1). Here 10 speakers were placed, each capable of carrying about 4 W. These speakers were installed in upright columns and the sound was thoroughly diffused before striking the ears of the audience.

Figure 2 is an illustration of the sound column for each speaker. Each column was 20 x 20 ins., made of 3/8-in. laminated board, glued and nailed

together, and was 5 1/2 ft. tall. No attempt was made to produce an exponential type horn. The speaker was mounted in a baffle half-way down the column and was pointed vertically. At the top of the column, with its rim projecting about 2 ins., was a diffusing cone made of heavy metal. Care should be taken in streamlining the top-most part of this cone, otherwise, too much sound will be lost and too much reverberation at low frequencies will take place.

Going back to Fig. 1, we notice that those speakers installed in the balcony were operating at much lower volume than the speakers on the main floor. However, if any complaint had been received during the addresses, the operator had controls at his finger-tips for raising or lowering the volume of any group of speakers (3 speakers were operated from 4 lines in this set-up).

In the forthcoming issue of *Radio-Craft*, the writer will give constructional data, schematic diagrams and the procedure for building, installing and operating this new and revolutionary type of P.A. system that has an almost unlimited field for application, from the smallest systems to the largest.

This article has been prepared from data supplied by courtesy of Dencose, Inc.

Please Say That You Saw It in RADIO-CRAFT

**YOU BELONG IN THIS PICTURE**

**OUTDOOR SUMMER CALLS FOR Magic Magnet Extension Speakers**

The tremendous extension speaker market, practically untapped and highly profitable, is opened to the servicing field for the first time on a practical basis by Cinaudagraph Magic Magnet Speakers.

Every owner of a radio receiver, (and there are some 22,000,000 in America!) is a prospect. For porch, garden, bedroom, for every spot not reached by the set! They're a cinch to sell . . . these Magic Magnet Speakers with their high fidelity characteristics, sturdy construction, and simple installation features . . . only two wires being required for hook-up.

Extension speakers have proven a boon in England. Why not here? Just try selling your customers on the idea. You will be surprised at the response.

Details sent on request.

**CINAUDAGRAPH CORPORATION**  
Speaker Division, Stamford, Conn., U.S.A.  
Dept. R.C.

## CINAUDAGRAPH

## Be a TELEVISION EXPERT

### LEARN TELEVISION with RADIO-NOW!

Great opportunity for experts in this amazing new industry. Recent developments in radio make television a certainty NOW. We teach you by our "on the job" method Radio and Television from beginning to end in our marvelously equipped labs and studios. You actually operate thousands of dollars worth of expensive equipment. You get expert instruction and skilful guidance by radio-television specialists.

### Demand for Television Experts

Television now perfected and ready for the market ON THE NEXT BIG BUYING WAVE. Business leaders predict new system television will require thousands of relay and broadcasting stations. Ultra-short waves will permit eighty thousand television stations in America alone.

GET IN NOW and build up with the world's next billion-dollar industry.

### 6 MONTHS THOROUGH PRACTICAL TRAINING

Qualifies for radio-telephone license (1st Class). Complete up-to-the-minute training in modern workable television equipment including the new cathode-ray. Practical experience in studio control room. Transmitter operation of Television Station WJVA. Employment assistance and upon graduation while training and upon graduation. Write for free book "Pictures On the Air" NOW!

### FREE BOOK

S. Q. NOEL, Pres. First National Television, Inc. Dept. C B

Power & Light Bldg., Kansas City, Mo.

Without obligation, send me postpaid FREE Illustrated Book—"Pictures On the Air", telling about new opportunities in television. I am 17 years or older.

Name \_\_\_\_\_

Address \_\_\_\_\_

**This SCREWDRIVER Actually GOES AROUND A CORNER!**

**FIXIBLE SHAFT SCREWDRIVER** permits access to screws in awkward places—actually works around a corner. Ideal for radio, refrigerator, automobile, electrical appliance, motor, machinery repairs. Shaft of laminated flexible steel wire; nickel-plated fittings; tempered steel blade; fluted wooden handle. **Order your FLEXIBLE SHAFT SCREWDRIVER today \$1.00 POSTPAID.**

**JOBBERS:** Write for Quantity Prices

**COMMONWEALTH PRODUCTS CO.**  
401 Broadway  
New York, N.Y.

## BOOKS

### To Help You Learn More About RADIO and AIR CONDITIONING



Illustrated at the right and left are two books in the Radio-Craft Library Series.

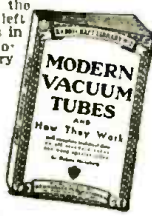

THE RADIO-CRAFT LIBRARY SERIES—a most complete and authentic set of Volumes—treats individually, important divisions of radio. Each book contains an average of 50 to 120 illustrations. The books are printed on an excellent grade of paper which makes the type easy reading.

#### All Books Uniform

The volumes in the RADIO-CRAFT LIBRARY SERIES are all uniform, 8 x 9 inches. Each book contains an average of 50 to 120 illustrations. The books are printed on an excellent grade of paper which makes the type easy reading.

#### Here Are the Series:

- Book No. 1  
**RADIO SET ANALYZERS**  
And How to Use Them By L. VAN DER MEL
- Book No. 2  
**MODERN VACUUM TUBES**  
And How They Work By ROBERT HERTZBERG
- Book No. 4  
**MODERN RADIO HOOK-UPS**  
The Best Radio Circuits By R. D. WASHBURNE
- Book No. 5  
**HOW TO BECOME A RADIO SERVICE MAN**  
By LOUIS MARTIN
- Book No. 6  
**BRINGING ELECTRIC SETS UP TO DATE**  
By CLIFFORD E. DENTON
- Book No. 7  
**RADIO KINKS AND WRINKLES**  
For Service Men and Experimenters  
By C. W. PALMER
- Book No. 8  
**RADIO QUESTIONS AND ANSWERS**  
By R. D. WASHBURNE
- Book No. 9  
**AUTOMOBILE RADIO AND SERVICING**  
By LOUIS MARTIN
- Book No. 10  
**HOME RECORDING AND ALL ABOUT IT**  
By GEORGE J. SALIBA
- Book No. 11  
**POINT-TO-POINT RESISTANCE MEASUREMENTS**  
By CLIFFORD E. DENTON
- Book No. 12  
**PUBLIC ADDRESS INSTALLATION AND SERVICE**  
By J. T. BERNSELY
- Book No. 13  
**ABC OF AIR CONDITIONING**  
By PAUL D. HARRIGAN

### BIG DISCOUNT OFFERED

When Five (5) Books or More Are Ordered, Deduct 20% from Your Remittance

**GERNSBACK PUBLICATIONS, INC.**  
99 Hudson Street, New York, N. Y.

#### MAIL THIS COUPON TODAY!

GERNSBACK PUBLICATIONS, INC. IC-836  
99 Hudson Street, New York, N. Y.

I have circled below the numbers of books in the RADIO-CRAFT LIBRARY SERIES which you are to send me, and have deducted 20% for ordering five (5) books or more. I have included my remittance in full, at the price of 50c each, when less than five books are ordered.

The amount of my remittance is..... (stamps, checks or money orders accepted). Circle numbers wanted:

1 2 4 5 6 7 8 9 10 11 12 13

Name .....

Address .....

City ..... State .....

All books are sent postage prepaid

## MECHANICAL vs. CATHODE RAY TELEVISION SYSTEMS

(Continued from page 79)

functions in common. They are primarily differentiated by the way in which they scan or sub-divide an object at the transmitter, and the form of scanning they employ at the receiver to reassemble the picture from the received electrical pulses. Therefore our first point of inquiry should be directed at the comparison of the two types of scanners.

### CATHODE-RAY AND MECHANICAL SCANNER FUNDAMENTALS

The cathode-ray system employs a large evacuated glass tube on the end of which is a fluorescent screen, and upon this screen a fine cathode-ray "pencil" paints a picture. The illumination comes directly from the power of the cathode-ray beam. The beam travels over a predetermined geometrical pattern under the influence of two spaced pairs of scanning electrodes. A number of large radio and electrical companies in the United States have been working on the cathode-ray system for the past 6 years and have spent vast sums on its development.

In the mechanical systems there is a physical motion of one or more parts. The light from a steady source modulated by a Kerr cell is projected from a moving optical element to a screen. The mechanical motions used are either rotary or oscillatory. The former has been generally abandoned because of the multiplicity of optical systems it requires and the resulting high cost, leaving for practical consideration only the oscillatory or vibrating type. The scanner shown in the heading illustration is the Priess scanner and is of the vibrating-mechanical type. Dr. de Forest has told me he believes it to be the only satisfactory high-definition scanner so far devised. (Additional illustration and description of this unit appear on pg. 123 of the August 1935, Television Number of *Radio-Craft*.—Editor)

In the following, I am setting down the claims made by the cathode-ray and vibratory-mechanical systems, in the hope that they will give the public an insight into the relative merits of the rival systems.

### DEFINITION

The quality of a television picture is dependent directly upon the number of areas into which the subject is broken, providing that the pictures are repeated with sufficient rapidity to give a smooth continuity. Other than the scanner itself there are 2 factors that limit the detail or the dot frequency. The first is the width of sideband that the Federal Communications Commission is likely to permit, and the second one is a technical limitation imposed by the amplifier in the receiver. This latter limitation is serious and for an amplifier of high gain within the low-cost class we might set its upper range at about 2 megacycles. Of course with time this range will be extended.

Both the cathode-ray scanner and the Priess mechanical scanner can be built to the upper limit of the amplifier range and beyond.

There is no real upper limit to the rate at which a cathode-ray tube can be made to scan, but this property is of little value because its practicability is blocked by the amplifier. Such a claim as "1,000 lines" is misleading, for the amplifier to which the tube must necessarily be connected will not pass more than 250 lines! And again, if such an amplifier could be built, the sidebands required would be so great that the Federal Communications Commission would hesitate about the allocation of such a huge slice of the ether to a single station.

As a practical matter therefore, the detail or quality of both systems is the same. Other systems which cannot meet this standard of quality, fixed only by the amplifier limitations, have no place in home television.

### PICTURE SIZE

The size of a cathode-ray picture is limited by the size of the evacuated tube which carries the screen upon which the picture is painted. Pictures 6 x 8 ins. and some 8 x 10 ins. are shown. Larger pictures about 12 x 14 ins. are produced by the combination of an optical system in conjunction with a tube operated on high pressures of 5,000 to 10,000 volts.

The mechanical system operates on a simple projection principle, that is to say that the field

of light subtends a solid angle whose apex coincides approximately with the vibrating optical element. Since this angle can be readily made 20 deg. (for a 5 deg. motion of the optical element on either side of the neutral strain position), pictures 3 ft. on a side can be projected at a distance of about 6 ft. from the scanner!

This difference in picture size, that is to say the inherently small size of the picture produced by the cathode-ray, and the large picture produced by the mechanical system is a point of very great importance. I do not believe—other things being equal—that the public will choose a small picture system when they have the opportunity of purchasing a large picture device. They have been trained to theater and home movies. These are the standards upon which their judgment is based. Can anyone imagine a typical movie fan spending an evening peering through an old-fashioned peep-hole machine of the variety found in the shooting galleries, in preference to enjoying a modern projected picture?

### PICTURE BRILLIANCY

The illumination of a cathode-ray picture is a function of the impact energy of a stream of electrons upon a translucent fluorescent screen.

The illumination of a mechanical picture is a function of the brightness of the steady source of light and the area of the vibrating optical system.

The factors that limit the brightness of a cathode-ray picture are of great interest. Since the screen must be translucent, the deposit of fluorescent material must be thin. If the voltage applied to the tube is pushed up to increase the brilliancy, the violence of the bombardment of the screen rapidly destroys it. Furthermore all of the power for the illumination must come from an amplifier that is flat from a low frequency to the limiting frequency of a scanned dot. This power is most expensive and requires a large amplifier output at peak pressures of several thousand volts. In other words, the limits are set by the burning-out of the screen on the one hand, and the cost of the apparatus for producing a very high voltage of broad band characteristics on the other. However, the brilliancy is adequate for the small-size pictures now produced, but is distinctly inadequate for a substantial optical expansion of the picture.

The mechanical system functions in an entirely different manner. The light is steady; and supplied from an inexpensive power source. Only a small amplifier power is required to modulate it; and this power is delivered at medium potentials. One limitation to the brilliancy is the intensity of the source. There is available an enclosed source that has a brightness greater than that of the disc of the sun. This lamp is small and inexpensive, and has a long life. (See the article, in this issue of *Radio-Craft*, by Dr. de Forest.—Editor) The second limitation is the area of the moving optical system upon which the beam impinges before being projected to the screen. Using the mentioned light source and a mirror of 3/16-sq. in. with an optical system of an overall efficiency of about 22 per cent, the illumination is adequate for a 3 ft. picture; smaller pictures are correspondingly brighter. The 3/16-sq. in. size mirror requires 1A. at 1/2-V. to drive it. Larger mirrors can be used with a corresponding increase of driving power.

The story is not told completely by merely comparative brightness. The quality of the light and its physiological effect enter. The picture produced by a cathode-ray tube is usually a green-gray. The picture produced from the mechanical system using a steady light source modulated by a Kerr cell is generally white-gray to white-black. The cathode-ray picture tires the eyes and causes the observer after prolonged programs to find his eyes recording drifting spot areas when viewing objects other than the picture. This phenomenon does not occur with the mechanical system, that is to say, with the mechanical system the physiological effect is the same as that resulting from viewing an ordinary black and white motion picture.

Generally the lighting problem favors the mechanical system in respect to the unit screen brilliancy for equal screen areas, the amount of broad-band power required for a given illumination, the life of the respective screen element, the potentials that must be generated by the amplifier, and the physiological effect.

Please Say That You Saw It in RADIO-CRAFT



**SCANNING CIRCUITS AND SYNCHRONIZATION**

Both systems drive their scanning on amplifier power controlled by a modulation of the carrier wave. In the case of the cathode-ray system, the scanning is performed by applying 2 high potentials of the order of 1,000 V. to corresponding pairs of electrodes, or in other words by electrostatic control. In the mechanical system the scanning is performed by supplying 2 magnet systems with a predetermined number of ampere turns excited at potentials of the order of only 10 V.! It is much less expensive to construct supply circuits of low voltage than it is to build corresponding circuits of high voltage.

But there is a more basic difference involved. The cathode-ray beam is practically inertialess and follows exactly the shape of the wave impressed upon its control electrodes. If this waveform varies from the pattern employed at the transmitter a corresponding picture distortion is introduced.

In the vibratory-mechanical system the motion is harmonic as are all of man's other recurring, predefined, constant-time-interval mechanisms. The scanners have an inherent period in each direction, dependent upon the designed moment of inertia and cooperating elasticity of each of the systems of motion. In operation they have a comparatively tremendous amount of energy stored up when compared to the increment of energy supplied by each driving pulse. They automatically tend to keep in step with the transmitter, and the waveform of their driving power is of no consequence upon the matter of picture distortion due to this great energy storage. It must be borne in mind if there is a slight difference in the natural periods of the scanners, that under the influence of a driving pulse on each swing, they will follow the period of the driving pulse and not their own, slightly off-resonance natural period. With a control of amplitude and phase at the receiver an exact framing and synchrony can be obtained.

The type of driving power favors the mechanical system. Furthermore, in spite of the variations that may be introduced by off-resonance, which variations can be compensated for at the receiver, the inertia inherent to the mechanical system eliminates a cause of distortion to which the cathode-ray system is sensitive—that of reproducing every slight ripple and surge in the base timing (scanning) voltage—because its beam lacks elasticity and inertia.

**COMPARATIVE COSTS**

It is not quite in balance to compare the cost of a small cathode-ray picture with the cost of the large picture produced by the mechanical system. However, cost is a vital factor and must be considered at least on the basis of the physical receivers that both systems propose to offer the public.

Starting with the scanner, the cathode-ray tube, like an incandescent lamp, is consumed while it operates. The vibratory-mechanical scanner, somewhat like a telephone receiver, has an almost unlimited long life. It has no bearings or sliding parts. The factory cost of the former including shrinkage is about \$20.00 and the latter about \$4.00.

The amplifier for the cathode-ray tube must supply 3 high-voltage circuits with accurate waveform power, with one of the circuits drawing all the lighting energy at frequencies between the bottom of the range and say 2 megacycles. The amplifier for the mechanical system likewise has 3 circuits, but only one of these must be of high fidelity over a broad band and that one is of medium output and voltage. The other two circuits are very low voltage and can be of any waveform. I would roughly estimate the cathode-ray system amplifier at about 3 times the cost of the amplifier for the vibratory-mechanical system. The latter should cost about \$45.

In addition to this equipment the mechanical system requires a source of light, a Kerr cell and a screen. These items should cost about \$10.

To sum up, the retail selling price of a cathode-ray receiver for a small picture, that is to say 6 x 8 ins. would be about \$550. The retail selling price for a mechanical system receiver producing a 3 x 3 ft. picture would be about \$200.

**GENERAL**

In the technical and commercial race between the two systems, the mechanical has the distinct advantages of picture size and cost. But what of the fragility of the big and expensive cathode-ray tube, and the danger of bringing high-voltage circuits in the home where busy little mischievous hands may cause tragedy? (This possibility is minimized in commercial practice by incorporating switches that automatically disconnect all high voltages whenever the doors to their housings are opened.—Editor) The cathode-ray television system is a monumental achievement, created from the contributions of numerous talented engineers and inventors with the expenditure of many millions of dollars. But in my opinion, although it is a rare technical success it is not a commercial answer to the problem, but more accurately a bridge from the pioneer Nipkow rotors to the vibratory-mechanical scanner.

Looking ahead, I expect commercial television in the home in color. Can the cathode-ray system look forward with confidence to the development of a picture in color with commercial home apparatus? (See "Color Television with Cathode-Ray Tubes!", pg. 105, in the article by Allen B. Dumont that appeared in the August 1935, Television Number of Radio-Craft.—Editor) The mechanical scanner can do the job with the use of 2 carriers and a single scanner!

**THE "TRANSCRYPTOR"**

(Continued from page 83)

a trifle larger than a portable typewriter.

**CIRCUIT DESIGN**

Electrically, the transcryptor comprises 4 tubes in a tested and thoroughly reliable circuit combination. As shown in the circuit diagram, Fig. 1, tube V1, a type 30, functions as a self-quenching super-regenerating detector, operated with a separate receiving antenna. When the 3-position switch Sw. is thrown to the position marked "R" (receiving) transformer T1 operates as a

straight A.F. amplifying transformer, working into tube V2, also a type 30. This tube works into a class B push-pull stage of A.F. amplification, which comprises transformers T2 and T3, and a type 19 tube. The receiver portion of the hand-set connects directly to the secondary of output transformer T3.

When change-over switch Sw. on the front panel is thrown to the "S" or transmitting (send) position, type 19 tube V4 operates as a unity-coupled push-pull R.F. oscillator. The

(Continued on page 128)

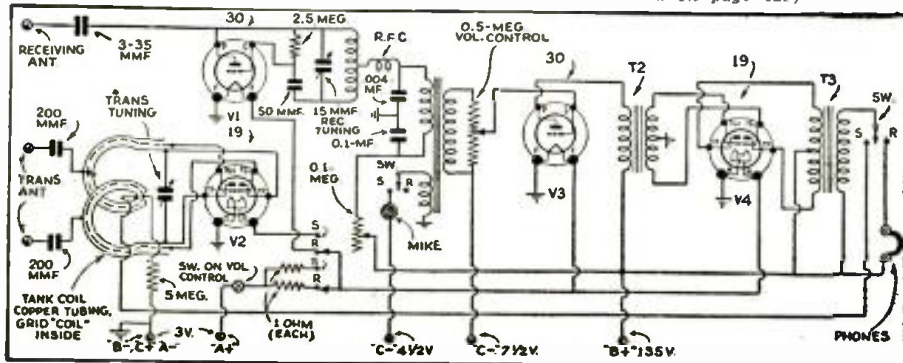

Fig. 1. The circuit of the Transcryptor for use on 56 mcs. (5 meters).

Please Say That You Saw It in RADIO-CRAFT

**Send for Both!**  
 1936  
 ALLIED RADIO  
 FREE  
 1 POLITICAL P. A. SALES BULLETIN  
 2 136 PAGE CATALOG...  
 RADIO'S LEADING SUPPLY GUIDE

Send for both! A punchy, sales-promoting Political P.A. Bulletin timed for the coming campaigns—and a great 136-page Radio Catalog featuring everything in Radio—sets, parts, books, tools, etc. Send for both—they're FREE and they're Hot! Write today.

**ALLIED RADIO**

833 W. Jackson Blvd. Dept. D  
 Chicago, Ill.

- Send me your FREE Political P.A. Bulletin.
- Send me your FREE 136-page Catalog.

Name .....

Address .....



**Precision CAPACITOR ANALYZER**

Capacity, power factor, leakage, resistance, directly on the panel. Highly sensitive No. 6E3 cathode ray tube used for balancing. Dials color-coded to match settings. A retuned and extended Wien bridge, instantly usable in shop and field. Two models, low priced.

QUICK as a WINK!  
 write for full details

**SOLAR MFG. CORP.**  
 599-601 BROADWAY NEW YORK CITY

**HAVE YOU SOME SPARE ROOM**

a basement or garage where you can do light work? We can offer you a profitable proposition for 1936 casting 5 and 10c Novelties, Ashtrays, Toy Automobiles, etc., as Branch Manufacturer for a firm of many years standing. No experience necessary and small outlay starts you so if you mean strictly business and are interested in devoting your spare or full time to profitable work write at once for full details.  
**METAL CAST PRODUCTS CO. Dept. 26**  
 1696 Boston Road New York, N. Y.

**RADIO ENGINEERING**

RCA Institutes offers an intensive course of high standard embracing all phases of Radio. Practical training with modern equipment at New York and Chicago schools. Also specialized courses and Home Study Courses under "No obligation" plan. Catalog, Dept. ET-36.

**RCA INSTITUTES, Inc.**  
 75 Varick St., New York 1154 Merchandise Mart, Chicago  
 Recognized Standard in Radio Instruction Since 1908

### Tune with Your Eye



An "RCA Cathode Ray Kit," easily installed on any receiver having Automatic Volume Control, makes your set tune like a '36 model. Kit, including tube, socket, escutchion, cable, everything needed, only \$3.00. Stock No. 9688.

### New RCA Spiderweb Antenna

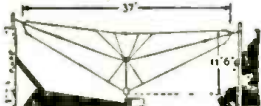

Gives improved pick-up on all bands with noise-reduction on short waves. Functions as a T from 140 to 4,000 kc., multiple tuned doubler 4000 kc. to 23 megacycles. Completely assembled, soldered, \$8.95. Stock No. 9685. Kit extending range to 70 mcs., \$1.50. Stock No. 9689.



See your dealer or write to Parts Division

**RCA Manufacturing Co., Inc.**  
Camden, New Jersey  
A Service of Radio Corporation of America

## THE "TRANSCPTOR"

(Continued from page 127)

microphone part of the hand-set is connected in series with a special primary on transformer T1, which thus acts as a microphone-coupling transformer. Tubes V2 and V3 then function as voice amplifiers, with tube V3 further operating as a modulator tube. The secondary of transformer T3 is thrown in series with the "B+" lead to oscillator tube V4, and thus modulates the R.F. output of the latter, accomplishing the phenomenon of radio telephony.

When change-over switch Sw. is thrown to the transmitting position it opens the filament to receiving tube V1, thus preventing additional modulation of the transmitter by incoming signals. Resistors provided in the filament circuit compensate for the slight voltage differences that occur between the receiving and transmitting circuit combinations.

A 0.5-meg. potentiometer connected across the secondary of transformer T1 operates as a volume control in the receive position, and as a microphone gain control in the transmit position. A separate 0.1-meg. variable resistor in the plate circuit to tube V1 functions as a regeneration control.

As the front view of the transceptor indicates, separate tuning controls are provided for transmitter and receiver tuning. It is therefore possible to adjust the transmitter for maximum efficiency on any particular frequency and then to cover the entire band with the separate receiver control. That this is a huge improvement over ordinary transceiver operation will be readily evident to any person who has had experience with instruments of the latter type.

The inside view of the transceptor shows the neat and simple distribution of the various parts. The hand-set is in its own special compartment at the left, with tip-jacks provided for quick connection. There are no loose cords of any kind hanging from the front panel to interfere with the tuning manipulations. The left section of the chassis contains the receiver tube V1 and its own tuning system comprising a space-wound coil, and a tiny 10 mmf. variable condenser; beyond the partition, to the right are tubes V2, V3, and V4, and the heavy copper tubing, comprising the tank circuit of the push-pull oscillator. In the schematic diagram the dotted lines indicate insulated wire pulled through the tubing; this insulated coil represents the grid inductance, while the copper tubing is the plate inductance. Snap clips attached to the tank coil connect through fixed condensers to a pair of binding posts on the front panel, for eventual connection to any of the usual types of 5-meter antennas. The A.F. units and assorted fixed resistors and condensers are facing on the underside of the chassis. The various dry cells required for filament, grid, plate and microphone current supply fit snugly inside the bottom of the case.

The particular transceptor illustrated, is a 2-V. battery model. (Another model, undergoing completion, will use the identical mechanical layout but the 2-V. tubes will be replaced by tubes of the 6.3 V. series.) This model will be available for operation on a 6-V. storage battery, as in an automobile, with either batteries or a dynamotor for plate supply; or for 110-V. A.C. service with a specially-designed power pack that will fit in the space now occupied by the dry batteries. This will make a marvelous little compact 5-meter station for fixed use in the home or for semi-portable use outside.

The improved mechanical construction and electrical design, and exceptionally successful performance in thorough field tests, recommend this new transceptor to the experienced 5-meter operator who has wrestled with ordinary transceivers, and to the beginner who wants to get started on 5-meters with a versatile instrument of low cost.

This article has been prepared from data supplied by courtesy of Wholesale Radio Service Co.

## THE MAGIC MAGNET SPEAKER

This is the name of what is probably the first catalogue devoted exclusively to the description of loudspeakers using the new alloy called "Nipermag." These speakers are the product of the Cinaudagraph Corp.

Write to Radio-Craft for your copy of this catalogue—No. 1092.

## Index to Advertisers

<b>A</b>	
Aalloy Transformer Co., Inc.	106
Aerovox Corporation	117
Allied Radio Corporation	127
Amerite Corporation	114
Amplifier Co. of America	110
Arrow Sales Corporation	121
Autocrat Radio Co.	114
American Television Institute	106
<b>B</b>	
Burstein-Applebe Co.	106
<b>C</b>	
Capitol Radio Engineering Instit.	117
Central Radio Labs.	104
Cinaudagraph Corporation	125
Classified Section	122
Clough-Brengle Co.	115
Commonwealth Products Co.	125
Cornell-Dublier Corp.	121
Coyne Electrical School	65
<b>D</b>	
Dodge's Institute	110
Allen B. Dumont Labs., Inc.	112
<b>E</b>	
Electrad, Inc.	116
<b>F</b>	
Federal Engineering Co.	114
First National Television, Inc.	125
Franklin Transformer Mfg. Co.	102
<b>G</b>	
General Cement Mft. Co.	116
General Electric Company	Back Cover
Gillette Radio Corp.	108
Goldstone Radio Company	110
Greipark Company	118
<b>H</b>	
Hammard Mfg. Company	119
Hudson Specialties Co.	122
Hygrade-Sylvania Corp.	111
<b>J</b>	
Jobs & Careers	110
<b>K</b>	
Kato Engineering Co.	114
<b>L</b>	
Lincoln Engineering School	115
<b>M</b>	
Metal Cast Products Co.	127
Midwest Radio Corp.	Inside Back Cover
Million Radio & Tel. Labs.	116
<b>N</b>	
National Radio Institute	87
National Union Radio Corp.	105
<b>O</b>	
The Oxford-Tartak Radio Co.	112
<b>P</b>	
Precision Sound Labs.	112
<b>R</b>	
Racon Electric Co., Inc.	102
Radio & Technical Publ. Co.	110
Radio & Television Institute	116
Radio Circular Company	104
Radio City Products Co.	121
Radio Publications	124
Radio Training Assoc. of America	105
Radolek Company	128
RCA Institutes, Inc.	127
RCA Mfg. Company, Inc.	128
Readrite Meter Works	112
Remington Radio & Elec. Corp.	106
Remington Rand, Inc.	112
<b>S</b>	
S.O.S. Corporation	116
Sears, Roebuck & Co.	115
Solar Mfg. Company	127
Sprayberry Academy of Radio	114
Standard Transformer Corp.	116
Superior Instrument Co.	106
Supreme Instrument Corp.	Inside Front Cover
Supreme Sound Labs.	110
<b>T</b>	
Teleplex Company	114
The Plan Shop	115
Triplett Elect. Instr. Co.	109
Tri-State College	108
Tung Sol Radio Tubes, Inc.	119
<b>W</b>	
Wellworth Trading Co.	120
Weston Elect. Instr. Corp.	103
Wholesale Radio Service Co., Inc.	107
Wright-DeCoster, Inc.	123
<b>U</b>	
Zephyr Radio Company	116

(While every precaution is taken to insure accuracy, we cannot guarantee against the possibility of an occasional change or omission in the preparation of this index.)

## PUBLIC ADDRESS SALES PROMOTER

*With List Prices*

### Just Off the Press!



Another Radolek "Profit-builder" for you! A complete "Public Address Salesman." All prices are shown at your list selling prices. Show this book to your customers — it clinches the sale and protects your profits. Beautiful illustrations

—complete descriptions. 5 to 60 watts. Everything in P.A.

### Repair Parts Profit Guide

The new Radolek 1937 Radio Guide is completely revised—right up to the minute—everything in radio—at the right prices. Over 10,000 Repair Parts—a complete selection of Receivers, Amplifiers, Tubes, Tools, Books, Instruments—always in stock—ready for speedy shipment to you. You need this big Radio Parts Catalog. It's Free! Send for it.



## MAIL THIS COUPON!

### RADOLEK

606 W. RANDOLPH ST., CHICAGO

Send the Radolek Profit Guide Free   
Send the P.A. Sales Promoter Free

Name .....

Address .....

Service man?  Dealer?  Experimenter?

Please Say That You Saw It in RADIO-CRAFT

The Whole Family Will Thrill to the Glorious Reception of this **NEW 1937 AIR-TESTED MIDWEST**

Only **MIDWEST** gives you **16 TUBES...5 WAVE BANDS... 9 to 2200 METERS...ELECTRIK SAVER...PUSH BUTTON TUNING... AUTOMATIC AERIAL ADAPTION...DUAL AUDIO PROGRAM EXPANDER** and Scores of Other Features for only

**\$49.95** COMPLETE WITH GIANT THEATRE-SONIC SPEAKER  
(LESS TUBES)



**30 DAYS Free TRIAL!**

**TERMS AS LOW AS 10¢ PER DAY**

**SAVE UP TO 50% BY BUYING DIRECT FROM MIDWEST FACTORY**

ONCE again, Midwest demonstrates its leadership by offering the world's most powerful ALL-WAVE 16-Tube, 5-Band Radio. A startling achievement, it makes the whole world your playground. Powerful Triple-Twin tubes (two tubes in one!) give 18-tube results! It is a master achievement, a highly perfected, precisely built, radio-musical instrument that will thrill you with its marvelous super performance... glorious crystal-clear "concert" realism... and magnificent foreign reception. Before you buy, write for the FREE 40-page 1937 catalog. Never before so much radio for so little money. Why pay more?

No middlemen's profits to pay! Buying direct from the Midwest factory makes your radio dollar go twice as far. See for yourself that Midwest offers you greater radio value—enables you to buy the more economical factory-to-you way that thousands of radio purchasers have preferred since 1920.

You can order your Midwest 1937 radio from the new 40-page catalog with as much certainty of satisfaction as if you were to come yourself, to our great factory. (It pictures the beautiful 1937 Radios... in their actual colors!) You save 50% to 50%—you get 30 days free trial—and you pay as little as 10¢ a day. Satisfaction guaranteed or money back. Write today for FREE catalog.

**85 ADVANCED 1937 FEATURES**

This Super DeLuxe Midwest is so powerful, so amazingly selective, so delicately sensitive that it brings in distant foreign stations with full loud speaker volume on channels adjacent to powerful locals. Scores of marvelous Midwest features, many of them exclusive, make it easy to parade the nations of the world before you. You can switch instantly from American programs... to Canadian, police, amateur, commercial, airplane and ship broadcasts... to the finest and most fascinating foreign programs.



I AM TREMENDOUSLY IMPRESSED WITH THE REMARKABLE PERFORMANCE OF MY MIDWEST.....  
*Robert Montgomery*



MUSICIANS EVERYWHERE COMMENT ON THIS.... REMARKABLE INSTRUMENT  
*Johnny Green*



**Electrik-Saver Reduces Wattage Consumption 50%.** The magical exclusive Electrik-Saver enables Midwest radios to operate on low line voltage—as low as 80 volts!... and explains why they consume no more current than ordinary 7-tube sets. It is a real miser begrudging every penny's worth of current that flows through the meter.



**MAIL COUPON TODAY for Free 30-DAY TRIAL OFFER and 40-PAGE FOUR-COLOR Free CATALOG**

**MIDWEST RADIO CORPORATION**  
Dept. B-12 Cincinnati, Ohio  
Without obligation on my part, send me your new FREE catalog and complete details of your liberal 30-day FREE trial offer. This is NOT an order.

Special offer and prices prevail only when dealing direct with factory by mail.

Name \_\_\_\_\_  
Address \_\_\_\_\_  
Town \_\_\_\_\_ State \_\_\_\_\_

**MIDWEST RADIO CORP.**

DEPT. B-12  
Established 1920

CINCINNATI, OHIO, U.S.A.  
Cable Address MIRACO...All Codes

RESEARCH KEEPS GENERAL ELECTRIC YEARS AHEAD



*Focused Tone*

REVOLUTIONIZES TUNING  
- AUTOMATICALLY ASSURES  
PERFECT TONE

RADIO'S  
NEWEST  
MARVEL

Watch for Your  
Local G-E Radio  
Dealer's Display of  
G-E Focused Tone  
Radio Models  
Early in July

You'll ALWAYS Be Glad You Bought  
a General Electric Radio

GENERAL  ELECTRIC

*Focused Tone Radio*

APPLIANCE AND MERCHANDISE DEPARTMENT, GENERAL ELECTRIC COMPANY, BRIDGEPORT, CONN.